

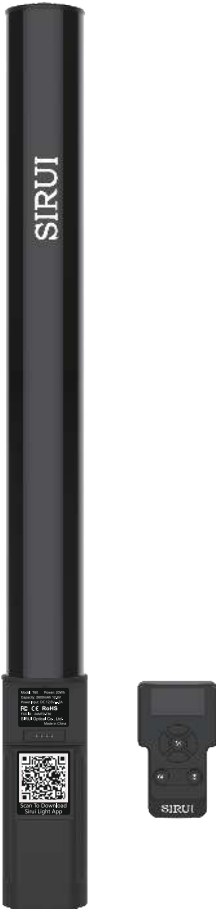

User Guide

Duken T60 Telescopic RGB LED Tube Light



Forward

This RGB LED Tube Light T60 is a telescopic RGB light with multicolor, dual color temperature and light effects mode. Suitable for almost all shooting occasions e.g. live, camping, portrait shooting, make up, video, wedding, children photography, etc., it's portable and easy to operate.

Features

- (1) Fashionable in appearance, intuitive in operation and portable in carrying.
- (2) Freely switch among LED CCT mode, RGB mode and 14 special effects mode.
- (3) Adjust color temperature, light brightness, hue and color saturation easily.
- (4) 20 sets of light parameters can be saved for direct use next time.
- (5) Blink and change colors with the rhythm of music.
- (6) Remote control by smartphone APP/2.4G wireless.
- (7) With built-in lithium battery, it can be charged through DC power jack.
- (8) Use in combination to make more creative light groups.

What's in the Box

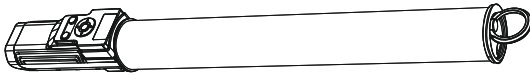

Body *1 (Remote Control*1)

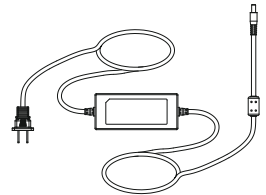

Adapter *1 (3.2m Cable *1)

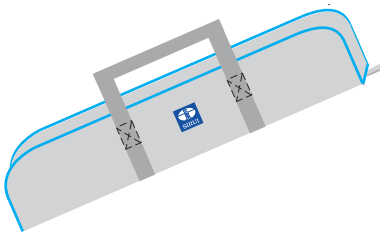

Carry Bag *1



Manual *1



Mini Tripod*1

Names of Parts

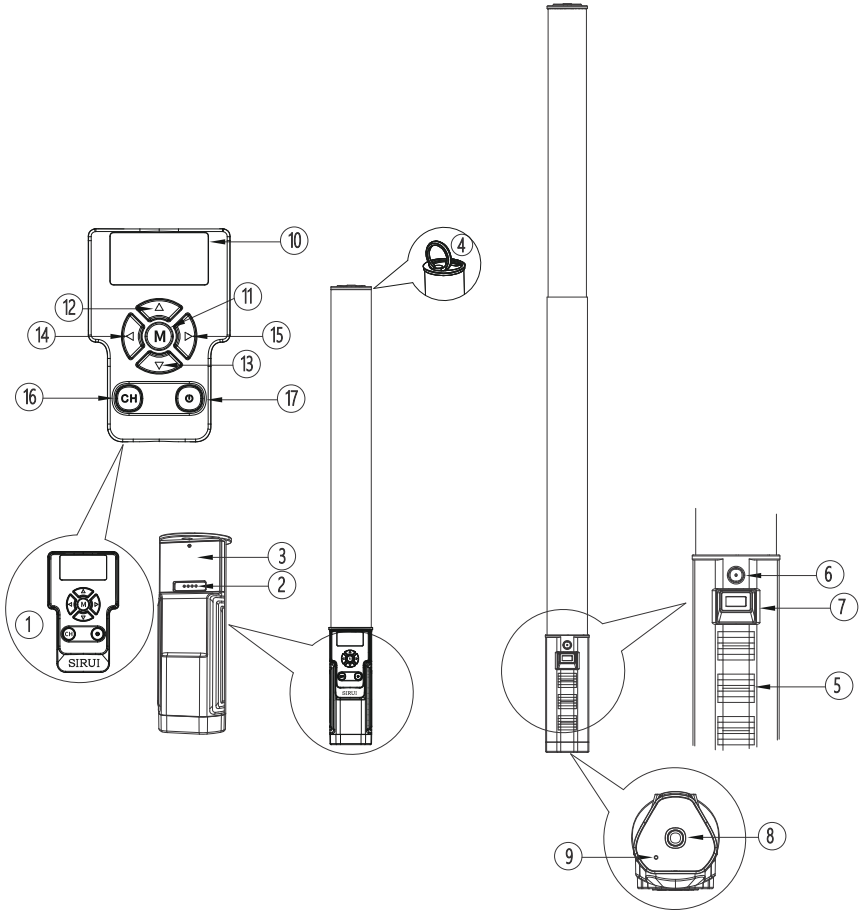

1	Remote Control	10	Display Screen
2	Remote Control Contact	11	Mode Button
3	Slot	12	Up Button
4	Pull-Tab	13	Down Button
5	Grip	14	Left Button
6	DC Power Jack	15	Right Button
7	Power Switch	16	Channel Switch Button
8	1/4" Screw Hole	17	Remote Control Power Switch
9	Soundhole Pickup		

Battery Management

1、Charge

It is recommended to use the provided DC power adapter to fully charge the product before use. It takes about 1.5h to charge the video light. While charging, the power adapter displays a red light to indicate that it is charging, and a green light to indicate that it is fully charged. (Note: Please use recommended adapters for charging, use of other power adapters may void the warranty).

2、Power Supply

There is a built-in lithium battery in the video light, which supports a 2-hour runtime at full power when fully charged. Connect the video light to the DC power adapter for long-time working.

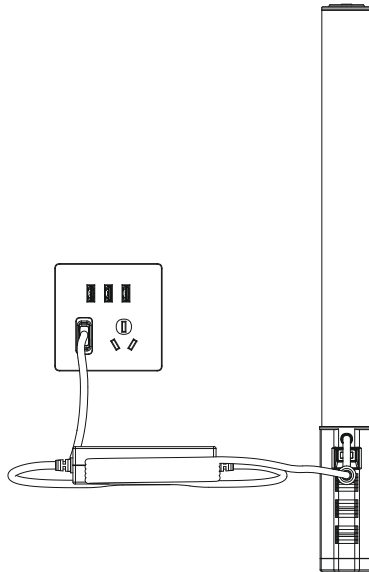

1、 Operation

1.1 Power Switch

Use the power switch to control the on or off of the RGB tube light.

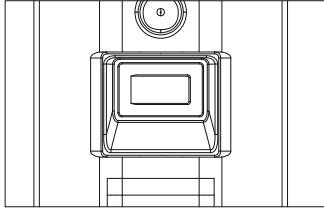

1.2 Turn on/off the remote control and match the channel.

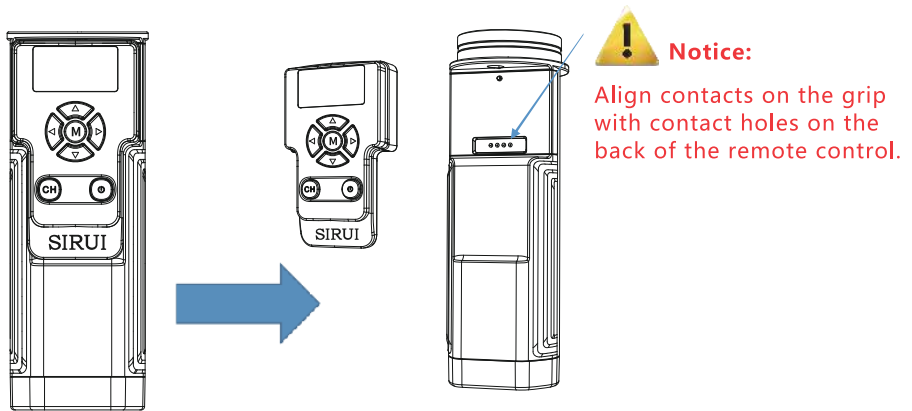

- 1.2.1 Press and hold the power button on the remote control for 2s to turn on/off the remote control.
- 1.2.2 Put the remote control into the slot, and the channel of the video light will synchronize with that of the remote control.
- 1.2.3 After matching, single press the remote control power button to turn on/off the light (Note: remote control power button is for temporary use only. Please turn off the remote control if you want to turn off the light for a long time).
- 1.2.4 The remote control can either be put into the slot or be removed to control the light remotely.

1.3 Telescopic Tube Light

- 1.3.1 Extension: Hold the grip with your left hand, and pull the pull-tab on the upper end of the light with your right. The light will not light up until it is pulled to the end.
- 1.3.2 Retraction: Hold the grip with your left hand, and press down the light from the upper end with your right. The retracted tube will automatically go out.

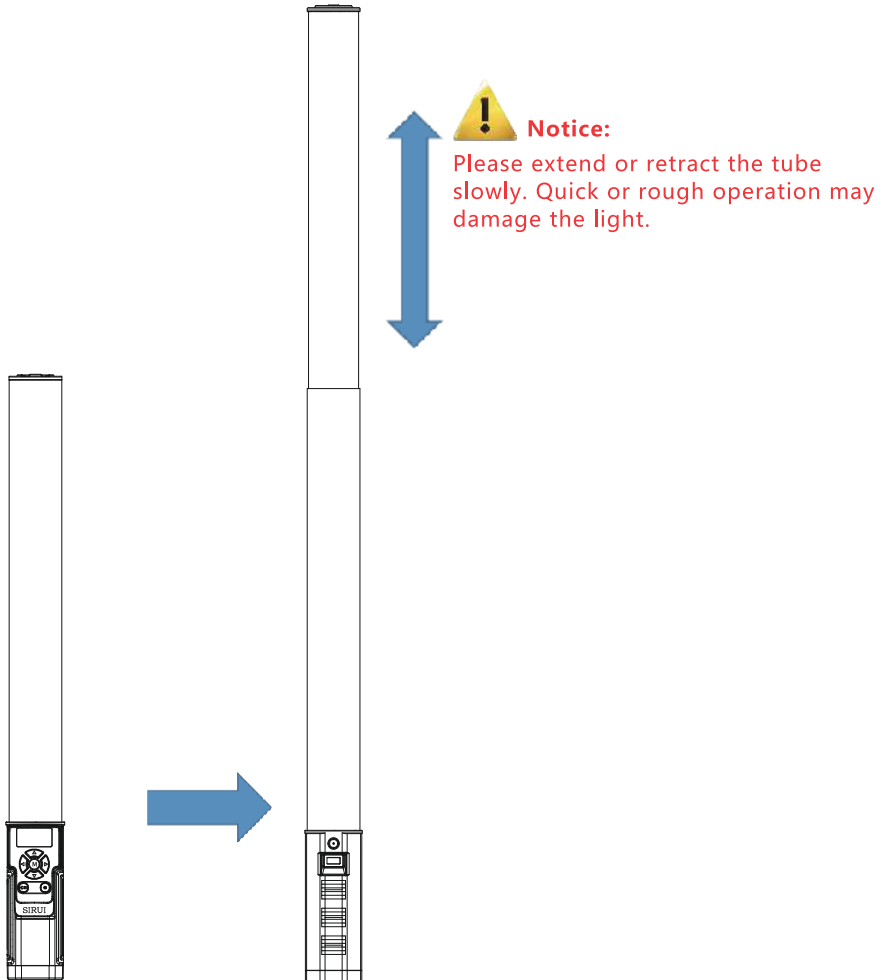

1.4 Remote Control

Mode Selection: CCT Mode/ Colorful Mode/ Light Effects Mode

Tap the M button to switch among different modes:

CCT means bi-color mode

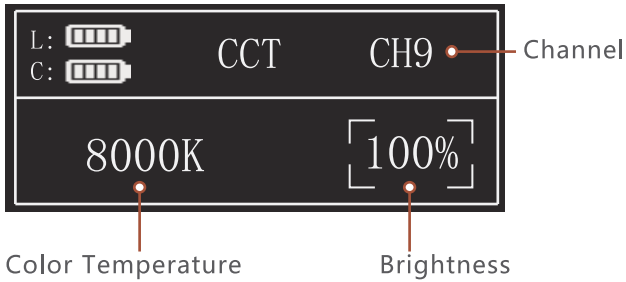

HSI means colorful mode

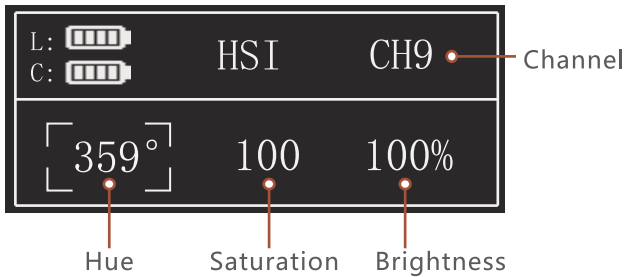

FX means light effects mode, and icons will be displayed.

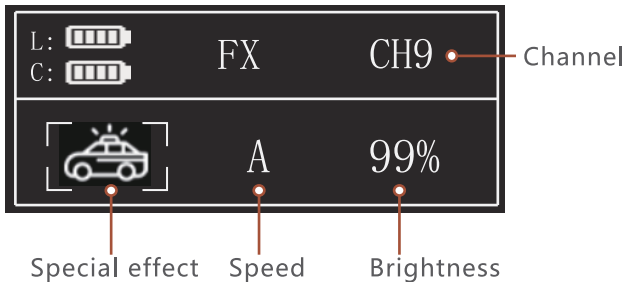

2、Modes

2.1、CCT Mode

- 2.1.1 Tap the Left/Right Button to choose the value (CCT or INT) to be adjusted.
- 2.1.2 Color temperature adjustment: press the Up Button to increase the color temperature value and the Down Button to decrease. Tap the button once and the color temperature value will changes in 50K. Long press the button to adjust the value from 2500K to 8000K quickly.
- 2.1.3 Brightness adjustment: press the Up Button to increase the brightness value and the Down Button to decrease. Tap the button once and the color temperature value will changes in 1%. Long press the button to adjust the value from 0% to 100% quickly.
- 2.1.4 CCT storage: long press the M Button for two seconds to enter the CCT Save/Read interface.

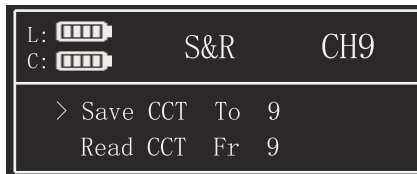

- 2.1.4.1 Press Up/Down Button to select Save/Read.
- 2.1.4.2 Press the Left/Right Button to select the corresponding serial number to Save/Read.
- 2.1.4.3 Press the M Button to save a parameter after you choose "Save" (10 sets of parameters can be saved). If you select the serial number of an existing parameter during storage, the parameter will be overwritten. Press the M Button to read a specific parameter after you choose "Read".

2.2、Colorful Mode

- 2.2.1 Tap the Left/Right Button to choose the value (HUE, SAT, INT) to be adjusted.
- 2.2.2 Hue adjustment: press the Up Button to increase the hue value and the Down Button to decrease. Tap the button once and the hue value will changes in 1°. Long press the button to adjust the value from 0° to 359° quickly.
- 2.2.3 Saturation adjustment: press the Up Button to increase the saturation value and the Down Button to decrease. Tap the button once and the saturation value will changes in 1. Long press the button to adjust the value from 0 to 100 quickly.
- 2.2.4 Brightness adjustment: press the Up Button to increase the brightness value and the Down Button to decrease. Tap the button once and the brightness value will changes in 1%. Long press the button to adjust the value from 0% to 100% quickly.
- 2.2.5 HSI storage: long press the M button for two seconds to enter the HSI Save/Read interface.



- 2.2.5.1 Press Up/Down Button to select Save/Read.
- 2.2.5.2 Press the Left/Right Button to select the corresponding serial number to Save/Read.
- 2.2.5.3 Press the M Button to save a parameter after you choose "Save" (10 sets of parameters can be saved). If you select the serial number of an existing parameter during storage, the parameter will be overwritten. Press the M Button to read a specific parameter after you choose "Read".

2.3、 Light Effects Mode

- 2.3.1 Tap the Left/Right Button to choose from EFFECT, Gear and INT.
- 2.3.2 Light Effects: press the Up/Down Button to choose from the 14 effects.
- 2.3.3 Gear adjustment: press the Up/Down Button to shift from three gears (A, B, C).
- 2.3.4 INT adjustment: press the Up Button to increase the INT and the Down Button to decrease. Tap the button once and the INT will changes in 1%. Long press the button to adjust the value from 0% to 100% quickly.
- 2.3.5 There' re 39 kinds of situational special effects mode which are divided into 14 categories for your choice:

No.	Display	Light Effects	Display A	Display B	Display C
1		RGB Recycle	Slow	Medium	Fast
2		Flash	Flash	Fashion Show	Paparazzi
3		Disco	Birthday Party	KTV	Disco
4		Lightning	Intermittent	Frequent	continuous
5		Fault light	Intermittent	Frequent	continuous
6		TV	Slow	Medium	Fast
7		Candle	Intermittent	Frequent	continuous
8		Fire	Log Fire	Bonfire	Fire
9		Firework	Brief	Continuous	Display
10		Police Car	Fast	Medium	Slow
11		Fire Truck	Fast	Medium	Slow
12		Ambulance	Fast	Medium	Slow
13		Music	Music1	Music2	
14	SOS	SOS			

2.4、 Channel Settings

2.4.1 Put the remote control into the card slot, and the channel of the video light will synchronize with that of the remote control.

2.4.2 Short press CH button to switch to your desired channel. When the controller is taken off, the channel of the video light remains consistent with that of the controller. For example, if the channel of the controller is switched to CH5, the channel of the video light will be the same. To switch the channel of the video light, the remote control should be inserted into the card slot first.

2.4.3 If you own several T60 RGB lights, you can group control their brightness and switches (groups at most are 10).

2.4.4 The LCD screen can display ten channels (CH0 to CH9), and you can switch channels by short pressing the CH button.

3、 Battery Level

3.1 Turn on both the video light and the remote control. Insert the remote control into the slot (the video light will charge the remote control), L and C on the LCD display indicate the battery level of the video light and remote control respectively (turn on the video light before charging the remote control).

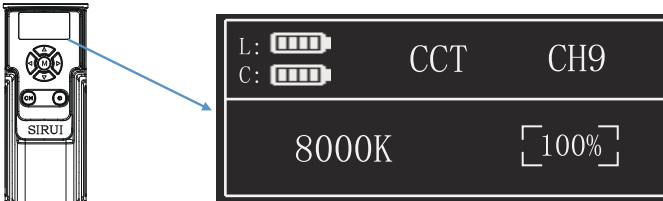

When the remote control is turned off for charging.



3.2 Remove the remote control. The LCD display indicates the battery level of the remote control itself (C).

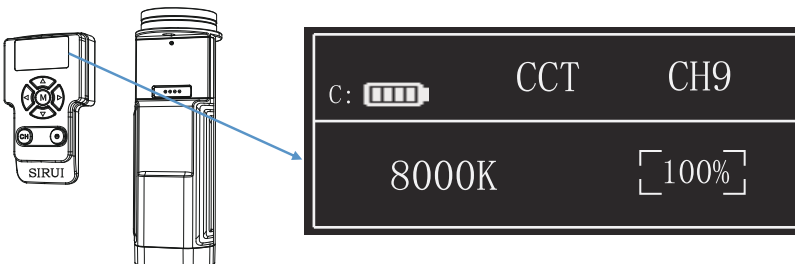

4、 Connect with Smartphone APP

Scan the QR code to download the "SIRUI Light" APP.



For more smartphone APP operations, please click "help" in APP to gain detailed guidance.

5、 Installation and Fixing

You can install the video light as shown in the figure below.
Fasten the video light to the tripod directly.

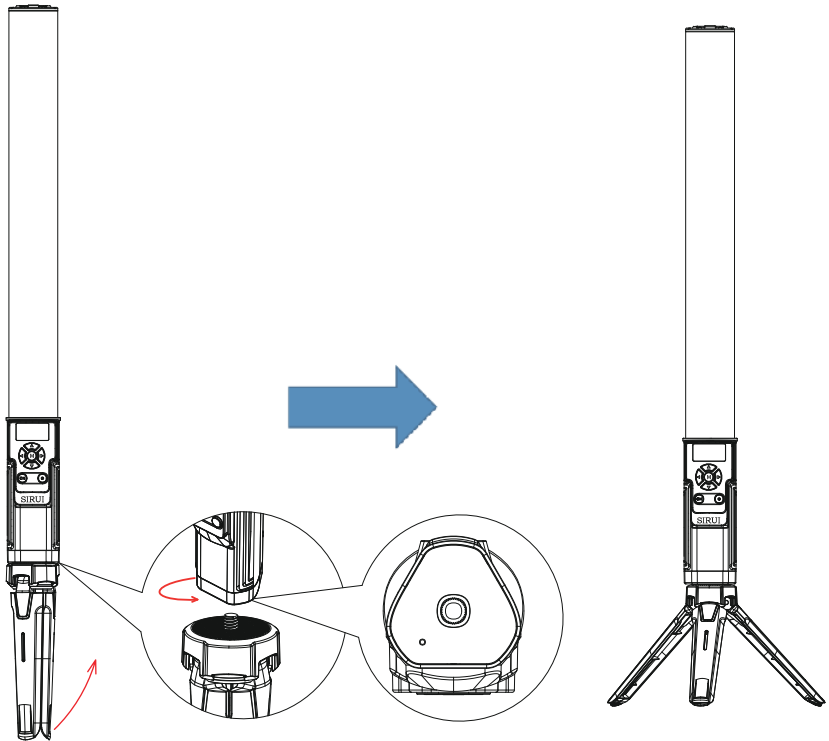

Technical Data

Model	T60
Dimensions	Retracted : $\varphi 42 \times 455 \text{mm}$; Extended : $\varphi 42 \times 740 \text{mm}$
Weight	Approx. 658g
Built-in Lithium Battery	3*2600mAh 3.7V
Adapter	12.6V 2A
Charge Time	1.5H
Charging Port	DC Power Jack
Power	Max. 20W
Color Temperature Range	2500K~8000K
RGB Color Gamut	0-359°
Light Effects	14 Categories
Illuminance	0.5m 1000lux
Illumination Distance	3-5m
TLCI	97
CRI	97
Brightness Range	0%-100%
Duration(continuous output in 100% full power)	2H
Operation Temperature	-10°C-45°C
Control Method	Smartphone APP/2.4G Wireless
Bluetooth Wireless Control Distance	15m
Remote Control Distance	15m
Channel	10

* Product design and specifications are subject to change without notice.

Battery

1. This video light has a built-in 2600mAh lithium battery, which is non-removable.
2. The battery is reliable. The inner circuit is against overcharge, overdischarge, overcurrent and short circuit.
3. Use the provided adapter to charge the battery. The indicator on the adapter turns from red to green means the battery is fully charged. Using while charging is allowed.

Cautions

1. Do not charge the battery for over 24 hours.
2. Store in dry, cool, ventilated places.
3. Do not put the battery near the fire.
4. Please charge the battery to 70% before setting it aside for a long time.
5. If the battery has ceased using for over 3 months, please make a full recharge.
6. It is normal that the battery performance degrades after using for a certain period of time.
7. Dead batteries should be disposed according to local regulations.
8. Use recommended adapters to charge the battery. Use of other adapters may void the warranty.

Maintenance

1. Shut down the device immediately should there any abnormal occur.
2. Avoid sudden impacts and the product should be dedusted regularly.
3. It is normal for the light beads to be warm when in use.
4. Maintenance of the light must be performed by authorized maintenance department which can provide original accessories.
5. This product, except consumables, has a one-year warranty. Lithium battery has six months warranty.
6. Unauthorized service will void the warranty.
7. If the product has failures or is wet, do not use it until it is repaired by professionals.
8. Specifications or designs are subject to change without prior notice.

Warnings

1. As this product is not waterproof, please take waterproof measures in rainy or damp environment.
2. Please keep the product dry. Do not touch the product with wet hands, immerse it in water or expose it to rain.
3. Do not use this product in the presence of flammable gases, chemicals and other similar materials. In certain circumstances, these materials may be sensitive to the strong light emitting from this product and fire or electromagnetic interference may result.
4. As this product has a built-in lithium battery, do not disassemble, impact, squeeze it or put it into fire. If serious bulge occurs, please stop using it.
5. Do not place the product in an environment where the temperature exceeds 50°C. Please charge the product with included adapter and operate it properly within the defined voltage and working temperature.
6. Please don't look directly at the light when it is working.