

SmallRig

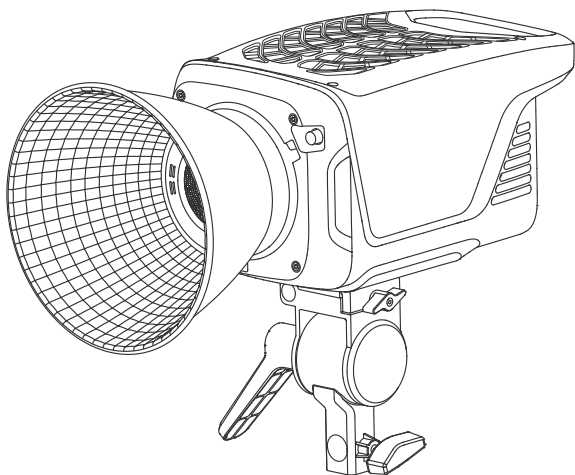

RC 350B / RC 450B
COB LED Video Light
- User Manual -

Foreword

Thank you for choosing SmallRig COB LED Video Light.

Warnings

1. Please read this User Manual carefully.
2. Keep this User Manual and always include it when passing the product onto the third party.
3. Heed all warnings and follow all instructions in this User Manual.
4. Close supervision is necessary when any fixture is used by or near children. Do not leave the fixture unattended while in use.
5. Care must be taken as burns can occur from touching hot surfaces.
6. Do not operate the fixture if a cord is damaged or if the fixture has been dropped or damaged until it has been examined by qualified service personnel.
7. Position any power cables so that they will not be tripped over, pulled or put into contact with hot surfaces.
8. If an extension cord is necessary, a cord with an amperage rating at least equal to that of the fixture should be used. Cords rated for less amperage than the fixture may overheat.
9. Always unplug the lighting fixture from the electrical outlet before cleaning and servicing or when not in use. Never yank the cord to remove the plug from the outlet.
10. Let the lighting fixture cool completely before storing.
11. To reduce the risk of electric shock, do not immerse this fixture in water or any other liquids.
12. To reduce the risk of fire or electric shock, do not disassemble this fixture. Contact smallrig@smallrig.com or take it to qualified service personnel when service or repair work is required.
13. The use of an accessory attachment not recommended by the manufacturer may increase the risk of fire, electric shock, or injury to any person operating the fixture.
14. Power this fixture by connecting it to a grounded outlet.
15. Please remove the protection cover before powering the light.
16. Please remove the EVA protection cover before using the reflector.
17. Please do not block the ventilation and do not look at the light directly when it is powered on.
18. Please do not place the LED lighting fixture near any liquids or other flammable objects.
19. Only use a dry microfiber cloth to clean the product.
20. Please have the product checked by an authorized service personnel agent if your product has a problem.
21. The malfunctions caused by unauthorized disassembly are not covered under the warranty.
22. We recommend only using the original SmallRig cable accessories. Please note that our warranty for this product does not apply to any repairs required due to any malfunctions of unauthorized SmallRig accessories, although you may request such repairs for a fee.
23. This product is certified by CE, RoHS, UKCA, FCC, IC, KC, RCM, TELEC, PSE. Please operate the product in full compliance with the operation standards. Please note that this warranty does not apply to repairs arising from malfunctions, although you may request such repairs on a chargeable basis.
24. The instructions and information in this manual are based on thorough, controlled company testing procedures. Further notice will not be given if the design or specifications change.



Please do not disassemble the product. If you have any question, please contact the seller to apply after-sales service.

FCC Compliance Statement

This device complies with Part 15 of the FCC Rules. Operation is subject to the following two conditions:

- (1) This device may not cause harmful interference.
- (2) This device must accept any interference received, including interference that may cause undesired operation.

[Warning]

Changes or modifications not expressly approved by the party responsible for compliance could void the user's authority to operate the equipment.

[Note]

This equipment has been tested and found to comply with the limits for a Class B digital device, pursuant to Part 15 of the FCC Rules. These limits are designed to provide reasonable protection against harmful interference in a residential installation. This equipment generates, uses and can radiate radio frequency energy, if not installed and used in accordance with the instructions, may cause harmful interference to radio communications.

However, there is no guarantee that interference will not occur in a particular installation. If this equipment does cause harmful interference to radio or television reception, which can be determined by turning the equipment off and on, the user is encouraged to try reorient or relocate the receiving antenna.

- Increase the separation between the equipment and receiver.
- Connect the equipment to an outlet in a different circuit than the receiver is connected to.
- Consult the dealer or an experienced radio / TV technician for help.

FCC ID: 2AZWI-3960LEQI

RF Warning Statement

The equipment complies with FCC Radiation exposure limits set forth for uncontrolled environment. This equipment should be installed and operated with minimum distance 20cm between the radiator and your body.

In the Box

When you unbox the product, please make sure all the items below are included. Otherwise, contact with the seller immediately.

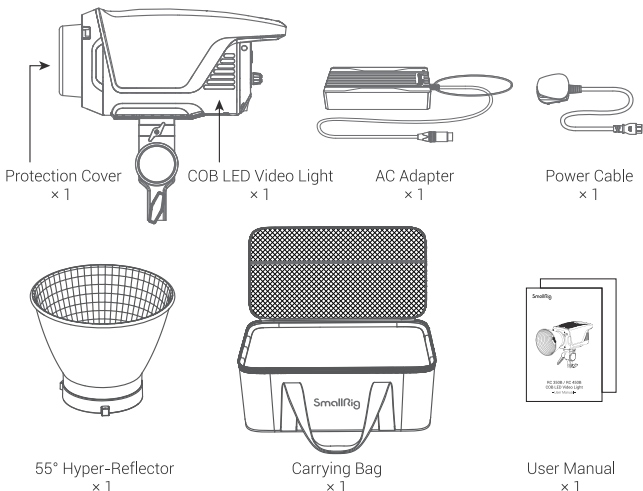

Product Details

Light

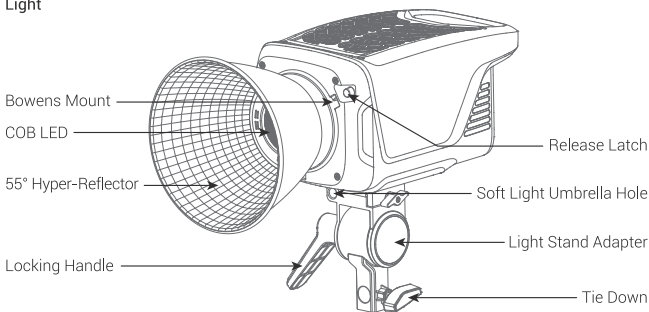

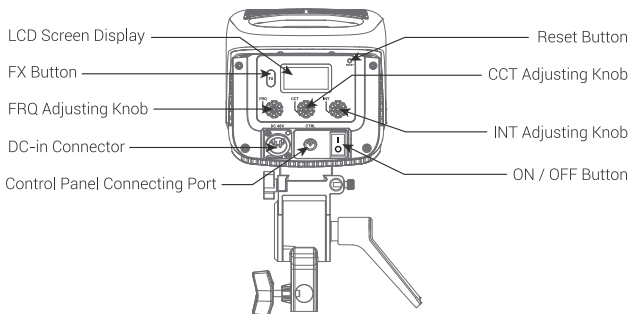

Installations

1. Attaching / Detaching the protection cover

Push the handle of the lever in the direction of the arrow shown in the picture, and rotate the cover to pull it out. Reverse rotation will put into the protection cover.

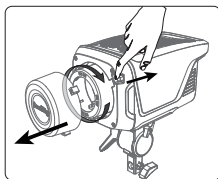
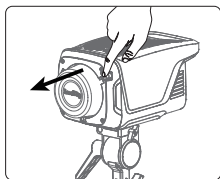

* Notice: Always remove the protection cover prior to turning on the light.
Always reinstall the cover when packing it away.

2. Installation and removal of the reflector

Push the lever handle according to the arrow direction shown in the picture and rotate the reflector into it. Rotating in the opposite direction pulls out the reflector.

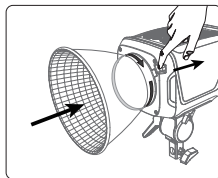
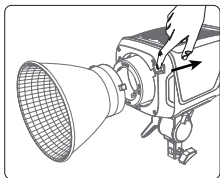

* Notice: The installation of other Bowens Mount modifiers are the same.

3. Setting up the light

Connect and tighten the stand adapter with the light through the Arca-type clamp and mount plate, rotate the tie-down knob to fix the stand adapter on the light stand. Please remember to lock the stand adapter with the locking handle once you've adjusted the light to the required angle.

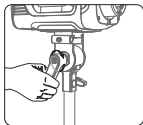
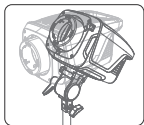
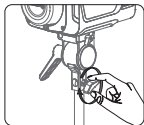
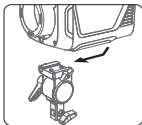

4. Soft light umbrella installation

Insert the soft light handle into the hole and lock the knob on the hole.

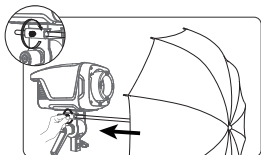
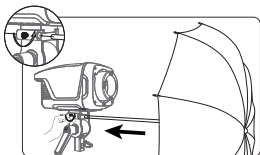

The Power Supply

Powered by AC

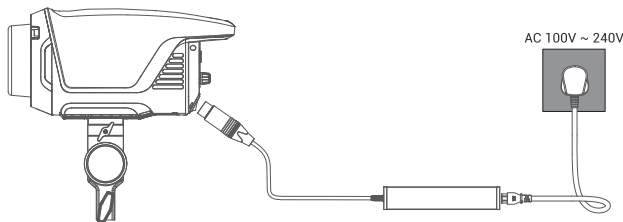

* Notice: Please press the spring-loaded lock button on the power cord to remove the cord. Do not pull it out forcibly.

Operations

1. Press the power button to turn the light on and off.

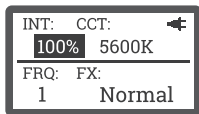
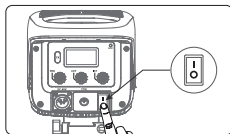

2. Manual control

2.1 Brightness adjustment

Rotate the INT adjusting knob to adjust the brightness with 1% variable and the brightness change range is 0 ~ 100%, the change of the brightness will be displayed in real time on the light body.

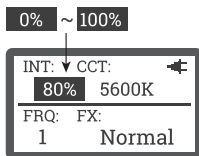
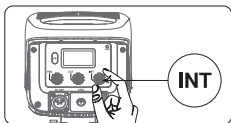

2.2 Color temperature adjustment

Rotate the CCT knob to adjust the color temperature, and the CCT range is 2700K ~ 6500K.

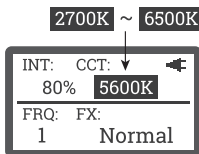
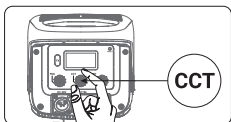

2.3 FX and FRQ adjusting control

- Press the FX button to get Normal and Paparazzi / TV / Fault Bulb / Lightning / Breath / Party / Flash / Flame / Firework, nine kinds of FX.
- Rotate the FRQ knob then switch to the frequency adjustment, the change range is 1 ~ 10.

* Notice: The brightness and FRQ of every FX can be set separately.

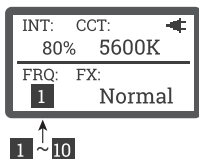
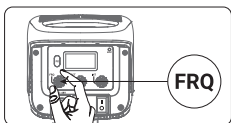
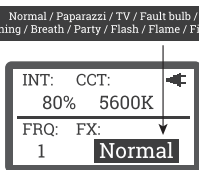
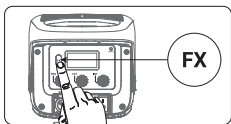

3. BLE reset

- 3.1 Long press the Reset button for 3 seconds, the BLE icon will appear in the upper right if the LCD display. The icon flashes 6 times and the BLE is reset.
- 3.2 Then you can reconnect the light through SmallGoGo App on your smart device.

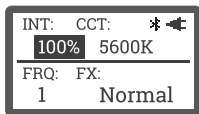
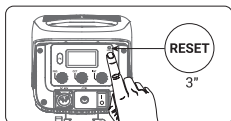

4. App control

The user can download the SmallGoGo App and connect the the device named 350B-xxxxxx / 450B-xxxxxx.

After the light is controlled by the App, the BLE icon will be displayed on the upper right of the light LCD.

* Notice: Please enable the mobile location function when using the App.

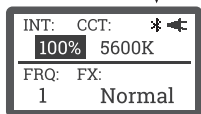

* Please visit www.smallgogo.com for more details regarding how to use the App to control you lights.

5. OTA mode

Firmware updates can be updated online via the SmallGoGo App for OTA updates.

6. Using the SmallGoGo App

You can download the SmallGoGo App from the iOS App or Google Play Store for enhancing the functionality of the light. Please visit www.smallgogo.com for more details regarding how to use the app to control your lights.



Operation Manual



App Download

7. Panel control

- a. Connect the control panel with the light.
- b. The operation interface is the same as that on the light.

* Notice: The control panel is not standard configuration and need to buy separately.

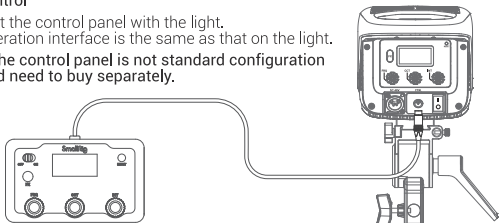

Specifications

Light Operating Current	8.4A @ 48V	Power Consumption	403.2W
Light Power Supply	DC 48V	Cooling Mode	Active Cooling
Adapter Power Supply	AC100 ~ 240V 50 / 60Hz	CRI	96+
TLCI	97+	App Control Type	BLE
Color Temperature	2700K ~ 6500K(±200K)	Remote Ability	≤100m
Radio Frequency	2.4GHz	Power Supply	AC
Size	11.43 × 5.7 × 5.7in	Weight	7.27 Pound

Photometrics

CCT / INT	Distance			
	Illumination	1m	3m	5m
2700K	Bare Bulb	903 fc	100 fc	37 fc
		9720 lux	1080 lux	400 lux
	Hyper-Reflector	6942 fc	540 fc	183 fc
		74700 lux	5810 lux	1970 lux
3200K	Bare Bulb	1171 fc	130 fc	48 fc
		12600 lux	1400 lux	520 lux
	Hyper-Reflector	9061 fc	708 fc	239 fc
		97500 lux	7620 lux	2570 lux
4800K (MAX lux)	Bare Bulb	1468 fc	164 fc	61 fc
		15800 lux	1770 lux	660 lux
	Hyper-Reflector	11524 fc	907 fc	303 fc
		124000 lux	9760 lux	3260 lux
5600K	Bare Bulb	1366 fc	151 fc	57 fc
		14700 lux	1630 lux	610 lux
	Hyper-Reflector	10688 fc	835 fc	281 fc
		115000 lux	8980 lux	3020 lux
6500K	Bare Bulb	1208 fc	133 fc	50 fc
		13000 lux	1430 lux	540 lux
	Hyper-Reflector	9387 fc	736 fc	248 fc
		101000 lux	7920 lux	2670 lux

* This is an averaged result, the number might be slightly different on each light.

Specifications

Light Operating Current	10.2A @ 49V	Power Consumption	499.8W
Light Power Supply	DC 49V	Cooling Mode	Active Cooling
Adapter Power Supply	AC100 ~ 240V 50 / 60Hz	CRI	96+
TLCI	97+	App Control Type	BLE
Color Temperature	2700K ~ 6500K(±200K)	Remote Ability	≤100m
Radio Frequency	2.4GHz	Power Supply	AC
Size	11.43 × 5.7 × 5.7in	Weight	7.38 Pound

Photometrics

CCT / INT	Distance	1m	3m	5m
	llumination			
2700K	Bare Bulb	1227 fc	136 fc	51 fc
		13200 lux	1460 lux	546 lux
	Hyper-Reflector	7612 fc	610 fc	207 fc
		81900 lux	6560 lux	2230 lux
3200K	Bare Bulb	1589 fc	175 fc	65 fc
		17100 lux	1880 lux	700 lux
	Hyper-Reflector	9944 fc	794 fc	270 fc
		107000 lux	8540 lux	2900 lux
4800K (MAX lux)	Bare Bulb	1877 fc	206 fc	78 fc
		20200 lux	2220 lux	840 lux
	Hyper-Reflector	11803 fc	948 fc	322 fc
		127000 lux	10200 lux	3460 lux
5600K	Bare Bulb	1757 fc	195 fc	72 fc
		18900 lux	2100 lux	780 lux
	Hyper-Reflector	11245 fc	896 fc	303 fc
		121000 lux	9640 lux	3260 lux
6500K	Bare Bulb	1552 fc	172 fc	64 fc
		16700 lux	1850 lux	690 lux
	Hyper-Reflector	10037 fc	796 fc	270 fc
		108000 lux	8570 lux	2900 lux

* This is an averaged result, the number might be slightly different on each light.