

Panasonic[®]

Operating Instructions / Owner's Manual

<Complete Guide>

Digital Camera

Model No. **DC-GH7**

LUMIX

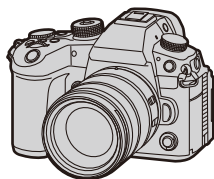

Please read these instructions carefully before using this product.

Register online at

<http://shop.panasonic.com/support/register>

(U.S. customers only)

DVQP3109ZA
F0624KN0

About Operating Instructions

This document, "Operating Instructions / Owner's Manual <Complete Guide>", includes detailed explanations of all the functions and operations of the camera.

❖ Symbols Used in This Document

Black icons show conditions in which functions can be used, and gray icons show conditions in which functions cannot be used.

Example:

Pictures/Videos  

Recording mode      

Operating symbols

In this document, camera operation is explained using the following symbols:

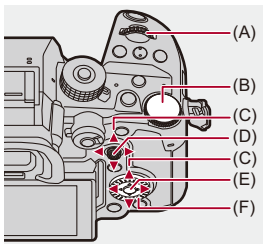

(A)  :

Front dial

(B)  :

Rear dial

(C)  :

Cursor button up/down/left/right

or

Joystick up/down/left/right

(D)  :

Press the center of the joystick

(E)  :

[MENU/SET] button

(F)  :

Control dial

- Other symbols, such as icons shown on the camera screen, are also used in explanations.
- This document describes the procedure for selecting menu items as follows:
Example) Set [Picture Quality] of the [Photo] ([Image Quality]) menu to [STD.].

 ⇒ [] ⇒ [] ⇒ [Picture Quality] ⇒ **Select [STD.]**

Notification classification symbols

In this document, notifications are classified and described using the following symbols:

 : To confirm prior to using the function

 : Hints for better use of the camera and tips for recording

 : Notifications and supplementary items regarding specifications

 : Related functions and information

- Images and illustrations used in this document are for explaining the functions.
- Description in this document is based on the interchangeable lens (H-ES12060).

Contents

About Operating Instructions 2

Introduction 19

Before Use	20
Standard Accessories	23
Lenses That Can Be Used	25
Memory Cards That Can Be Used	26
Names of Parts	29
Camera	29
Supplied Lens	37
Viewfinder/Monitor Displays	39

Getting Started 41

Attaching a Shoulder Strap	42
Charging the Battery	44
Charging with the Charger	46
Battery Insertion	50
Inserting a Battery into the Camera for Charging	52
Using the Camera While Supplying It with Power (Supplying Power/ Charging)	56
Notifications Regarding Charging/Power Supply	58
[Power Save Mode]	60
Inserting Cards (Optional)	63
Attaching a Lens	67
Attaching a Lens Hood	70
Adjusting the Monitor Direction and Angle	73
Setting the Clock (When Turning On for the First Time)	75

Basic Operations **79**

How to Hold the Camera	80
Selecting the Recording Mode.....	82
Camera Setting Operations	83
Monitor/Viewfinder Display Settings	90
Setting the Viewfinder	90
Switching Between the Monitor and Viewfinder	91
Switching the Display Information	94
Quick Menu.....	97
Control Panel.....	99
Menu Operation Methods	102
[Reset]	107
Entering Characters.....	108
Intelligent Auto Mode	109
Recording Using Touch Functions.....	115
Touch AF/Touch Shutter	115
Touch AE.....	118

Taking Pictures **120**

Basic Picture Operations	121
[Aspect Ratio]	124
[Picture Size].....	125
[Picture Quality]	127

Recording Videos **129**

Basic Video Operations	130
[System Frequency].....	138
[Rec. File Format]	140

[Rec Quality]	142
RAW Video Recording.....	159
Proxy Recording	161
[Image Area of Video].....	166

Focus / Zoom

168

Selecting the Focus Mode	169
Using AF	171
[AF-Point Scope]	176
[AF Custom Setting(Photo)]	178
[Focus Limiter]	181
[AF Assist Light]	183
[Focus Frame Moving Speed]	184
[AF Micro Adjustment]	185
Selecting the AF Mode	189
Automatic Detection	192
[Tracking].....	196
[Full Area AF]	197
[Zone(Horizontal/Vertical)]/[Zone].....	200
[1-Area+]/[1-Area].....	202
[Pinpoint]	204
AF Area Operations	206
Move the Position of the AF Area.....	206
Changing the Size of the AF Area.....	209
Resetting the AF Area	210
Focus on and Adjust Brightness for the Touched Position ([AF+AE]).....	211
Moving the AF Area Position with the Touch Pad	212
[Focus Switching for Vert / Hor].....	214
Record Using MF	215

[Focus Peaking].....	220
Recording with Zoom.....	222
[Crop Zoom(Photo)].....	224
[Crop Zoom(Video)].....	228
[Power Zoom Lens].....	232
Drive / Shutter / Image Stabilizer	233
Selecting the Drive Mode.....	234
Taking Burst Pictures.....	236
High Resolution mode	247
Recording with Time Lapse Shot.....	252
Recording with Stop Motion Animation.....	259
Time Lapse Shot/Stop Motion Animation Videos	263
Recording Using the Self-timer.....	265
Bracket Recording	269
[Live View Composite]	277
[Silent Mode].....	281
[Shutter Type]	283
[Long Exposure NR].....	287
[Synchro Scan(Photo)]	288
[Min. Shutter Speed].....	290
[Shutter Delay].....	291
Image Stabilizer	292
Image Stabilizer Settings.....	295
Metering / Exposure / ISO Sensitivity	302
[Metering Mode].....	303
Program AE Mode	305
Program Shift	307

Aperture-Priority AE Mode.....	309
Shutter-Priority AE Mode	312
Manual Exposure Mode.....	315
Available Shutter Speeds (Sec.)	318
[B] (Bulb)	319
Preview Mode	320
Exposure Compensation	322
[i.Dynamic Range].....	325
Locking Focus and Exposure (AF/AE Lock).....	326
ISO Sensitivity	328
[ISO Sensitivity (photo)].....	332
White Balance / Image Quality	333
White Balance (WB)	334
Adjusting the White Balance	340
[Photo Style]	342
[Filter Settings].....	356
[Simultaneous Record w/o Filter].....	361
[REAL TIME LUT]	362
[LUT Library]	364
Base Photo Style of LUT files.....	368
Lens Compensation.....	370
[Vignetting Comp.].....	370
[Diffraction Compensation]	371
Flash	372
Using an External Flash (Optional).....	373
Removing the Hot Shoe Cover.....	374
Setting Flash.....	377

[Flash Mode].....	378
[Firing Mode]/[Manual Flash Adjust.].....	381
[Flash Adjust.].....	383
[Flash Synchro]	384
[Auto Exposure Comp.]	385
Recording Using a Wireless Flash.....	386

Video Settings

393

Recording Modes Specifically for Video (Creative Video)	394
Displays Suited to Video Recording	395
Setting the Exposure for Recording Videos.....	396
Separating Settings for Recording Video and Pictures	400
Using AF (Video)	402
[Continuous AF].....	402
[AF Custom Setting(Video)].....	404
[Enlarged Live Display(Video)]	405
Video Brightness and Coloring	407
[Luminance Level]	407
[Master Pedestal Level].....	409
Recording While Controlling Overexposure (Knee).....	410
[ISO Sensitivity (video)]	412
Audio Settings.....	413
[Sound Rec Level Disp.].....	414
[Mute Sound Input]	415
[Sound Rec Gain Level]	416
[Sound Rec Level Adj.].....	417
[Sound Rec Quality]	418
[Sound Rec Level Limiter]	420
[Wind Noise Canceller].....	421
[Lens Noise Cut].....	422
[Audio Information]	423

External Microphones (Optional)	424
Setting the Sound Pickup Range (DMW-MS2: Optional)	427
Reduction of Wind Noise	428
XLR Microphone Adaptor (Optional).....	429
[4ch Audio Recording]	432
Headphones	433
[Sound Monitoring Channel].....	435
Time Code	437
Setting the Time Code.....	438
Synchronizing the Time Code with an External Device	440
Preparations for Time Code Synchronization.....	441
Synchronize the Time Code of the External Device with That of the Camera (TC OUT).....	443
Synchronize the Time Code of the Camera with That of the External Device (TC IN).....	445
Main Assist Functions.....	448
[Flicker Decrease (Video)].....	449
[SS/Gain Operation]	450
[WFM/Vector Scope]	452
[Luminance Spot Meter]	456
[Zebra Pattern]	458
[Frame Marker].....	460
Color Bars/Test Tone	462

Special Video Recording **464**

Variable Frame Rate.....	465
High Frame Rate Video	470
[Focus Transition]	473
[Live Cropping].....	478
Log Recording	483

[Log View Assist]	490
HLG Videos	492
[HLG View Assist].....	495
Anamorphic Recording	496
[Anamorphic Desqueeze Display]	498
[Synchro Scan(Video)].....	500
[Loop Recording (video)]	502
[Segmented File Recording]	505
List of Recording Qualities That Enable Special Videos to be Recorded	506

HDMI Output (Video) 517

Connecting HDMI Devices.....	518
HDMI Output Image Quality.....	519
Images Output via HDMI	519
Settings for Down-Converting.....	522
HDMI Output Settings.....	527
Outputting the Camera Information Display via HDMI.....	528
Outputting Control Information to an External Recorder	529
Outputting Audio via HDMI	529
Outputting the Enlarged Live Display (Video) via HDMI	530
Outputting as 4K/120p (4K/100p) via HDMI	531
[4K/120p Power Save Live View]	
([4K/100p Power Save Live View]).....	532
Output of RAW Video Data.....	533
Outputting RAW Video Data via HDMI.....	535
Notes When Outputting RAW Video Data	540

Using an External SSD (Commercially Available) 541

Compatible External SSDs	542
--------------------------------	-----

Connecting the External SSD	543
Formatting the External SSD	546
Notes About External SSDs.....	547

Playing Back and Editing of Images 549

Playing Back Pictures	550
Playing Back Videos	552
Video Repeat Playback	556
Extracting a Picture	558
[Video Divide]	559
Switching the Display Mode.....	561
Enlarged Display	562
Thumbnail Screen	564
Calendar Playback	566
Group Images	567
Deleting Images.....	569
[RAW Processing].....	571
[Video Repair]	580
[Playback] Menu	583
How to Select an Image(s) in the [Playback] Menu.....	583
[Playback] ([Playback Mode]).....	585
[Playback] ([Process Image]).....	588
[Playback] ([Add/Delete Info.].....	589
[Playback] ([Edit Image])	590
[Playback] ([Others]).....	595

Camera Customization 596

Fn Buttons	597
Register Functions to the Fn Buttons	600
Use the Fn Buttons.....	611

[Dial Operation Switch]	612
Register Functions to the Dials.....	612
Temporarily Change Dial Operation.....	614
Quick Menu Customization.....	615
Register to the Quick Menu.....	615
Custom Mode	622
Register in Custom Mode.....	623
Using Custom Mode.....	625
Calling Up Settings.....	626
[Custom] Menu	627
[Custom] menu ([Image Quality]).....	628
[Custom] menu ([Focus/Shutter])	634
[Custom] menu ([Operation]).....	640
[Custom] menu ([Monitor / Display (Photo)])	647
[Custom] menu ([Monitor / Display (Video)])	658
[Custom] menu ([IN/OUT]).....	662
[Custom] menu ([Lens / Others]).....	664
[Setup] Menu	668
[Setup] menu ([Card/File]).....	669
[Setup] menu ([Monitor / Display]).....	678
[Setup] menu ([IN/OUT])	683
[Setup] menu ([Setting])	690
[Setup] menu ([Others]).....	693
My Menu	698
Registration in My Menu.....	698
Edit My Menu	699

List of Menu

700

[Photo] menu	701
[Video] menu.....	703

[Custom] menu	706
[Setup] menu	710
[My Menu]	713
[Playback] menu	714

Wi-Fi / Bluetooth

715

Connecting to “LUMIX Lab”	717
Installing “LUMIX Lab”	718
Connecting to a Smartphone (Bluetooth Connection).....	719
Using “LUMIX Lab”	723
LUT Library Operations	723
Import images.....	725
[Auto Transfer].....	727
[Location Logging].....	730
Connecting to “LUMIX Sync”	732
Installing “LUMIX Sync”	733
Connecting to a Smartphone (Bluetooth Connection).....	734
Connecting to a Smartphone ([Wi-Fi connection]).....	741
Sending Images on the Camera to a Smartphone with Simple Operations	747
Using “LUMIX Sync”	750
[Remote shooting]	752
[Shutter Remote Control].....	754
[Import images].....	757
[Auto Transfer].....	759
[Location Logging]	762
[Remote Wakeup].....	764
[Auto Clock Set].....	766
[Camera settings copy].....	767
Sending Images from the Camera to a PC.....	768

Wi-Fi Connections	772
[Via Network]	773
[Direct]	777
Connect to Wi-Fi Using Previously Saved Settings.....	779
Fn Button Assigned with [Wi-Fi]	781
Send Settings and Selecting Images.....	782
Image Send Settings	782
Selecting Images.....	783
[LAN / Wi-Fi Setup] Menu	784
Frame.io Camera to Cloud	787
Connecting with Frame.io	788
[Send Images to Frame.io]	793
[Upload Setup]	794
Streaming Function	796
Stream by Operating a Smartphone	798
Stream by Operating the Camera.....	802
Stream by Operating the PC.....	807
Streaming Settings	810
Notes When Using the Streaming Function.....	818
Notes When Using USB Tethering/Wired LAN.....	819
Connecting to Other Devices	820
Connecting.....	821
Viewing on a TV.....	823
Importing Images to a PC	827
Copying Images to a PC	828
Installing Software	831

Storing on a Recorder.....	832
Tethered Recording.....	833
Installing Software.....	834
Operating the Camera from a PC.....	835
Using "LUMIX Tether" with a Wired LAN Connection.....	836
Remote Control of Multiple Cameras.....	838

Materials **841**

Digital Camera Accessory System.....	842
Using Optional Accessories.....	844
Shutter Remote Control (Optional).....	845
Tripod Grip (Optional).....	847
DC Coupler (Optional).....	848
Monitor/Viewfinder Displays.....	849
Recording Screen.....	849
Playback Screen.....	866
Message Displays.....	871
Troubleshooting.....	875
Power, Battery.....	876
Recording.....	877
Video.....	882
Playback.....	883
Monitor/Viewfinder.....	884
Flash.....	884
Wi-Fi Function.....	885
TV, PC.....	888
Others.....	889
Cautions for Use.....	890
Number of Pictures That Can Be Taken and Available Recording Time with the Battery.....	903

Number of Pictures That Can Be Taken and Video Recording Time According to Recording Media.....	907
List of Default Settings/Custom Saving/Settings Available for Copying.....	919
List of Functions That Can Be Set in Each Recording Mode...	947
Specifications.....	955
Trademarks and Licenses	973

Introduction

This chapter describes information you should know before starting.

- [Before Use: 20](#)
- [Standard Accessories: 23](#)
- [Lenses That Can Be Used: 25](#)
- [Memory Cards That Can Be Used: 26](#)
- [Names of Parts: 29](#)

Before Use

❖ Firmware of Your Camera/Lens

Firmware updates may be provided in order to improve camera capabilities or to add functionality.

Make sure that the firmware of the camera/lens you purchased is the latest version.

We recommend using the latest firmware version.

- To check the firmware version of the camera/lens, attach the lens to the camera and select [Firmware Version] in the [Setup] ([Others]) menu. You can also update the firmware in [Firmware Version]. (→[Firmware Version]: 696)
- **For the latest information on the firmware or to download/update the firmware, visit the following support site:**

<https://panasonic.jp/support/global/cs/dsc/download/index.html>

(English only)

❖ Handling of the Camera

When using the camera, take care not to drop it, bump it, or apply undue force. These may cause malfunction or damage to the camera and lens.

If sand, dust, or liquid gets on the monitor, wipe it off with a dry soft cloth.

- Touch operations may be incorrectly recognized.

When using in low temperatures (–10 °C to 0 °C (14 °F to 32 °F))

- Before use, attach a Panasonic lens with a minimum recommended operating temperature of –10 °C (14 °F).

Do not place a hand inside the camera mount.

This may cause a failure or damage because the sensor is a precision device.

If you shake the camera while turning the camera off, a sensor may operate or a rattling sound may be heard. This is caused by the image stabilizer mechanism in the body. It is not a malfunction.

❖ **Splash Resistant**

Splash Resistant is a term used to describe an extra level of protection this camera offers against exposure to a minimal amount of moisture, water or dust. Splash Resistant does not guarantee that damage will not occur if this camera is subjected to direct contact with water.

In order to minimize the possibility of damage please be sure the following precautions are taken:

- Splash Resistant works in conjunction with the lenses that were specifically designed to support this feature.
- Securely close the doors, socket caps, etc.
- When the lens or cap is removed or a door is open, do not allow sand, dust, and moisture to enter inside.
- If liquid gets on the camera, wipe it off with a dry soft cloth.

❖ **Condensation (When the Lens, the Viewfinder or Monitor is Fogged Up)**

- Condensation occurs when there are temperature or humidity differences. Take care as this may lead to soiling, mold, and malfunctions in the lens, viewfinder, and monitor.
- If condensation occurs, turn off the camera and leave it for approx. 2 hours. The fog will disappear naturally when the temperature of the camera becomes close to the ambient temperature.

❖ **Be Sure to Perform Trial Recording in Advance**

Perform trial recording in advance of an important event (wedding, etc.) to check that recording can be performed normally.

❖ **No Compensation Regarding Recording**

Please note that compensation cannot be provided in the event that recording could not be performed due to a problem with the camera or a card.

❖ **Be Careful with Regard to Copyrights**

Under copyright law, you may not use the images and audio you have recorded for other than personal enjoyment without the permission of the copyright holder. Be careful because there are cases where restrictions apply to recording even for the purpose of personal enjoyment.

❖ **Also Read “[Cautions for Use](#)” (→ [Cautions for Use: 890](#))**

Standard Accessories

Check that all the accessories are supplied before using the camera.

- The accessories and their shape will differ depending on the country or area where the camera was purchased.

For details on the accessories, refer to “Operating Instructions / Owner’s Manual <Quick Start Guide>” (supplied).

- **Digital camera body**

(This is referred to as **camera** in this document.)

- **Battery pack**

(This is referred to as **battery pack** or **battery** in this document.)

- Charge the battery before use.

- **Battery charger**

(This is referred to as **battery charger** or **charger** in this document.)

- **BNC conversion cable (for TC IN/OUT)**

- **Shoulder strap**

- **Body cap^{*1}**

- **Eye cup^{*1}**

- **Hot shoe cover^{*1}**

- **Flash synchro socket cap^{*1}**

*1 This is attached to the camera at the time of purchase.

Items Supplied with DC-GH7L (Lens Kit Product)

- **Interchangeable lens:**

H-ES12060 “LEICA DG VARIO-ELMARIT 12-60mm/F2.8-4.0 ASPH./POWER O.I.S.”

- Dust and splash resistant
- The recommended operating temperature is from -10 °C to 40 °C (14 °F to 104 °F)

- **Lens hood**

- **Lens cap^{*2}**

- **Lens rear cap^{*2}**

Items Supplied with DC-GH7M (Lens Kit Product)

- **Interchangeable lens:**

H-FS12060 “LUMIX G VARIO 12-60mm/F3.5-5.6 ASPH./POWER O.I.S.”

- Dust and splash resistant
- The recommended operating temperature is from 0 °C to 40 °C (32 °F to 104 °F)

- **Lens hood**

- **Lens cap^{*2}**

- **Lens rear cap^{*2}**

*2 This is attached to the lens at the time of purchase.

- **The memory card is optional.**

- Consult the dealer or Panasonic if you lose the supplied accessories. (You can purchase the accessories separately.)

Lenses That Can Be Used

The camera can use the dedicated lenses that comply with the Micro Four Thirds™ system lens mount specification (Micro Four Thirds mount).



❖ About the Lens and Functions

Depending on the lens used, certain functions, such as focus, image stabilizer, and zoom functions, may be disabled or operate differently.

- Refer to catalogs/websites for information regarding supported lenses.
<https://panasonic.jp/support/global/cs/dsc/connect/index.html>
(English only)



- The focal lengths marked on a Micro Four Thirds lens are equivalent to twice those of a 35 mm film camera.
(The focal lengths will be equivalent to those of a 100 mm lens in 35 mm terms when a 50 mm lens is used.)

Memory Cards That Can Be Used

You can use CFexpress cards and SD memory cards with this camera. The memory cards that can be used are described below (As of May 2024).

- SD memory card, SDHC memory card, and SDXC memory card are referred to by the generic name of **SD card** in this document.
- When not differentiating between a CFexpress card and SD card, a card is referred to as simply **card**.
- **For information on memory cards with confirmed operation, check the following support site:**
<https://panasonic.jp/support/global/cs/dsc/connect/index.html>
(English only)

Card slot 1: CFexpress card

CFexpress card (CFexpress Ver.2.0 Type B) (64 GB to 2 TB)

Card slot 2: SD memory card

SD memory card/SDHC memory card/SDXC memory card (Maximum 512 GB)

- The camera supports UHS-I/UHS-II UHS Speed Class 3 standard and UHS-II Video Speed Class 90 standard SD cards.







❖ SD Cards That Can Be Used with This Camera

When using the following functions, use cards that have the correct SD Speed Class, UHS Speed Class, and Video Speed Class.

- Speed classes are standards to guarantee the minimum speed necessary for continuous writing.

[Video Record]

Bit rate of the recording quality	Speed Class	Example of indication
72 Mbps or less	Class 10	CLASS  
	UHS Speed Class 1 or higher	
	Video Speed Class 10 or higher	V10
200 Mbps or less	UHS Speed Class 3	
	Video Speed Class 30 or higher	V30
400 Mbps or less	Video Speed Class 60 or higher	V60
600 Mbps or less	Video Speed Class 90	V90

- The following types of video cannot be recorded to SD cards. Use CFexpress cards.
 - [MOV] video with bit rate of 800 Mbps or more
 - [Apple ProRes] video with resolution other than FHD
 - Variable frame rate video with a recording quality with image compression mode ALL-Intra



- You can prevent the writing and deleting of data by setting the write-protect switch (A) on the SD card to “LOCK”.

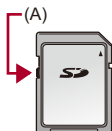

- The data stored on a card may be damaged due to electromagnetic waves, static electricity or a failure of the camera or card. We recommend backing up important data.
- Keep the memory card out of reach of children to prevent swallowing.

Names of Parts

- Camera: 29
- Supplied Lens: 37
- Viewfinder/Monitor Displays: 39

Camera

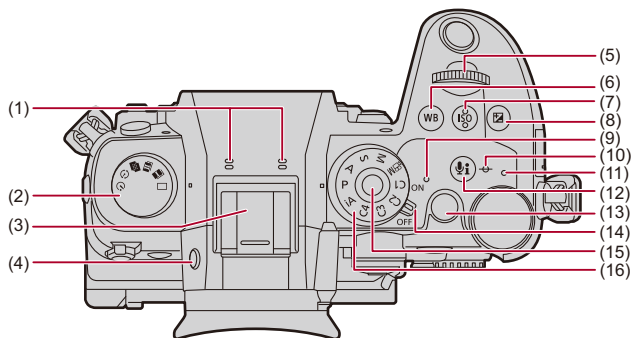

- (1) Stereo microphone (→ [Audio Settings: 413](#))
 - Do not block the microphone with a finger. Audio will be difficult to record.
- (2) Drive mode dial (→ [Selecting the Drive Mode: 234](#))
- (3) Hot shoe (hot shoe cover) (→ [Removing the Hot Shoe Cover: 374](#))
 - Keep the hot shoe cover out of reach of children to prevent swallowing.
- (4) [LVF] button (→ [Switching Between the Monitor and Viewfinder: 91](#))
- (5) Front dial (→ [Front Dial/Rear Dial: 84](#))
- (6) [WB] (White balance) button (→ [White Balance \(WB\): 334](#))
- (7) [ISO] (ISO sensitivity) button (→ [ISO Sensitivity: 328](#))
- (8) [] (Exposure compensation) button (→ [Exposure Compensation: 322](#))
- (9) Power indicator (→ [Setting the Clock \(When Turning On for the First Time\): 75](#))
- (10) [] (Recording distance reference mark) (→ [Operations on the MF Assist Screen: 217](#))
- (11) Charging light (→ [Charging Light Indications: 54](#))/
Network connection light (→ [Checking operation of the Wi-Fi and Bluetooth functions: 715](#))
- (12) [] (Audio information) button (→ [\[Audio Information\]: 423](#))
- (13) Video rec. button (→ [Basic Video Operations: 130](#))
- (14) Camera on/off switch (→ [Setting the Clock \(When Turning On for the First Time\): 75](#))
- (15) Mode dial lock button (→ [Selecting the Recording Mode: 82](#))
- (16) Mode dial (→ [Selecting the Recording Mode: 82](#))

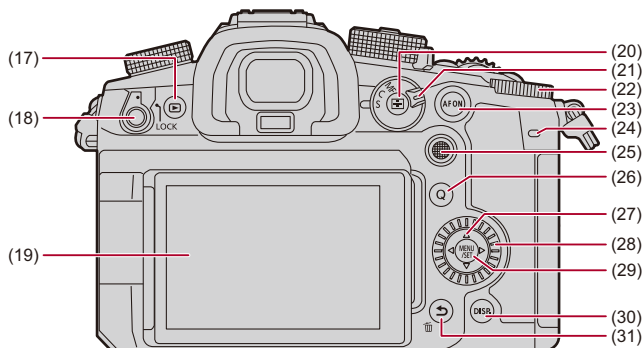

- (17) [▶] (Playback) button (→ [Playing Back and Editing of Images: 549](#))
- (18) Operation lock lever (→ [Operation Lock Lever: 89](#))
- (19) Monitor (→ [Viewfinder/Monitor Displays: 39](#), [Monitor/Viewfinder Displays: 849](#))/
Touch screen (→ [Touch Screen: 87](#))
- (20) [■] (AF mode) button (→ [Selecting the AF Mode: 189](#))
- (21) Focus mode lever (→ [Selecting the Focus Mode: 169](#), [Using AF: 171](#), [Record Using MF: 215](#))
- (22) Rear dial (→ [Front Dial/Rear Dial: 84](#))
- (23) [AF ON] button (→ [\[AF ON\] button: 173](#))
- (24) Rear tally lamp (→ [Basic Video Operations: 130](#))
- (25) Joystick (→ [Joystick: 86](#))/
Fn buttons (→ [Fn Buttons: 597](#))
Center: Fn9, ▲: Fn10, ►: Fn11, ▼: Fn12, ◀: Fn13

- (26) [Q] (Quick menu) button (→ [Quick Menu: 97](#))
- (27) Cursor buttons (→ [Cursor Buttons: 85](#))/
Fn buttons (→ [Fn Buttons: 597](#))
▲: Fn14, ►: Fn15, ▼: Fn16, ◀: Fn17
- (28) Control dial (→ [Control Dial: 84](#))
- (29) [MENU/SET] button (→ [\[MENU/SET\] Button: 85](#), [Menu Operation Methods: 102](#))
- (30) [DISP.] button (→ [Switching the Display Information: 94](#))
- (31) [↵] (Cancel) button (→ [Menu Operation Methods: 102](#))/
[🗑️] (Delete) button (→ [Deleting Images: 569](#))/
Fn button (Fn1) (→ [Fn Buttons: 597](#))

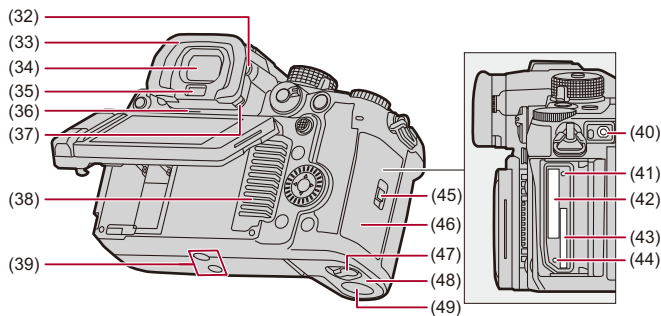

- (32) Diopter adjustment dial (→ [Adjusting the Viewfinder Diopter: 90](#))
- (33) Eye cup (→ [Cleaning the Viewfinder: 894](#))
- Keep the eye cup out of reach of children to prevent swallowing.
- (34) Viewfinder (→ [Viewfinder/Monitor Displays: 39](#), [Switching Between the Monitor and Viewfinder: 91](#), [Monitor/Viewfinder Displays: 849](#))
- (35) Eye sensor (→ [Switching Between the Monitor and Viewfinder: 91](#))
- (36) Speaker (→ [\[Beep\]: 683](#))
- (37) Eye cup lock lever (→ [Cleaning the Viewfinder: 894](#))
- (38) Fan inlet (→ [\[Fan Mode\]: 663](#))
- The fan inlet for the cooling fan.
 - Do not obstruct this unit's ventilation openings with newspapers, tablecloths, curtains, and similar items.
- (39) Tripod mount (→ [Tripod: 901](#))
- If you attempt to attach a tripod with a screw length of 5.5 mm (0.22 inch) or more, you may not be able to securely fix it in place or it may damage the camera.

- (40) [REMOTE] socket (→ [Shutter Remote Control \(Optional\): 845](#))
- (41) Card access light 1 (→ [Card Access Indications: 65](#))
- (42) Card slot 1 (→ [Inserting Cards \(Optional\): 63](#))
- (43) Card slot 2 (→ [Inserting Cards \(Optional\): 63](#))
- (44) Card access light 2 (→ [Card Access Indications: 65](#))
- (45) Card door lock lever (→ [Inserting Cards \(Optional\): 63](#))
- (46) Card door (→ [Inserting Cards \(Optional\): 63](#))
- (47) Battery door release lever (→ [Battery Insertion: 50](#))
- (48) Battery door (→ [Battery Insertion: 50](#))
- (49) DC Coupler cover (→ [DC Coupler \(Optional\): 848](#))

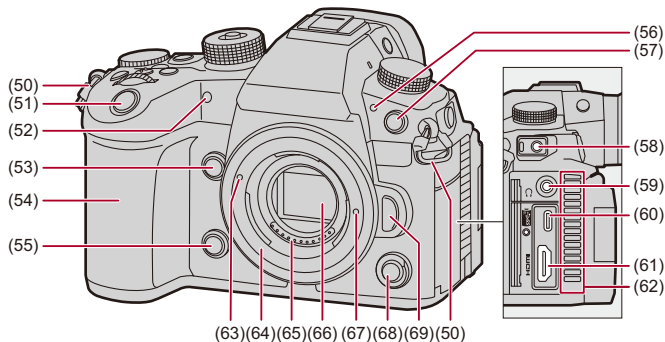

- (50) Shoulder strap eyelet (→ [Attaching a Shoulder Strap: 42](#))
- (51) Shutter button (→ [Basic Picture Operations: 121](#))
- (52) Self-timer light (→ [Recording Using the Self-timer: 265](#))/
AF assist light (→ [\[AF Assist Light\]: 183](#))
- (53) Enlarged live display (video) button (→ [\[Enlarged Live Display\(Video\)\]: 405](#))/
Fn button (Fn2) (→ [Fn Buttons: 597](#))
- (54) Grip
- (55) Preview button (→ [Preview Mode: 320](#))/
Fn button (Fn3) (→ [Fn Buttons: 597](#))
- (56) Front tally lamp (→ [Basic Video Operations: 130](#))
- (57) Flash synchro socket (flash synchro socket cap) (→ [Connecting a Synchro Cable to the Flash Synchro Socket: 375](#))
- Use the flash with a synchronization voltage of 250 V or less.
 - Connect the supplied BNC conversion cable (for TC IN/OUT) when synchronizing the time code with an external device. (→ [Synchronizing the Time Code with an External Device: 440](#))
 - Keep the flash synchro socket cap out of reach of children to prevent swallowing.

- (58) [MIC] socket (→[External Microphones \(Optional\): 424](#))
- (59) Headphone socket (→[Headphones: 433](#))
 - Excessive sound pressure from earphones and headphones can cause hearing loss.
- (60) USB port (→[Inserting a Battery into the Camera for Charging: 52](#), [Connecting the External SSD: 543](#), [Streaming Function: 796](#), [USB port: 822](#), [Using "LUMIX Tether" with a Wired LAN Connection: 836](#))
- (61) HDMI socket (→[Connecting HDMI Devices: 518](#), [Output of RAW Video Data: 533](#), [HDMI socket: 821](#))
- (62) Fan outlet (→[\[Fan Mode\]: 663](#))
 - The fan outlet for the cooling fan.
 - Do not obstruct this unit's ventilation openings with newspapers, tablecloths, curtains, and similar items.
- (63) Lens fitting mark (→[Attaching a Lens: 67](#))
- (64) Mount
- (65) Contact points
- (66) Sensor
- (67) Lens lock pin
- (68) Sub video rec. button (→[Basic Video Operations: 130](#))
- (69) Lens release button (→[Removing a Lens: 69](#))

Supplied Lens

H-ES12060

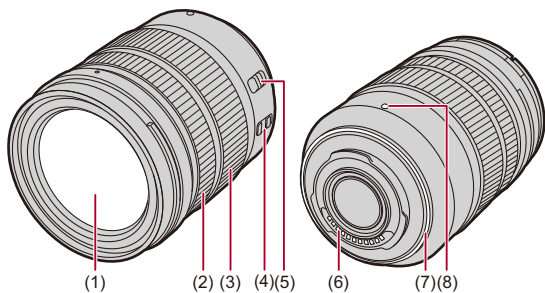

H-FS12060

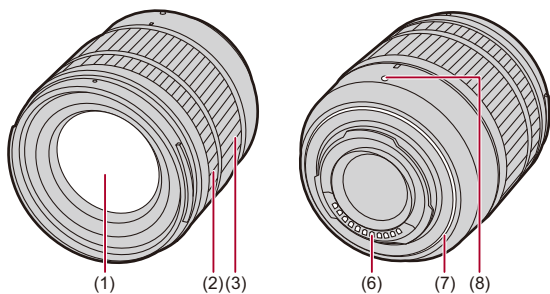

- (1) Lens surface
- (2) Focus ring (→ [Record Using MF: 215](#))
- (3) Zoom ring (→ [Recording with Zoom: 222](#))
- (4) O.I.S. switch (→ [Image Stabilizer: 292](#))
- (5) [AF/MF] switch (→ [Using AF: 171](#), [Record Using MF: 215](#))
 - You can switch between AF and MF.
If [MF] is set on either the lens or camera, operation will be with MF.
- (6) Contact points
- (7) Lens mount rubber
- (8) Lens fitting mark (→ [Attaching a Lens: 67](#))

Viewfinder/Monitor Displays

At the time of purchase, the viewfinder/monitor displays the following icons.

- For information about the icons other than those described here (→ [Monitor/Viewfinder Displays: 849](#))

Viewfinder

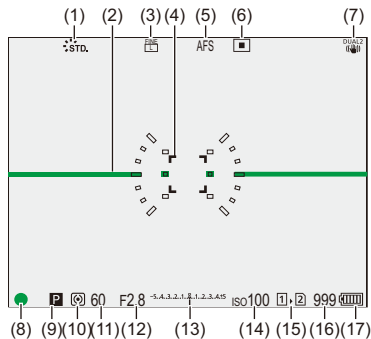

Monitor

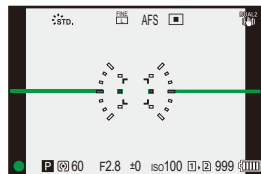

- (1) Photo Style (→[Photo Style]: 342)
- (2) Level gauge (→[Level Gauge]: 656)
- (3) Picture quality (→[Picture Quality]: 127)/
Picture size (→[Picture Size]: 125)
- (4) AF area (→AF Area Operations: 206)
- (5) Focus mode (→Selecting the Focus Mode: 169, Using AF: 171, Record Using MF: 215)
- (6) AF mode (→Selecting the AF Mode: 189)
- (7) Image stabilizer (→Image Stabilizer: 292)
- (8) Focus (green) (→Basic Picture Operations: 121, Using AF: 171)/
Recording state (red) (→Basic Video Operations: 130, High Resolution mode: 247)
- (9) Recording mode (→Selecting the Recording Mode: 82)
- (10) Metering mode (→[Metering Mode]: 303)
- (11) Shutter speed (→Basic Picture Operations: 121, Shutter-Priority AE Mode: 312)
- (12) Aperture value (→Basic Picture Operations: 121, Aperture-Priority AE Mode: 309)
- (13) Exposure compensation value (→Exposure Compensation: 322)/
Manual Exposure Assist (→Manual Exposure Assist: 317)
- (14) ISO sensitivity (→ISO Sensitivity: 328)
- (15) Card slot (→Inserting Cards (Optional): 63)/
Double card slot function (→[Double Card Slot Function]: 670)
- (16) Number of pictures that can be taken (→Number of Pictures That Can Be Taken and Video Recording Time According to Recording Media: 907)/
Number of pictures that can be taken continuously (→Number of Pictures That Can Be Taken Continuously: 242)
- (17) Battery indication (→Power Indications: 58)



- Press [>] to switch between display/hide of the level gauge.

Getting Started

Before recording, read this chapter to prepare the camera.

- [Attaching a Shoulder Strap: 42](#)
- [Charging the Battery: 44](#)
- [Inserting Cards \(Optional\): 63](#)
- [Attaching a Lens: 67](#)
- [Adjusting the Monitor Direction and Angle: 73](#)
- [Setting the Clock \(When Turning On for the First Time\): 75](#)

Attaching a Shoulder Strap

Attach a shoulder strap to the camera with the following procedure to prevent it from dropping.

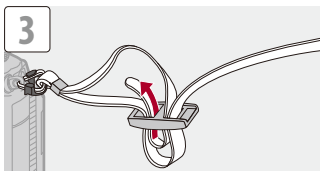
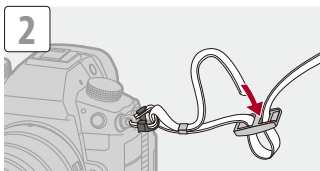
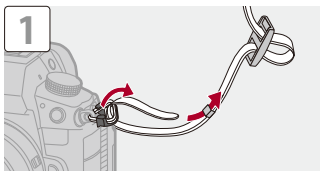

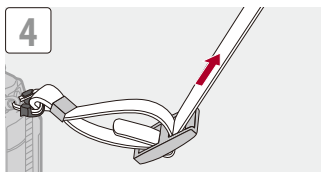

- Pull the shoulder strap and check that it will not come out.
- Attach the opposite end of the shoulder strap with the same procedure.
- Use the shoulder strap around your shoulder.
 - Do not wrap the strap around your neck.
It may result in injury or accident.
- Do not leave the shoulder strap where an infant can reach it.
 - It may result in an accident by mistakenly wrapping around the neck.

Charging the Battery

- [Charging with the Charger: 46](#)
- [Battery Insertion: 50](#)
- [Inserting a Battery into the Camera for Charging: 52](#)
- [Using the Camera While Supplying It with Power \(Supplying Power/Charging\): 56](#)
- [Notifications Regarding Charging/Power Supply: 58](#)
- [\[Power Save Mode\]: 60](#)

You can charge the battery either using the supplied charger, or in the camera body.

You can also turn on the camera and supply power from an electrical outlet.

You can also use the Battery Charger (DMW-BTC15: optional).

- The battery that can be used with the camera is DMW-BLK22. (As of May 2024)

Optional battery DMW-BLF19

You can also use DMW-BLF19 (optional), but there are the following limitations:

- The following functions cannot be used:
 - [Rec Quality] exceeding a resolution of C4K
 - [Rec Quality] with a high frame rate video exceeding a recording frame rate of 60.00p
 - [Variable Frame Rate] exceeding a frame rate of 60 fps
 - [HDMI RAW Data Output]
 - External SSD
 - [Streaming]
- The battery capacity is low, so this reduces the number of pictures that can be taken and the available recording time.
- There will be 4 remaining battery charge indicators.

We recommend using DMW-BLK22 (supplied/optional).



- The battery is not charged at the time of purchase. Charge the battery before use.

Charging with the Charger



- **It is recommended to use the Panasonic AC Adaptor (DMW-AC11: optional) for charging.**
- You can charge with the camera body or the supplied charger using a commercially available AC adaptor and a USB connection cable.
 - *Recommended specifications for the commercially available AC adaptor
 - Supports PD (Power Delivery)
 - Supports 9 V/3 A (27 W) DC output
 - USB Type-C terminal
 - *Use a USB connection cable with 27 W output or better for charging.
- You can also use an AC adaptor with 5 V/500 mA or better for charging. However, charging time may be longer than with the recommended AC adaptor.
- Operation is not guaranteed with all commercially available devices.

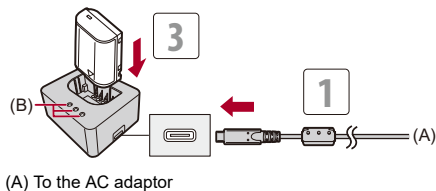

1 Connect the charger and the AC adaptor with the USB connection cable.

- Check the direction of the terminals and plug in/out straight holding onto the plug.

(Inserting these at an angle may cause deformation or malfunction)

2 Connect the AC adaptor to an electrical outlet.

3 Insert the battery.

- The charging lights ([CHARGE]) (B) blink and charging begins.

❖ Charging Lights Indications

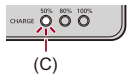
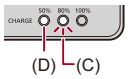
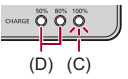
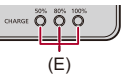
Charging status	0 % to 49 %	50 % to 79 %	80 % to 99 %	100 %
Charging lights	 <p>(C)</p>	 <p>(D) (C)</p>	 <p>(D) (C)</p>	 <p>(E)</p>

(C) Blinking

(D) On

(E) Off

- When the battery is inserted while the charger is not connected to the power source, the charging lights turn on for a certain period to allow you to confirm the battery level.

Charging time: Approx. 175 min

- Using the optional AC Adaptor (DMW-AC11) or the supplied accessories of the optional Battery Charger (DMW-BTC15).
- The indicated charging time is for when the battery has been discharged completely. The charging time may vary depending on how the battery has been used. The charging time for the battery in hot/cold environments or a battery that has not been used for a long time may be longer than normal.



- Use the charger indoors.



- After charging, disconnect the power source connection and remove the battery.
- If the [50%] light is blinking quickly, then charging is not occurring.
 - The temperature of the battery or surroundings is either too high or too low.
Try charging at an ambient temperature between 10 °C and 30 °C (50 °F and 86 °F).
 - The terminals of the charger or the battery are dirty.
Remove the connection to the power source, and wipe with a dry cloth.

Battery Insertion

- Always use genuine Panasonic batteries (DMW-BLK22).
- If you use other batteries, we cannot guarantee the quality of this product.



- Check that the camera on/off switch is set to [OFF].

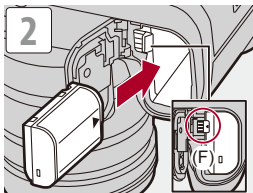
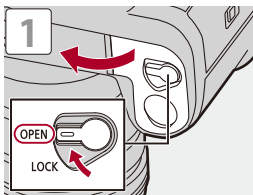

- Check that the lever (F) is holding the battery in place.

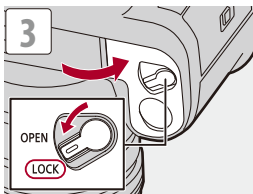

❖ Removing the Battery

- 1 Set the camera on/off switch to [OFF].
- 2 Open the battery door.
- 3 Push the lever (F) in the direction of the arrow and then remove the battery.
 - Check that the card access lights are off before removing the battery. (→ [Card Access Indications: 65](#))

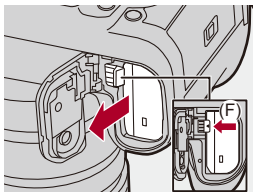

- Ensure that no foreign objects are adhering to the inner side (cushion) of the battery door.
- Remove the battery after use.
(The battery will drain if left inserted in the camera for a long period of time.)
- The battery becomes warm after use, during charging, and immediately after charging.
The camera also becomes warm during use. This is not a malfunction.
- Be careful when removing the battery as the battery will jump out.

Inserting a Battery into the Camera for Charging



- It is recommended to use the **Panasonic AC Adaptor (DMW-AC11: optional)** or the supplied accessories of the **Panasonic Battery Charger (DMW-BTC15: optional)** for charging.
- You can charge with the camera body or the supplied charger using a commercially available AC adaptor and a USB connection cable.
 - *Recommended specifications for the commercially available AC adaptor
 - Supports PD (Power Delivery)
 - Supports 9 V/3 A (27 W) DC output
 - USB Type-C terminal
 - *Use a USB connection cable with 27 W output or better for charging.
- You can also use an AC adaptor with 5 V/500 mA or better for charging. However, charging time may be longer than with the recommended AC adaptor.
- Operation is not guaranteed with all commercially available devices.

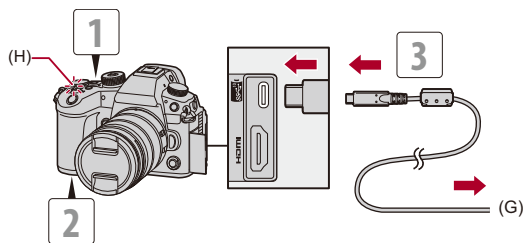

(G) To the AC adaptor

- 1 Set the camera on/off switch to [OFF].**
- 2 Insert the battery into the camera.**
- 3 Connect the camera USB port and the AC adaptor using the USB connection cable.**
 - Check the direction of the terminals and plug in/out straight holding onto the plug.
(Inserting these at an angle may cause deformation or malfunction.)
- 4 Connect the AC adaptor to an electrical outlet.**
 - The charging light (H) turns red and charging begins.

❖ Charging Light Indications

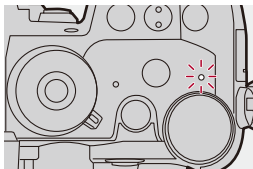

Charging light (red)

On: Charging.

Off: Charging has completed.

Blinking: Charging error.

Charging time: Approx. 170 min

- Using either the camera body and the optional AC Adaptor (DMW-AC11) or the camera body and the supplied accessories of the optional Battery Charger (DMW-BTC15).
- The indicated charging time is for when the battery has been discharged completely. The charging time may vary depending on how the battery has been used. The charging time for the battery in hot/cold environments or a battery that has not been used for a long time may be longer than normal.



- You can also charge the battery by connecting a USB device (PC, etc.) and the camera with the USB connection cable.

In that case, charging may take a while.



- After charging, disconnect the connection to the power source.
- While the charging light is blinking red, charging is not possible.
 - The temperature of the battery or surroundings is either too high or too low.
Try charging at an ambient temperature between 10 °C and 30 °C (50 °F and 86 °F).
 - The terminals of the battery are dirty.
Remove the battery and wipe off the dirt with a dry cloth.
- Even when the camera on/off switch is set to [OFF] thus turning the camera off, it consumes power.

When the camera will not be used for a long time, remove the power plug from the electrical outlet in order to save power.

Using the Camera While Supplying It with Power (Supplying Power/Charging)

Since this camera, the optional AC Adaptor (DMW-AC11), and the items supplied with the optional Battery Charger (DMW-BTC15) are compatible with USB PD (USB Power Delivery), you can charge while the camera is being supplied with power.

Connect the USB connection cable, AC adaptor, and AC cable to the camera and turn on the power.

- Insert the battery into the camera.
- You can supply power to the camera body using a commercially available AC adaptor and USB connection cable.

*Recommended specifications for the commercially available AC adaptor

- Supports PD (Power Delivery)
- Supports 9 V/3 A (27 W) DC output
- USB Type-C terminal

*Use a USB connection cable with 27 W output or better for supplying power.

- Operation is not guaranteed with all commercially available devices.
- [] is displayed in the screen while power is being supplied.
- When the camera is on, charging will take longer than when the camera is off.



- If connecting with devices (PC, etc.) that do not support USB PD and turning the camera on, then this will supply power only.
- Turn off the camera before connecting or disconnecting the power plug.
- Remaining charge in the battery may decrease depending on usage conditions. When the battery level is depleted, the camera will turn off.
- Depending on the power supply capabilities of the connected device, it may not be possible to supply power.
- **For information about the high temperature display (→ [For information about the high temperature display: 136](#))**

Notifications Regarding Charging/Power Supply

❖ Power Indications

Indication on monitor

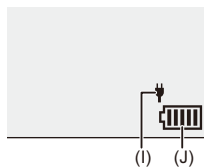

(I) USB connection cable supplying power

(J) Battery indication

	80 % or higher
	60 % to 79 %
	40 % to 59 %
	20 % to 39 %
	19 % or below
 Blinking in red	Low battery (The power indicator also blinks) <ul style="list-style-type: none"> • Charge or replace the battery.

- The battery level indicated on the screen is approximate.
The exact level varies depending on the environment and the operating conditions.



- **We recommend that genuine Panasonic batteries are used.**
There is a possibility that the use of non-genuine batteries can cause accidents or malfunctions that may lead to fire or explosion.
Please be advised that we are not liable for any accident or failure resulting from the use of non-genuine batteries.
- Do not leave any metal items (such as clips) near the contact areas of the power plug.
Otherwise, a fire and/or electric shocks may be caused by short-circuiting or the resulting heat generated.
- Do not use USB extension cables or USB conversion adaptors.
- The battery can be charged even when it still has some charge left, but it is not recommended that the battery charge be frequently topped up while the battery is fully charged.
- If there is a power outage or other problem with the electrical outlet, then charging may not complete successfully.
Reconnect the power plug.
- Do not connect to keyboard or printer USB ports, or to USB hubs.
- If the connected PC enters sleep status, then charging/power supply may stop.
- If the battery indication does not go to [Try not to use that battery.

[Power Save Mode]

This is a function to automatically turn the camera to sleep (power save) status or turn off the viewfinder/monitor if no operation is performed for a set time. Reduces battery consumption.

 ➔  ➔  ➔ **Select [Power Save Mode]**

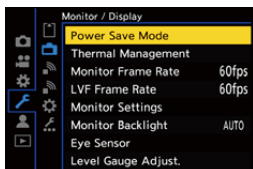

[Sleep Mode]	Sets the amount of time until the camera is put to sleep.	
[Sleep Mode(Wi-Fi)]	Sets the camera to sleep 15 minutes after being disconnected from Wi-Fi.	
[Auto LVF/ Monitor Off]	Sets the amount of time it takes for the viewfinder/monitor to turn off. (The camera is not turned off.)	
[Power Save LVF Shooting]	Puts the camera to sleep when the recording screen is being displayed on the monitor when automatic viewfinder/monitor switching is active.	
	[Time to Sleep]	Sets the amount of time until the camera is put to sleep.
	[Method of Activation]	Sets the screen where the camera is put to sleep. [Only Control Panel]: Puts the camera to sleep only when the control panel (→ Control Panel: 99) is displayed. [While Recording Standby]: Puts the camera to sleep from any screen during recording standby.

- To recover from [Sleep Mode], [Sleep Mode(Wi-Fi)], or [Power Save LVF Shooting], perform one of the following operations:
 - Press the shutter button halfway.
 - Set the camera on/off switch to [OFF] and then [ON] again.
- To recover from [Auto LVF/Monitor Off], press any button.



- [Power Save Mode] is not available in the following cases:
 - While connected to a PC
 - During video recording/video playback
 - During a [Time Lapse Shot]
 - When recording with [Stop Motion Animation] (when [Auto Shooting] is set)
 - When recording with [Live View Composite]
 - When recording with [Focus Transition]
 - During a [Slide Show]
 - During HDMI output for recording

Inserting Cards (Optional)



- Format the cards with the camera before use. (→[Card Format]: 669)

This camera supports the double card slot function.

When two cards are used, relay recording, backup recording, and allocation recording are available.

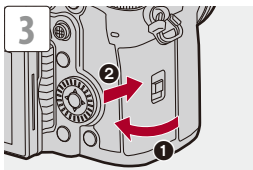
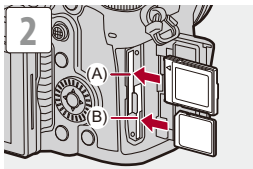
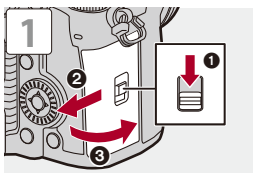

(A) Card slot 1: CFexpress card

(B) Card slot 2: SD card

- Match the orientation of the cards as shown in the figure and then insert them firmly until they click.



- You can set the way to record to card slots 1 and 2:
(→ [\[Double Card Slot Function\]: 670](#))
- You can set the folder and file names used for images saved within the DCIM folder:
(→ [\[Folder / File Settings\]: 675](#))
- You can switch the file name used when saving video to cards to CINE Style (the folder saved to is also switched):
(→ [\[Video File Name\]: 672](#))
- You can set the volume labels for cards when [Video File Name] is set to [CINE Style]:
(→ [\[CINE Style File Setting\]: 674](#))

❖ Card Access Indications

The card access light turns on while the card is being accessed.

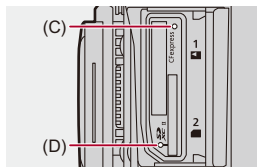

(C) Card access light for card slot 1

(D) Card access light for card slot 2



- The card may be warm just after the camera has been used.
- **Do not perform the following operations during access.**
The camera may operate incorrectly or the card and recorded images may be damaged.
 - Turn off the camera.
 - Remove the battery or card or disconnect the power plug.
 - Subject the camera to vibration, impacts, or static electricity.

❖ Removing a Card

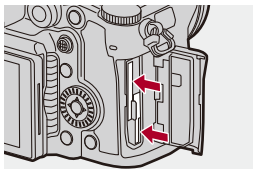

- 1 Open the card door.
- 2 Push the card until it clicks and then pull the card out straight.
 - Check that the card access lights are off before removing the card.

Attaching a Lens

- [Attaching a Lens Hood: 70](#)

The camera can use the dedicated lenses that comply with the Micro Four Thirds™ system lens mount specification (Micro Four Thirds mount).

For information about the lens that can be used (→ [Lenses That Can Be Used: 25](#))



- Check that the camera on/off switch is set to [OFF].
- Change the lens in a location where there is not a lot of dirt and dust.
If dirt or dust gets on the lens (→ [Dirt on the Image Sensor: 893](#))
- Change the lens while the lens cap is attached.

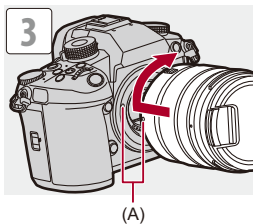
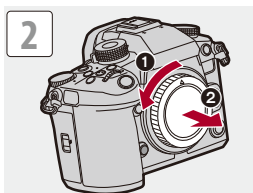
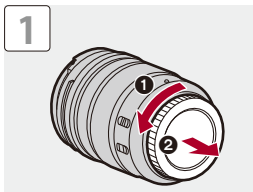

(A) Lens fitting marks

❖ Removing a Lens

- While pressing the lens release button (B), rotate the lens in the direction of the arrow until it stops and then remove it.

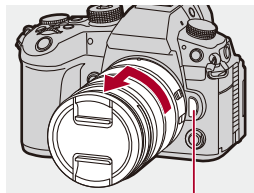

(B)



- When you have attached a lens that does not have a communication function with this camera, after turning on the camera, a message asking for confirmation of the lens information is displayed. You can register the focal length for the lens when you select [Yes]. You can also select from amongst already registered lens information. (→[[Lens Information](#)]: 300)
- You can change the settings so that the confirmation message is not displayed: (→[[Lens Info. Confirmation](#)]: 667)
- Insert the lens straight in.
Inserting this at an angle to attach it may damage the camera lens mount.
- After removing the lens, be sure to attach the body cap and the lens rear cap.

Attaching a Lens Hood

For recording against strong backlight, a lens hood can reduce the inclusion of unwanted light in images and drop in contrast resulting from the irregular reflection of light that occurs within the lens.

It allows you take more beautiful pictures by cutting out excess light.

When attaching the lens hood (flower shape) supplied with the interchangeable lens (H-ES12060/H-FS12060)

- Hold the lens hood by placing your fingers as shown in the figure.
- Do not hold the lens hood in such a way that it will become bent.



- 1 Align mark (C) (○) on the lens hood with the mark on the tip of the lens.**

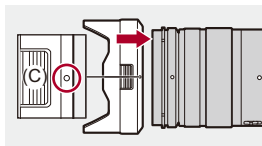

- 2 Rotate the lens hood in the direction of the arrow to align mark (D) (○) on the lens hood with the mark on the tip of the lens.**

- Attach the lens hood by rotating it until it clicks.

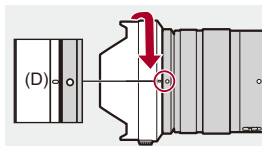

❖ Removing the Lens Hood (H-ES12060)

While pressing the lens hood button (E), rotate the lens hood in the direction of the arrow and then remove it.

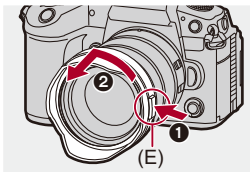

- The lens hood can be attached in the reverse direction when carrying the camera.

Example) H-ES12060

- 1 Align mark (D) (○) on the lens hood with the mark on the tip of the lens.
- 2 Attach the lens hood by rotating it in the direction of the arrow until it clicks.

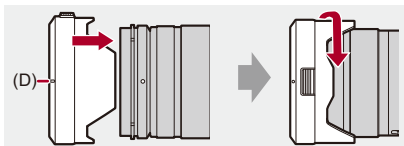

Adjusting the Monitor Direction and Angle

At the time of purchase, the monitor is stowed in the camera body.

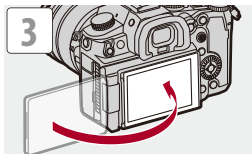
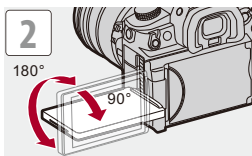
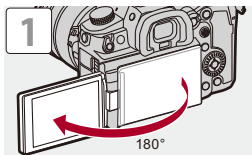



- The angles of adjustment are guides only.
- Do not apply an excessive force to the monitor. This may cause damage or malfunction.
- When not using the camera, close the monitor with the monitor surface facing in.



- You can set whether the screen flips or not depending on the facing or angle of the monitor during recording:
(→ [\[LVF/Monitor Disp. Set\]: 651](#))

Setting the Clock (When Turning On for the First Time)

When you turn the camera on for the first time, a screen to set the time zone and clock appears.

Be sure to set these settings before use to ensure images are recorded with the correct date and time information.

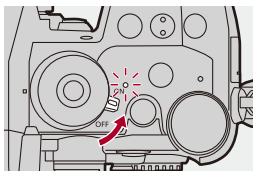

1 Set the camera on/off switch to [ON].

- The power indicator lights.
- If the language select screen is not displayed, proceed to Step 4.





2 When [Please set the language] appears, press or .

3 Set the language.

- Press ▲▼ to select the language and then press  or .

4 When [Please set the time zone] appears, press or .

5 Set the time zone.

- Press ◀▶ to select the time zone and then press  or .
- If you are using Daylight Savings [, press ▲. (The time will move forward by 1 hour.)
To return to the normal time, press ▲ again.



(A)

(A) Time difference from GMT (Greenwich Mean Time)

6 When [Please set the clock] appears, press or .

7 Set the clock.

◀▶: Select an item (year, month, day, hour, minute, or second).

▲▼: Select a value.

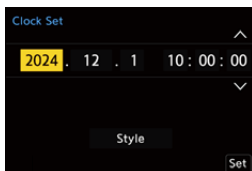

To set the display order and time display format

- To display the screen for setting the display order (B) and time display format (C), select [Style] by pressing ▶◀ and then press

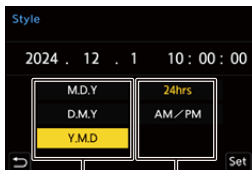
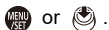

(B)

(C)

8 Confirm your selection.

- Press  or .

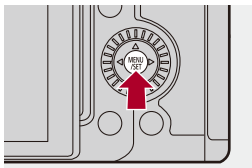

9 When [The clock setting has been completed.] appears, press or .



- If the camera is used without setting the clock, it will be set to “0:00:00 1/1/2024”.
- Clock settings are maintained for approx. 3 months using the built-in clock battery even without the battery.
(Leave the fully-charged battery in the camera for approx. 24 hours to charge the built-in battery.)



- [Time Zone] and [Clock Set] can be changed from the menu:
(→ [Time Zone]: 693, [Clock Set]: 693)
- You can set so that the power indicator does not light:
(→ [Power/Network Indicator]: 689)

Basic Operations

This chapter describes basic camera operations and the Intelligent Auto mode which helps you start recording immediately.

- [How to Hold the Camera: 80](#)
- [Selecting the Recording Mode: 82](#)
- [Camera Setting Operations: 83](#)
- [Monitor/Viewfinder Display Settings: 90](#)
- [Quick Menu: 97](#)
- [Control Panel: 99](#)
- [Menu Operation Methods: 102](#)
- [Entering Characters: 108](#)
- [Intelligent Auto Mode: 109](#)
- [Recording Using Touch Functions: 115](#)

How to Hold the Camera

To minimize camera shake, hold the camera so that it will not move during recording.

Hold the camera with both hands, keep your arms still at your side, and stand with your feet shoulder width apart.

- Hold the camera firmly by wrapping your right hand around the camera grip.
- Support the lens from below with your left hand.
- Do not cover the AF assist light (A) or microphone (B) with your fingers or other objects.
- Do not cover the fan inlet (C) and fan outlet (D) of the cooling fan with your hand, etc.

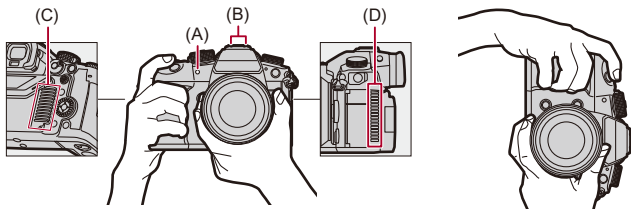

❖ Vertical Orientation Detection Function

This function detects when pictures were recorded with the camera held vertically orientated.

With the default settings, pictures are automatically played back vertically oriented.

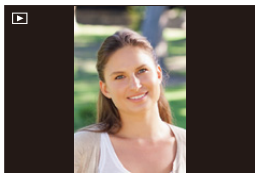

- If you set [Rotate Disp.] to [OFF], pictures will be played back without being rotated. (→[Rotate Disp.]: 586)



- When the camera is tilted significantly up or down, the vertical orientation detection function may not work correctly.



- You can set whether or not to record the camera's vertical orientation information during video recording:
(→[Vertical Position Info (Video)]: 667)

Selecting the Recording Mode

- 1 Press the mode dial lock button (1) to release the lock.**
 - The dial is locked if the mode dial lock button is depressed. Each press locks/unlocks the dial.
- 2 Rotate the mode dial (2) and adjust the recording mode.**

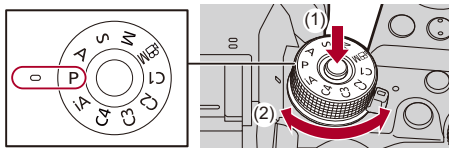

[iA]

Intelligent Auto mode (→ [Intelligent Auto Mode: 109](#))

[P]

Program AE mode (→ [Program AE Mode: 305](#))

[A]

Aperture-Priority AE mode (→ [Aperture-Priority AE Mode: 309](#))

[S]

Shutter-Priority AE mode (→ [Shutter-Priority AE Mode: 312](#))

[M]

Manual Exposure mode (→ [Manual Exposure Mode: 315](#))

[M]

Creative Video mode (→ [Recording Modes Specifically for Video \(Creative Video\): 394](#))

[C1]/[C2]/[C3]/[C4]

Custom mode (→ [Custom Mode: 622](#))

Camera Setting Operations

When changing the camera settings, operate the camera using the following operation parts.

To prevent accidental operation, you can disable operation with the operation lock lever.

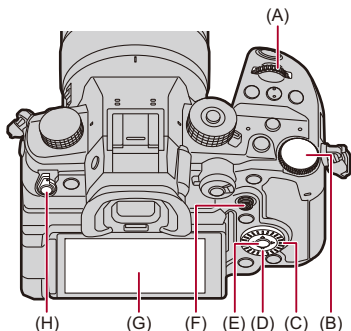

(A) Front dial () (→ [Front Dial/Rear Dial: 84](#))

(B) Rear dial () (→ [Front Dial/Rear Dial: 84](#))

(C) Control dial () (→ [Control Dial: 84](#))

(D) Cursor buttons (   ) (→ [Cursor Buttons: 85](#))

(E) [MENU/SET] button () (→ [\[MENU/SET\] Button: 85](#))

(F) Joystick (    / ) (→ [Joystick: 86](#))

(G) Touch screen (→ [Touch Screen: 87](#))

(H) Operation lock lever (→ [Operation Lock Lever: 89](#))

❖ Front Dial/Rear Dial

Rotate:

Selects an item or numeric value.

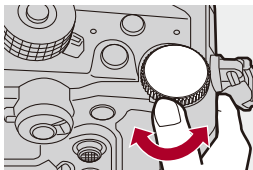
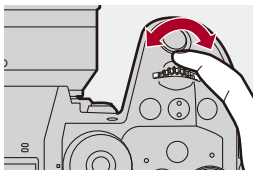

❖ Control Dial

Rotate:

Selects an item or numeric value.

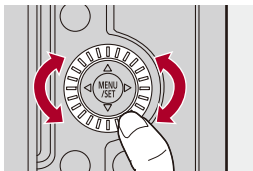

❖ Cursor Buttons

Press:

Selects an item or numeric value.

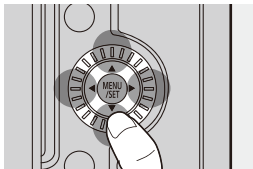

❖ [MENU/SET] Button

Press:

Confirms a setting.

- Displays the menu during recording and playback.

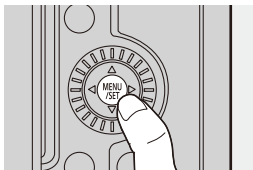

❖ Joystick

The joystick can be operated in 8 directions by tilting it up, down, left, right and diagonally and by pressing the center part.

(I) **Tilt:** Selects an item or numeric value, or moves a position.

- Operation is easier if you place your finger on the center of the joystick before tilting.
The joystick may not work as expected when the sides are pressed.

(J) **Press:** Confirms a setting.

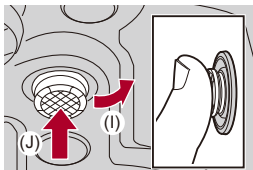

- You can disable the operations of operating parts.

(→ [\[Lock Lever Setting\]: 641](#))

❖ Touch Screen

Operations can be performed by touching the icons, slide bars, menus, and other items displayed on the screen.

Touch

Operation of touching and then lifting your finger from the touch screen.

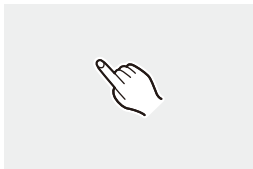

Drag

Operation of moving a finger while it touches the touch screen.

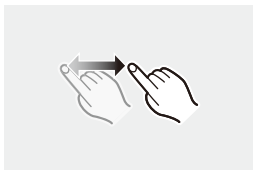

Pinch (widen/narrow)

Operations of widening the distance between two fingers (pinch out) and narrowing the distance between two fingers (pinch in) while they are touching the touch screen.



- If you will use a commercially available monitor protection sheet, observe the precautions for the sheet.
(Visibility and operability may be impaired depending on the type of monitor protection sheet.)



- Touch operations can be disabled:
(→ [\[Touch Settings\]: 640](#))

❖ Operation Lock Lever

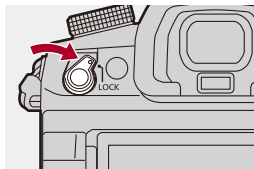

Aligning the operation lock lever with the [LOCK] position enables disabling of the operation parts set in [Lock Lever Setting] of the [Custom] ([Operation]) menu. (→[\[Lock Lever Setting\]: 641](#))

Monitor/Viewfinder Display Settings

- [Setting the Viewfinder: 90](#)
- [Switching Between the Monitor and Viewfinder: 91](#)
- [Switching the Display Information: 94](#)

Setting the Viewfinder

❖ Adjusting the Viewfinder Diopter

Rotate the diopter adjustment dial while looking through the viewfinder.

- Adjust until you can clearly see the text on the viewfinder.

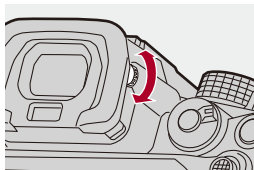

Switching Between the Monitor and Viewfinder

With the default settings, automatic viewfinder/monitor switching is set. When you look through the viewfinder, the eye sensor (A) works and the camera switches from monitor display to viewfinder display. You can switch to viewfinder display or monitor display with [LVF] button (B).

Press [LVF].

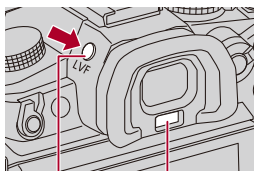

(B)

(A)

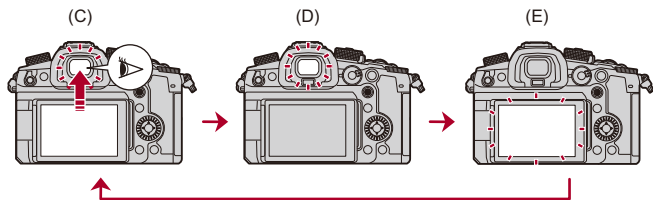

(C) Automatic viewfinder/monitor switching

(D) Viewfinder display

(E) Monitor display

❖ Simultaneous Display on the Monitor and Viewfinder

When automatic viewfinder/monitor switching (C), if the monitor is rotated towards the lens, the recording screen is displayed on the monitor even when you look into the viewfinder.

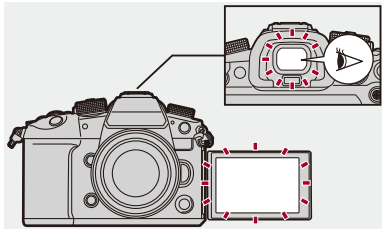



- The eye sensor may not work correctly due to the shape of eyeglasses, the way the camera is held, or bright light shining around the eyepiece.
- During video playback or slide show, automatic viewfinder/monitor switching does not work.
- Simultaneous display on the monitor and viewfinder is not possible if the following functions are used while the video frame rate is 200p or more or when using [Proxy Recording].
 - HDMI output
 - Wi-Fi connection with a smartphone
 - Tethered recording



- To focus when looking through the viewfinder:
(→[Eye Sensor AF]: 639)
- The sensitivity of the eye sensor can be changed:
(→[Eye Sensor]: 682)
- You can set the display speed for live view on the monitor when recording pictures:
(→[Monitor Frame Rate]: 679)
- You can set the display speed for live view on the viewfinder when recording pictures.
(→[LVF Frame Rate]: 680)
- You can adjust the brightness, coloring, red or blue tints, etc., of the monitor/viewfinder:
(→[Monitor Settings]/[Viewfinder]: 680)
- You can adjust monitor/viewfinder luminance:
(→[Monitor Backlight]/[LVF Luminance]: 681)

Switching the Display Information

Press **[DISP.]**.

- The display information is switched.

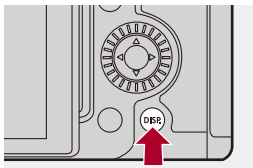

❖ Recording Screen

Monitor

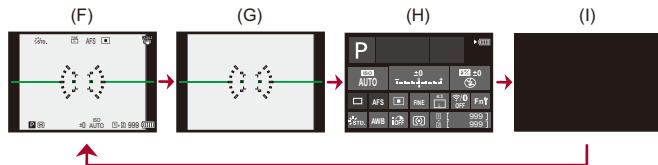

(F) With information

(G) Without information

(H) Control panel

(I) Turned off (black)

Viewfinder

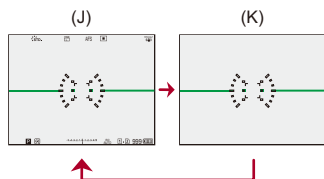

(J) With information

(K) Without information



- Press [**↔**] to switch between display/hide of the level gauge.
This can also be set by using [Level Gauge]. (→[\[Level Gauge\]: 656](#))



- Control panel operation (→[Control Panel: 99](#))
- You can hide the control panel and black screen:
(→[\[Show/Hide Monitor Layout\]: 657](#))
- The display can be changed so that live view and display information do not overlap:
(→[\[LVF/Monitor Disp. Set\]: 651](#))
- You can display the outline for the live view:
(→[\[Framing Outline\]: 657](#))

❖ Playback Screen

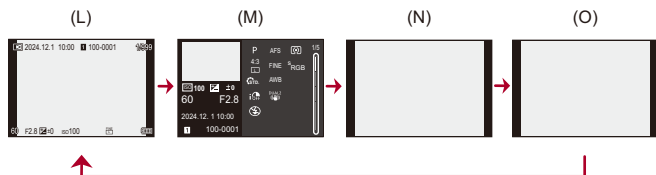

(L) With information

(M) Detailed information display

- Pressing ▲▼ switches the display information. (→ [Detailed information display: 869](#))

(N) Without information

(O) Without blinking highlights

- This is a screen without blinking highlights display that is shown when [Blinking Highlights] of the [Custom] ([Monitor / Display (Photo)]) is set to [ON].

In other than this screen, overexposed parts of the screen will blink. (→ [Blinking Highlights: 653](#))

Quick Menu

This menu enables you to quickly set functions that are frequently used during recording without calling up the menu screen. You can also change the Quick menu display method and the items to display.

1 Display the Quick menu.

- Press [Q].

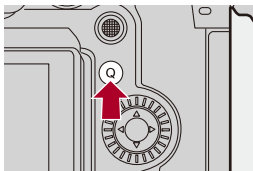



2 Select a menu item.

- Press ▲▼◀▶.
- Directions on the diagonal can also be selected using the joystick.
- Selection is also possible by rotating .
- Selection is also possible by touching a menu item.



3 Select a setting item.

- Rotate  or .
- Selection is also possible by touching a setting item.



4 Close the Quick menu.

- Press the shutter button halfway.
- You can also close the menu by pressing [Q].

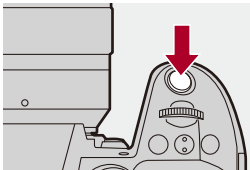

- Some items cannot be set depending on the recording mode or camera settings.



- The Quick menu can be customized:
(→ [Quick Menu Customization: 615](#))

Control Panel

This screen allows you to view the current recording settings on the monitor. You can also touch the screen to change the settings.

In the [P] mode (Creative Video mode), the display changes to one especially for video.

- For information about the screen (→ [Control Panel: 858](#), [Control Panel \(Creative Video Mode\): 861](#))

1 Display the control panel.

- Press [DISP.] several times.

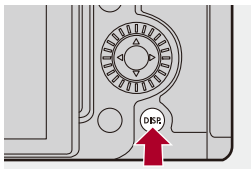

2 Touch the items.

Example) Changing the AF mode



3 Change the setting.

- Touch the setting item.
- Refer to the pages explaining each item for information on how to change the settings.

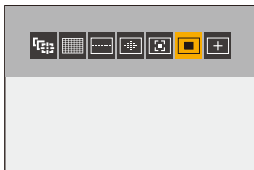

4 Touch [Set].

❖ Changing Directly Using the Dial

Steps **2** to **4** can also be changed using the following operations.

- 1 Press one of ▲▼◀▶ to enable selection of items.
 - Selected items are displayed in yellow.
- 2 Press ▲▼◀▶ to select an item.
 - Selection is also possible by rotating 🌞 or ⚙️.
- 3 Rotate 🌞 to change the settings values.

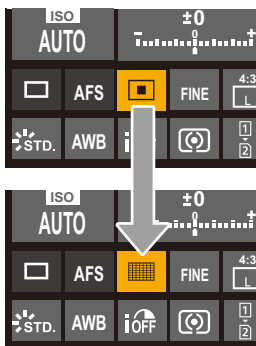

- Some items cannot be set depending on the recording mode or camera settings.

Menu Operation Methods

- [Reset]: 107

In this camera, the menu is used for setting a wide variety of functions and performing camera customizations.

Menu operations can be performed using the cursors, joystick, dial, or by touch.

Configuration and operation parts of the menu

The menu can be operated by pressing ◀▶ to move between menu screens.

Use the operation parts indicated below to operate the main tab, the sub tab, the page tab, and menu items without moving to the corresponding menu levels.

- You can also operate by touching the icons, menu items, and setting items.

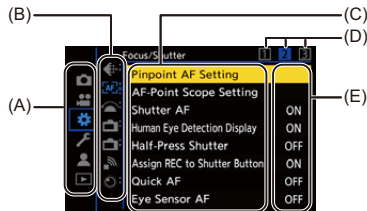





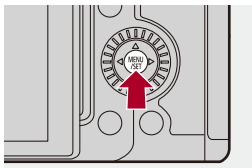

- (A) Main tab ([Q] button)
- (B) Sub tab (☀️)
- (C) Menu item (☀️)
- (D) Page tab (☀️)
- (E) Setting item

1 Display the menu.

- Press .





2 Select a main tab.

- Press   to select a main tab and then press .
- You can also perform the same operation by rotating  to select the main tab and then pressing  or .



3 Select a sub tab.



- Press ▲▼ to select a sub tab and then press ►.
- You can also perform the same operation by rotating  to select the sub tab and then pressing  or .
- If there are page tabs (D), then after the page tabs have finished switching, the next sub tab is switched to.



(D)







4 Select a menu item.

- Press ▲▼ to select a menu item and then press ►.
- You can also perform the same operation by rotating  to select the menu item and then pressing  or .



5 Select a setting item and then confirm your selection.

- Press ▲▼ to select a setting item and then press  or .
- You can also perform the same operation by rotating  to select the setting item and then pressing  or .

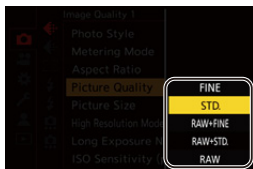

6 Close the menu.

- Press the shutter button halfway.
- You can also close the menu by pressing [>] several times.

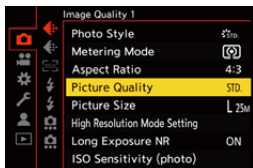



❖ Displaying Descriptions About Menu Items and Settings

If you press [DISP.] while a menu item or setting item is selected, a description about the item is displayed on the screen.



❖ Grayed Out Menu Items

Menu items that cannot be set are displayed grayed out.

If you press  or  while a grayed out menu item is selected, the reason why it cannot be set is displayed.

- The reason why a menu item cannot be set may not be displayed depending on the menu item.



[Reset]

Return each of the following settings to the default setting:

- Recording settings
- Network settings (settings of [Streaming Setup], [LAN / Wi-Fi Setup], and [Bluetooth])
- Setup and custom settings (other than [Streaming Setup], [LAN / Wi-Fi Setup], and [Bluetooth])

 →  →  → **Select [Reset]**

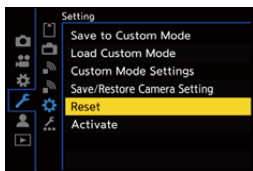

- If the setup and custom settings are reset, the [Playback] menu is also reset.
- The [LUT Library] is returned to the default settings when setup and custom settings are reset. Registered LUTs are deleted.
- If the setup and custom settings are reset, [Lens Information] in [Image Stabilizer] in the [Photo] ([Others (Photo)]) menu/[Video] ([Others (Video)]) menu is also returned to the default setting.
- The folder numbers and clock settings are not reset.











- List of default settings and settings that can be reset (→ [List of Default Settings/Custom Saving/Settings Available for Copying: 919](#))

Entering Characters



Follow the steps below when the character entry screen is displayed.

1 Enter characters.

- Press ▲▼◀▶ to select characters and then press  or  until the character to enter is displayed. (Repeat this)
- To repeatedly enter the same character, rotate  or  to the right to move the entry position cursor.
- If you select an item and press  or , you can perform the following operations:
 - []: Change the character type to [A] (upper case characters), [a] (lower case characters), [1] (numbers), and [&] (special characters)
 - []: Enter a blank
 - [Delete]: Delete a character
 - [<]: Move the entry position cursor to the left
 - [>]: Move the entry position cursor to the right
- When entering a password, (A) shows the number of characters you have entered and the number of characters you can enter.



2 Complete entering.

- Select [Set] and then press  or .

Intelligent Auto Mode



The [iA] mode (Intelligent Auto mode) can record images using settings automatically selected by the camera.

The camera detects the scene to set the optimal recording settings automatically to match the subject and recording conditions.

1 Set the recording mode to [iA].

- Set the mode dial. (→ [Selecting the Recording Mode: 82](#))

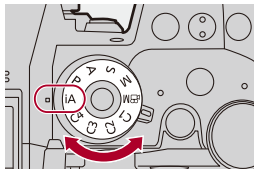

2 Aim the camera at the subject.

- When the camera detects the scene, the recording mode icon changes.

(Automatic Scene Detection)



3 Adjust the focus.

- Press the shutter button halfway.
- Once the subject is in focus, the focus icon lights.
(When the subject is not in focus, the indication blinks.)
- [AF-ON] of the AF mode works and the AF area is displayed aligned to any humans.

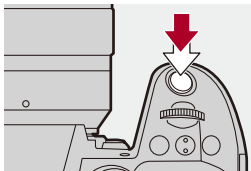





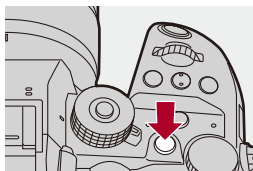
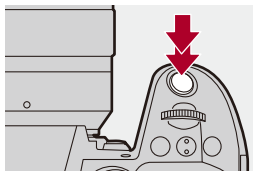



4 Start recording.

- Press the shutter button fully to take pictures.
- Press the video rec. button to record videos.



- Backlight compensation operates automatically to prevent subjects from appearing dark when there is a backlight.

❖ Types of Automatic Scene Detection

		Taking pictures	Recording video
	i-Portrait ^{*1}	✓	✓
	i-Scenery	✓	✓
	i-Macro	✓	✓
	i-Night Portrait ^{*2}	✓	
	i-Night Scenery	✓	
	i-Food	✓	
	i-Sunset	✓	
	i-Low Light		✓
	iA ^{*3}	✓	✓

*1 Detected when [Detecting Subject] ([Type of Subject]) in the [Photo] ([Focus]) menu is set to [HUMAN].

*2 Detected when using an external flash.

*3 Detected when [Detecting Subject] ([Type of Subject]) in the [Photo] ([Focus]) menu is set to other than [HUMAN].



- If none of the scenes are applicable, recording is with [iA] (standard setting).
- Different scene types may be selected for the same subject depending on the recording conditions.
- Not all subjects can be detected according to the settings.
- When [Detecting Subject] ([Type of Subject]) is [ANIMAL], some subjects that are not animals may be detected as animals.

❖ AF Mode

Changing the AF mode.

- Each press of [] changes the AF mode.
- The mode can also be changed by touching the screen or pressing and holding the joystick.
- [AF Detection Setting] is fixed to [ON].
- The [Detecting Subject] setting is maintained for any recording mode other than [iA] mode. (→ [Automatic Detection: 192](#))

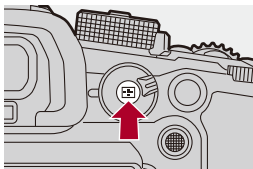

[] ([Full Area AF])

Detects subjects for recording and focuses.



- You can switch the subject to be focused by either touching the white AF area or moving the joystick ▲▼◀▶.
-

[] ([Tracking])

When the focus mode is set to [AFC], the AF area follows the movement of the subject, maintaining focusing.



Aim the AF area over the subject and then press and hold the shutter button halfway.



- The camera will track the subject while the shutter button is pressed halfway or fully.



- For information about AF modes (→ [Automatic Detection: 192](#), [\[Tracking\]: 196](#))

Flash

When recording using a flash, the camera switches to the appropriate flash mode for the recording conditions.

When Slow Sync. (, []), be careful with regard to camera shake because the shutter speed becomes slow.



- For information about external flashes (→ [Using an External Flash \(Optional\): 373](#))

Recording Using Touch Functions

- [Touch AF/Touch Shutter: 115](#)
- [Touch AE: 118](#)

Touch AF/Touch Shutter



Touch functions allow you to focus on the point that you touch, release the shutter, etc.



- With the default settings, the Touch Tab is not displayed.
Set [Touch Tab] to [ON] in [Touch Settings] in the [Custom] ([Operation]) menu.
(→ [\[Touch Settings\]: 640](#))

1 Touch [**<**].

2 Touch the icon.

- The icon switches each time you touch it.



☞ **Touch AF**

Focus on the touched position.

☞ **Touch Shutter**

Record with focus on the touched position.

☞ **OFF**

3 (When set to anything other than OFF) Touch the subject.





- When the Touch Shutter fails, the AF area first turns red and then disappears.



- For information about operations to move the AF area (→ [AF Area Operations: 206](#))
- It is also possible to optimize the focus and brightness on the touched position: (→ [Focus on and Adjust Brightness for the Touched Position \(\[AF+AE\]\): 211](#))

Touch AE



This function adjusts the brightness according to a touched position. When a subject's face appears dark, you can make the screen brighter to match the face.



- With the default settings, the Touch Tab is not displayed.
Set [Touch Tab] to [ON] in [Touch Settings] in the [Custom] ([Operation]) menu.
(→[Touch Settings]: 640)

1 Touch [].

2 Touch [].

- The Touch AE settings screen appears.



3 Touch the subject to which you wish to adjust the brightness.

- To return the position to which to adjust the brightness to the center, touch [Reset].



4 Touch [Set].

❖ How to Disable Touch AE

Touch [].



- When the following function is being used, Touch AE is not available:
 - [Live Cropping]



- You can also adjust both the focus and brightness to those of the position you touch. (At this time, Touch AE is not available):
(→ [Focus on and Adjust Brightness for the Touched Position \(\[AF+AE\]\): 211](#))

Taking Pictures

These are the basic operations and settings for taking pictures.

- [Basic Picture Operations: 121](#)
- [\[Aspect Ratio\]: 124](#)
- [\[Picture Size\]: 125](#)
- [\[Picture Quality\]: 127](#)

Basic Picture Operations



1 Select the recording mode ([iA]/[P]/[A]/[S]/[M]).

- Set the mode dial. (→ [Selecting the Recording Mode: 82](#))

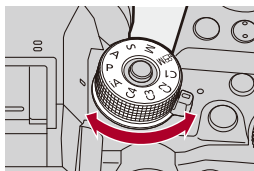

2 Adjust the focus.

- Press the shutter button halfway (press it gently).

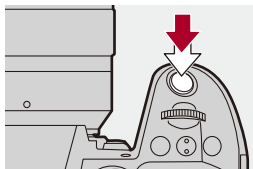

- The aperture value (A) and shutter speed (B) are displayed. (When the correct exposure cannot be obtained, the indications blink in red.)
- Once the subject is in focus, the focus icon (C) lights. (When the subject is not in focus, the indication blinks.)
- You can also perform the same operation by pressing [AF ON].

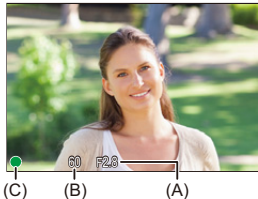

3 Start recording.

- Press the shutter button fully (press it further).

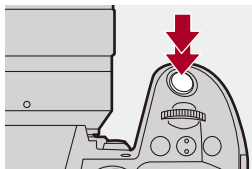

- Recorded pictures can be displayed automatically by setting [Auto Review] of the [Custom] ([Monitor / Display (Photo)]) menu. You can also change the picture display duration to your preferred setting. (→ [\[Auto Review\]: 647](#))



- **With the default settings, you cannot take a picture until the subject is brought into focus.**

If you set [Focus/Shutter Priority] in the [Custom] ([Focus/Shutter]) menu to [BALANCE] or [RELEASE], you will be able to take a picture even when the subject is not in focus. (→ [\[Focus/Shutter Priority\]: 634](#))

[Aspect Ratio]



You can select the image aspect ratio.

MENU / SET → **[CAMERA]** → **[ASPECT RATIO]** → **Select [Aspect Ratio]**



[4:3]

Aspect ratio of a 4:3 monitor

[3:2]

Aspect ratio of a standard film camera

[16:9]

Aspect ratio of a 16:9 TV

[1:1]

Square aspect ratio



- A frame for trimming (cropping) can be displayed on the recording screen:
(→[Frame Marker]: 460)

[Picture Size]



Sets the picture's image size.

MENU / SET → **[CAMERA]** → **[MENU]** → **Select [Picture Size]**

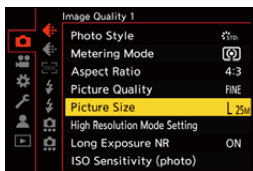

[Aspect Ratio]	[Picture Size]	
[4:3]	[L] (25M)	5776×4336
	[M] (12.5M)	4096×3072
	[S] (6.5M)	2944×2208
	[XS] (3M)	1920×1440
[3:2]	[L] (22M)	5776×3848
	[M] (11M)	4096×2728
	[S] (5.5M)	2944×1960
	[XS] (2.5M)	1920×1280
[16:9]	[L] (18.5M)	5776×3248
	[M] (9.5M)	4096×2304
	[S] (5M)	2944×1656
	[XS] (2M)	1920×1080
[1:1]	[L] (19M)	4336×4336
	[M] (9.5M)	3072×3072
	[S] (5M)	2208×2208
	[XS] (2M)	1440×1440

- When [Crop Zoom(Photo)] is set, [Cr] is displayed on the image size.



- When the following functions are being used, [Picture Size] is not available:
 - [RAW] ([Picture Quality])
 - High Resolution mode

[Picture Quality]



Set the compression rate used for storing pictures.

MENU / **SET** → [**📷**] → [**⏪**] → **Select [Picture Quality]**

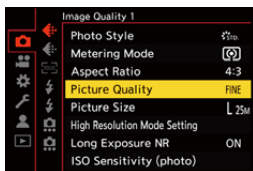

[FINE]

JPEG images that give priority to image quality.

File format: JPEG

[STD.]

JPEG images of standard image quality.

This is useful for increasing the number of recordable pictures without changing the picture size.

File format: JPEG

[RAW+FINE]/[RAW+STD.]

This records RAW and JPEG images ([FINE] or [STD.]) simultaneously.

File format: RAW+JPEG

[RAW]

This records RAW images.

File format: RAW



Note on RAW

RAW format refers to a data format of images that have not been processed on the camera.

Playback and editing of RAW images require the camera or the dedicated software.

- You can process RAW images on the camera. (→[\[RAW Processing\]: 571](#))
- Use software (“SILKYPIX Developer Studio” by Adwaa) to process and edit RAW files on a PC. (→[SILKYPIX Developer Studio SE: 831](#))



- RAW images are always recorded in the [L] size of the [4:3] aspect ratio.
- When you delete an image recorded with [RAW+FINE] or [RAW+STD.] on the camera, both the RAW and JPEG images will be deleted simultaneously.
- When the following function is being used, [Picture Quality] is not available:
 - High Resolution mode



- You can assign the function that records a RAW image and a JPEG image simultaneously once only to an Fn button:
 - (→[\[1 Shot RAW+JPG\]: 603](#))
- Selects a Color Space setting from [sRGB] or [AdobeRGB]:
 - (→[\[Color Space\]: 632](#))

Recording Videos

These are the basic operations and settings for recording videos.

- Please also refer to the following chapters for more detailed information about recording videos:
 - [Video Settings: 393](#)
 - [Special Video Recording: 464](#)
 - [HDMI Output \(Video\): 517](#)
- [Basic Video Operations: 130](#)
- [\[System Frequency\]: 138](#)
- [\[Rec. File Format\]: 140](#)
- [\[Rec Quality\]: 142](#)
- [RAW Video Recording: 159](#)
- [Proxy Recording: 161](#)
- [\[Image Area of Video\]: 166](#)

Basic Video Operations



It is possible to record video with a maximum resolution of 5.8K (5760×4320) on this camera.

It also supports switching of the system frequency and 3 types of recording file format; MP4, MOV, and Apple ProRes.

In the [M] mode (Creative Video mode), which is specifically for video recording, you can use all of the video functions.

1 Select the recording mode.

- Set the mode dial. (→ [Selecting the Recording Mode: 82](#))

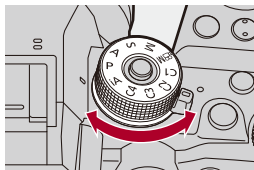

2 Start recording.

- Press the video rec. button (A).
- You can also perform the same operation by pressing the sub video rec. button (B).
- Release the video rec. button right after you press it.
- During video recording, the front tally lamp (C) and rear tally lamp (D) light.

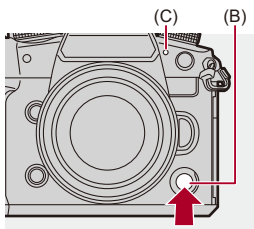
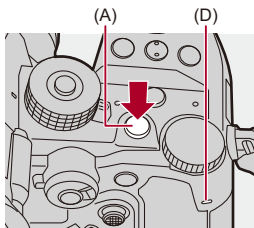

3 Stop recording.

- Press the video rec. button (A) again.
- You can also perform the same operation by pressing the sub video rec. button (B).

❖ Screen Displays While Video Recording

The live view angle of view changes to the angle of view for video recording, and video recording time (E) and elapsed recording time (F) are displayed.

- “h” is an abbreviation for hour, “m” for minute and “s” for second.
- The recording state indication (G) and card access indication (H) turn red while videos are being recorded.

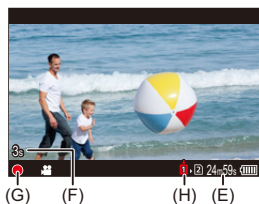

- If maintaining focus on the subject is difficult during video recording with AF, press the shutter button halfway to re-adjust the focus.

❖ Exposure Control While Video Recording

Videos will be recorded using the aperture value, shutter speed, and ISO sensitivity settings below.

Recording mode	Aperture value/shutter speed/ISO sensitivity
[iA]	The camera automatically makes the settings to suit the scene. (→ Types of Automatic Scene Detection: 112)
[P]/[A]/[S]/[M]	The settings vary depending on the [Auto Exposure in P/A/S/M] in the [Custom] ([Image Quality]) menu. The default setting is [ON]. (→ Auto Exposure in P/A/S/M: 632) [ON]: Records with values set automatically by the camera. [OFF]: Records with the values set in the [P]/[A]/[S]/[M] modes.
[M]	Records with manually set values.

❖ Size Interval for Dividing Files

A new file will be created to continue recording if the continuous recording time or the file size exceeds the following conditions.

- (A) Using an SDHC memory card
- (B) Using an SDXC memory card
- (C) Using an external SSD
- (D) Using a CFexpress card

[Rec. File Format]	Resolution	Bit rate	Recording media	File division	
				Continuous recording time	File size
[MP4]	[FHD]	All	(A)	30 minutes	4 GB
			(B)		
			(C)		
			(D)		
	Other than [FHD]		(A)	30 minutes	4 GB
			(B)	3 hours 4 minutes	96 GB
			(C)		
			(D)		
(D)					
[MOV]	All	600 Mbps or less	(A)	30 minutes	4 GB
			(B)	3 hours 4 minutes	192 GB
			(C)		
			(D)		
		800 Mbps or more	(A)		
			(B)		
			(C)	3 hours 4 minutes	640 GB
			(D)	4 minutes	

[Apple ProRes]	[FHD]	All	(A)	30 minutes	4 GB	
			(B)	3 hours 4 minutes	192 GB	
			(C)			
			(D)			
	Other than [FHD]		(A)			
			(B)			
			(C)	3 hours	640 GB*	
			(D)	4 minutes		

* When the recording quality is [Apple ProRes RAW HQ] or [Apple ProRes RAW], recording is stopped.



- When the remaining capacity of the battery or card gets low during video recording, the tally lamps blink at long intervals. When there is no remaining capacity in the battery or card, video recording is stopped and the tally lamps blink at short intervals.
- If an operation such as a zoom or button operation is performed during video recording, that operation sound may be recorded.
- The lens operation sound (AF and image stabilizer) may be recorded to video.
- If the operation sound of pressing the video rec. button or sub video rec. button to end recording bothers you, try the following:
 - Record the video about 3 seconds longer, and then divide the last part of the video using [Video Divide] in the [Playback] ([Edit Image]) menu.
 - Use the Shutter Remote Control (DMW-RS2: optional) for recording.
- Depending on the type of card, the card access indication may appear for a while after video recording. This is not a malfunction.
- Even when playback is performed on a supported device, situations may occur where image or sound quality is poor, recording information is not displayed correctly, or playback is not possible, for example.
If you experience any of these, play them back on the camera.
- Video recording is not possible while you are using the following functions:
 - [Time Lapse Shot]
 - [Stop Motion Animation]

• **For information about the high temperature display**

When the temperature of the camera rises, [] appears blinking on the screen. If you continue to use the camera, a message indicating that the camera cannot be used is displayed on the screen and some functions, such as recording and HDMI output, will be stopped. Wait for the camera to cool down and for the message indicating that the camera can be used again. When the message indicating that it can be used again is displayed, turn the camera off then on again.



- You can set the temperature during video recording at which the camera automatically stops recording:
(→ [\[Thermal Management\]: 679](#))
- You can switch the recording screen display to suit video recording just as with the [M] mode:
(→ [\[Video-Priority Display\]: 661](#))
- You can set whether to have the tally lamps light or turn off. You can also change the brightness of the tally lamps:
(→ [\[Tally Lamp\]: 663](#))
- You can display a red frame on the recording screen that indicates that video is being recorded:
(→ [\[Red REC Frame Indicator\]: 661](#))

[System Frequency]



This changes the system frequency of videos that are recorded and played back with the camera.

The default setting is for the system frequency to be set to the TV broadcast system for the region where the camera was purchased.

 →  →  → **Select [System Frequency]**

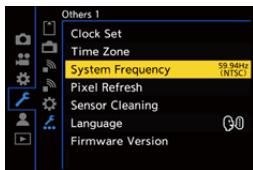

[59.94Hz (NTSC)]

System frequency for regions using the NTSC broadcasting system

[50.00Hz (PAL)]

System frequency for regions using the PAL broadcasting system

[24.00Hz (CINEMA)]

System frequency for producing cinema film



- After changing the setting, turn the camera off and on.
- If you record using a system frequency that differs from the broadcasting system of your region, it may not be possible for you to properly play back videos on your TV.

We recommend using the setting as it was at the time of purchase if you are unsure about broadcasting systems or if you will not be involved in producing cinema film.

- After changing the setting, it is recommended to insert another card and format it with this camera.
 - Make the [System Frequency] setting the same for when you are recording and playing back.

[Rec. File Format]



Sets the recording file format of videos to be recorded.

→ → → **Select [Rec. File Format]**



[MP4]

This file format is suitable for playback on PCs.

[MOV]

This file format is suitable for image editing.

[Apple ProRes]

Records using the Apple ProRes codec.

This file format is suitable for image editing.



- The following types of video cannot be recorded to SD cards. Use CFexpress cards.
 - [MOV] video with bit rate of 800 Mbps or more
 - [Apple ProRes] video with resolution other than FHD
 - Variable frame rate video with a recording quality with image compression mode ALL-Intra

[Rec Quality]



Sets the image quality of videos to be recorded.

The image qualities you can select depend on the recording mode, [System Frequency], and [Rec. File Format] settings.

The [Image Area of Video] setting items you can select depend on the [Rec Quality] settings.

[Rec Quality] settings can also be made using [Filtering] (→ [Filtering]: 156) to display only items that meet your conditions and [add to list] (→ [add to list]: 157) to register recording qualities you use often.

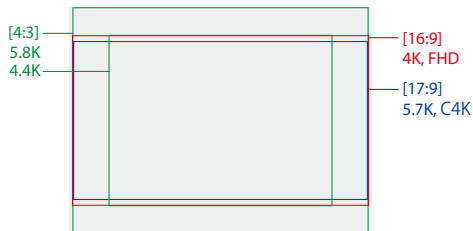

- The above shows some of the recording qualities available.

MENU SET → **[CAMERA]** → **[FILMSTRIP]** → **Select [Rec Quality]**

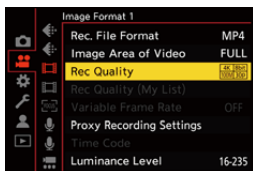

- To record video with a bit rate of 72 Mbps or more, you require an SD card with the corresponding Speed Class.
- Video with a bit rate of 800 Mbps or more cannot be recorded to an SD card. Use a CFexpress card.
- [Apple ProRes] video with a resolution other than FHD cannot be recorded to an SD card. Use a CFexpress card.
- For information about the cards that can be used (→ [SD Cards That Can Be Used with This Camera: 27](#))

❖ [Rec. File Format]: [MP4]

- YUV, Bit value, Image compression:
 - [10bit] recording quality: 4:2:0, 10 bit, Long GOP
 - [8bit] recording quality: 4:2:0, 8 bit, Long GOP
- Audio format: AAC (2ch)

(A) Recording frame rate

(B) Bit rate (Mbps)

(C) Video compression format (**HEVC**: H.265/HEVC, **AVC**: H.264/MPEG-4 AVC)

[System Frequency]: [59.94Hz (NTSC)]

[Rec Quality]	[Image Area of Video]		Resolution	Aspect ratio	(A)	(B)	(C)
	FULL	PIXEL PIXEL					
[4K/10bit/100M/60p]	✓	✓	3840×2160	16:9	59.94p	100	HEVC
[4K/10bit/72M/30p]	✓	✓	3840×2160	16:9	29.97p	72	HEVC
[4K/8bit/100M/30p]	✓	✓	3840×2160	16:9	29.97p	100	AVC
[4K/10bit/72M/24p]	✓	✓	3840×2160	16:9	23.98p	72	HEVC
[4K/8bit/100M/24p]	✓	✓	3840×2160	16:9	23.98p	100	AVC
[FHD/8bit/28M/60p]	✓	✓	1920×1080	16:9	59.94p	28	AVC
[FHD/8bit/20M/30p]	✓	✓	1920×1080	16:9	29.97p	20	AVC
[FHD/8bit/24M/24p]	✓	✓	1920×1080	16:9	23.98p	24	AVC

[System Frequency]: [50.00Hz (PAL)]

[Rec Quality]	[Image Area of Video]		Resolution	Aspect ratio	(A)	(B)	(C)
	FULL	PIXEL PIXEL					
[4K/10bit/100M/50p]	✓	✓	3840×2160	16:9	50.00p	100	HEVC
[4K/10bit/72M/25p]	✓	✓	3840×2160	16:9	25.00p	72	HEVC
[4K/8bit/100M/25p]	✓	✓	3840×2160	16:9	25.00p	100	AVC
[FHD/8bit/28M/50p]	✓	✓	1920×1080	16:9	50.00p	28	AVC
[FHD/8bit/20M/25p]	✓	✓	1920×1080	16:9	25.00p	20	AVC

❖ [Rec. File Format]: [MOV]

- YUV, Bit value, Image compression:
 - [422/10-I] recording quality: 4:2:2, 10 bit, ALL-Intra
 - [422/10-L] recording quality: 4:2:2, 10 bit, Long GOP
 - [420/10-L] recording quality: 4:2:0, 10 bit, Long GOP
 - [420/8-L] recording quality: 4:2:0, 8 bit, Long GOP
- Audio format: LPCM (2ch/4ch)
4-channel audio can be recorded when the XLR Microphone Adaptor (DMW-XLR2: optional) is connected by setting [4ch Audio Recording] to [XLR] or [XLR+CAMERA].

 M: Only available in Creative Video mode.

(A) Recording frame rate

(B) Bit rate (Mbps)

(C) Video compression format (**HEVC**: H.265/HEVC, **AVC**: H.264/MPEG-4 AVC)

[System Frequency]: [59.94Hz (NTSC)]								
[Rec Quality]		[Image Area of Video]		Resolution	Aspect ratio	(A)	(B)	(C)
		FULL	PIXEL PIXEL					
[5.8K/30p/420/10-L]	✓	✓		5760×4320	4:3	29.97p	200	HEVC
[5.8K/24p/420/10-L]	✓	✓		5760×4320	4:3	23.98p	200	HEVC
[5.7K/60p/420/10-L]	✓	✓		5728×3024	17:9	59.94p	300	HEVC
[5.7K/48p/420/10-L]	✓	✓		5728×3024	17:9	47.95p	300	HEVC
[5.7K/30p/420/10-L]	✓	✓		5728×3024	17:9	29.97p	200	HEVC
[5.7K/24p/420/10-L]	✓	✓		5728×3024	17:9	23.98p	200	HEVC
[4.4K/60p/420/10-L]	✓		✓	4352×3264	4:3	59.94p	300	HEVC
[4.4K/48p/420/10-L]	✓		✓	4352×3264	4:3	47.95p	300	HEVC
[C4K/120p/420/10-L]	✓	✓	✓	4096×2160	17:9	119.88p	300	HEVC
[C4K/60p/422/10-I(H)]*		✓	✓	4096×2160	17:9	59.94p	800	AVC
[C4K/60p/422/10-I(L)]*		✓	✓	4096×2160	17:9	59.94p	600	AVC
[C4K/60p/422/10-L]		✓	✓	4096×2160	17:9	59.94p	200	AVC
[C4K/60p/420/10-L]		✓	✓	4096×2160	17:9	59.94p	200	HEVC
[C4K/60p/420/8-L]		✓	✓	4096×2160	17:9	59.94p	150	AVC
[C4K/48p/422/10-I(H)]*		✓	✓	4096×2160	17:9	47.95p	800	AVC

[C4K/48p/422/10-I(L)] ⁺		✓	✓	4096×2160	17:9	47.95p	600	AVC
[C4K/48p/422/10-L]		✓	✓	4096×2160	17:9	47.95p	200	AVC
[C4K/48p/420/10-L]		✓	✓	4096×2160	17:9	47.95p	200	HEVC
[C4K/30p/422/10-I]		✓	✓	4096×2160	17:9	29.97p	400	AVC
[C4K/30p/422/10-L]		✓	✓	4096×2160	17:9	29.97p	150	AVC
[C4K/30p/420/10-L]		✓	✓	4096×2160	17:9	29.97p	150	HEVC
[C4K/30p/420/8-L]		✓	✓	4096×2160	17:9	29.97p	100	AVC
[C4K/24p/422/10-I]		✓	✓	4096×2160	17:9	23.98p	400	AVC
[C4K/24p/422/10-L]		✓	✓	4096×2160	17:9	23.98p	150	AVC
[C4K/24p/420/10-L]		✓	✓	4096×2160	17:9	23.98p	150	HEVC
[C4K/24p/420/8-L]		✓	✓	4096×2160	17:9	23.98p	100	AVC
[4K/120p/420/10-L]	✓	✓	✓	3840×2160	16:9	119.88p	300	HEVC
[4K/60p/422/10-I(H)] ⁺		✓	✓	3840×2160	16:9	59.94p	800	AVC
[4K/60p/422/10-I(L)] ⁺		✓	✓	3840×2160	16:9	59.94p	600	AVC
[4K/60p/422/10-L]		✓	✓	3840×2160	16:9	59.94p	200	AVC
[4K/60p/420/10-L]		✓	✓	3840×2160	16:9	59.94p	200	HEVC
[4K/60p/420/8-L]		✓	✓	3840×2160	16:9	59.94p	150	AVC
[4K/48p/422/10-I(H)] ⁺		✓	✓	3840×2160	16:9	47.95p	800	AVC
[4K/48p/422/10-I(L)] ⁺		✓	✓	3840×2160	16:9	47.95p	600	AVC
[4K/48p/422/10-L]		✓	✓	3840×2160	16:9	47.95p	200	AVC
[4K/48p/420/10-L]		✓	✓	3840×2160	16:9	47.95p	200	HEVC
[4K/30p/422/10-I]		✓	✓	3840×2160	16:9	29.97p	400	AVC
[4K/30p/422/10-L]		✓	✓	3840×2160	16:9	29.97p	150	AVC
[4K/30p/420/10-L]		✓	✓	3840×2160	16:9	29.97p	150	HEVC
[4K/30p/420/8-L]		✓	✓	3840×2160	16:9	29.97p	100	AVC
[4K/24p/422/10-I]		✓	✓	3840×2160	16:9	23.98p	400	AVC
[4K/24p/422/10-L]		✓	✓	3840×2160	16:9	23.98p	150	AVC
[4K/24p/420/10-L]		✓	✓	3840×2160	16:9	23.98p	150	HEVC
[4K/24p/420/8-L]		✓	✓	3840×2160	16:9	23.98p	100	AVC

[FHD/240p/422/10-I]	✓	✓		1920×1080	16:9	239.76p	800	AVC
[FHD/240p/422/10-L]	✓	✓		1920×1080	16:9	239.76p	200	AVC
[FHD/240p/420/10-L]	✓	✓		1920×1080	16:9	239.76p	200	HEVC
[FHD/120p/422/10-I]	✓	✓	✓	1920×1080	16:9	119.88p	400	AVC
[FHD/120p/422/10-L]	✓	✓	✓	1920×1080	16:9	119.88p	150	AVC
[FHD/120p/420/10-L]	✓	✓	✓	1920×1080	16:9	119.88p	150	HEVC
[FHD/60p/422/10-I]		✓	✓	1920×1080	16:9	59.94p	200	AVC
[FHD/60p/422/10-L]		✓	✓	1920×1080	16:9	59.94p	100	AVC
[FHD/60p/420/10-L]		✓	✓	1920×1080	16:9	59.94p	100	HEVC
[FHD/60p/420/8-L]		✓	✓	1920×1080	16:9	59.94p	50	AVC
[FHD/60i/422/10-I]		✓	✓	1920×1080	16:9	59.94i	100	AVC
[FHD/60i/422/10-L]		✓	✓	1920×1080	16:9	59.94i	50	AVC
[FHD/48p/422/10-I]		✓	✓	1920×1080	16:9	47.95p	200	AVC
[FHD/48p/422/10-L]		✓	✓	1920×1080	16:9	47.95p	100	AVC
[FHD/48p/420/10-L]		✓	✓	1920×1080	16:9	47.95p	100	HEVC
[FHD/30p/422/10-I]		✓	✓	1920×1080	16:9	29.97p	200	AVC
[FHD/30p/422/10-L]		✓	✓	1920×1080	16:9	29.97p	100	AVC
[FHD/30p/420/10-L]		✓	✓	1920×1080	16:9	29.97p	100	HEVC
[FHD/30p/420/8-L]		✓	✓	1920×1080	16:9	29.97p	25	AVC
[FHD/24p/422/10-I]		✓	✓	1920×1080	16:9	23.98p	200	AVC
[FHD/24p/422/10-L]		✓	✓	1920×1080	16:9	23.98p	100	AVC
[FHD/24p/420/10-L]		✓	✓	1920×1080	16:9	23.98p	100	HEVC
[FHD/24p/420/8-L]		✓	✓	1920×1080	16:9	23.98p	25	AVC

[System Frequency]: [50.00Hz (PAL)]								
[Rec Quality]		[Image Area of Video]		Resolution	Aspect ratio	(A)	(B)	(C)
		FULL	PIXEL PIXEL					
[5.8K/25p/420/10-L]	✓	✓		5760×4320	4:3	25.00p	200	HEVC
[5.7K/50p/420/10-L]	✓	✓		5728×3024	17:9	50.00p	300	HEVC
[5.7K/25p/420/10-L]	✓	✓		5728×3024	17:9	25.00p	200	HEVC
[4.4K/50p/420/10-L]	✓		✓	4352×3264	4:3	50.00p	300	HEVC
[C4K/100p/420/10-L]	✓	✓	✓	4096×2160	17:9	100.00p	300	HEVC
[C4K/50p/422/10-I(H)] ⁺		✓	✓	4096×2160	17:9	50.00p	800	AVC
[C4K/50p/422/10-I(L)] ⁺		✓	✓	4096×2160	17:9	50.00p	600	AVC
[C4K/50p/422/10-L]		✓	✓	4096×2160	17:9	50.00p	200	AVC
[C4K/50p/420/10-L]		✓	✓	4096×2160	17:9	50.00p	200	HEVC
[C4K/50p/420/8-L]		✓	✓	4096×2160	17:9	50.00p	150	AVC
[C4K/25p/422/10-I]		✓	✓	4096×2160	17:9	25.00p	400	AVC
[C4K/25p/422/10-L]		✓	✓	4096×2160	17:9	25.00p	150	AVC
[C4K/25p/420/10-L]		✓	✓	4096×2160	17:9	25.00p	150	HEVC
[C4K/25p/420/8-L]		✓	✓	4096×2160	17:9	25.00p	100	AVC
[4K/100p/420/10-L]	✓	✓	✓	3840×2160	16:9	100.00p	300	HEVC
[4K/50p/422/10-I(H)] ⁺		✓	✓	3840×2160	16:9	50.00p	800	AVC
[4K/50p/422/10-I(L)] ⁺		✓	✓	3840×2160	16:9	50.00p	600	AVC
[4K/50p/422/10-L]		✓	✓	3840×2160	16:9	50.00p	200	AVC
[4K/50p/420/10-L]		✓	✓	3840×2160	16:9	50.00p	200	HEVC
[4K/50p/420/8-L]		✓	✓	3840×2160	16:9	50.00p	150	AVC
[4K/25p/422/10-I]		✓	✓	3840×2160	16:9	25.00p	400	AVC
[4K/25p/422/10-L]		✓	✓	3840×2160	16:9	25.00p	150	AVC
[4K/25p/420/10-L]		✓	✓	3840×2160	16:9	25.00p	150	HEVC
[4K/25p/420/8-L]		✓	✓	3840×2160	16:9	25.00p	100	AVC

[FHD/200p/422/10-I]	✓	✓		1920×1080	16:9	200.00p	800	AVC
[FHD/200p/422/10-L]	✓	✓		1920×1080	16:9	200.00p	200	AVC
[FHD/200p/420/10-L]	✓	✓		1920×1080	16:9	200.00p	200	HEVC
[FHD/100p/422/10-I]	✓	✓	✓	1920×1080	16:9	100.00p	400	AVC
[FHD/100p/422/10-L]	✓	✓	✓	1920×1080	16:9	100.00p	150	AVC
[FHD/100p/420/10-L]	✓	✓	✓	1920×1080	16:9	100.00p	150	HEVC
[FHD/50p/422/10-I]		✓	✓	1920×1080	16:9	50.00p	200	AVC
[FHD/50p/422/10-L]		✓	✓	1920×1080	16:9	50.00p	100	AVC
[FHD/50p/420/10-L]		✓	✓	1920×1080	16:9	50.00p	100	HEVC
[FHD/50p/420/8-L]		✓	✓	1920×1080	16:9	50.00p	50	AVC
[FHD/50i/422/10-I]		✓	✓	1920×1080	16:9	50.00i	100	AVC
[FHD/50i/422/10-L]		✓	✓	1920×1080	16:9	50.00i	50	AVC
[FHD/25p/422/10-I]		✓	✓	1920×1080	16:9	25.00p	200	AVC
[FHD/25p/422/10-L]		✓	✓	1920×1080	16:9	25.00p	100	AVC
[FHD/25p/420/10-L]		✓	✓	1920×1080	16:9	25.00p	100	HEVC
[FHD/25p/420/8-L]		✓	✓	1920×1080	16:9	25.00p	25	AVC

[System Frequency]: [24.00Hz (CINEMA)]								
[Rec Quality]		[Image Area of Video]		Resolution	Aspect ratio	(A)	(B)	(C)
		FULL	PIXEL PIXEL					
[5.8K/24p/420/10-L]	✓	✓		5760×4320	4:3	24.00p	200	HEVC
[5.7K/48p/420/10-L]	✓	✓		5728×3024	17:9	48.00p	300	HEVC
[5.7K/24p/420/10-L]	✓	✓		5728×3024	17:9	24.00p	200	HEVC
[4.4K/48p/420/10-L]	✓		✓	4352×3264	4:3	48.00p	300	HEVC
[C4K/120p/420/10-L]	✓	✓	✓	4096×2160	17:9	120.00p	300	HEVC
[C4K/24p/422/10-I]		✓	✓	4096×2160	17:9	24.00p	400	AVC
[C4K/24p/422/10-L]		✓	✓	4096×2160	17:9	24.00p	150	AVC
[C4K/24p/420/10-L]		✓	✓	4096×2160	17:9	24.00p	150	HEVC
[C4K/24p/420/8-L]		✓	✓	4096×2160	17:9	24.00p	100	AVC
[4K/120p/420/10-L]	✓	✓	✓	3840×2160	16:9	120.00p	300	HEVC
[4K/24p/422/10-I]		✓	✓	3840×2160	16:9	24.00p	400	AVC
[4K/24p/422/10-L]		✓	✓	3840×2160	16:9	24.00p	150	AVC
[4K/24p/420/10-L]		✓	✓	3840×2160	16:9	24.00p	150	HEVC
[4K/24p/420/8-L]		✓	✓	3840×2160	16:9	24.00p	100	AVC
[FHD/120p/422/10-I]	✓	✓	✓	1920×1080	16:9	120.00p	400	AVC
[FHD/120p/422/10-L]	✓	✓	✓	1920×1080	16:9	120.00p	150	AVC
[FHD/120p/420/10-L]	✓	✓	✓	1920×1080	16:9	120.00p	150	HEVC
[FHD/24p/422/10-I]		✓	✓	1920×1080	16:9	24.00p	200	AVC
[FHD/24p/422/10-L]		✓	✓	1920×1080	16:9	24.00p	100	AVC
[FHD/24p/420/10-L]		✓	✓	1920×1080	16:9	24.00p	100	HEVC
[FHD/24p/420/8-L]		✓	✓	1920×1080	16:9	24.00p	25	AVC

* [Rec Quality] [(H)] indicates a bit rate of 800 Mbps and [(L)] indicates a bit rate of 600 Mbps.

[(H)] video cannot be recorded to SD cards.

❖ [Rec. File Format]: [Apple ProRes]

- Audio format: LPCM (2ch/4ch)

4-channel audio can be recorded when the XLR Microphone Adaptor (DMW-XLR2: optional) is connected by setting [4ch Audio Recording] to [XLR] or [XLR+CAMERA].

 M: Only available in Creative Video mode.

(A) Recording frame rate

(B) Bit rate

(C) Video compression format (**RAW HQ**: Apple ProRes RAW HQ, **RAW**: Apple ProRes RAW, **422 HQ**: Apple ProRes 422 HQ, **422**: Apple ProRes 422)

[System Frequency]: [59.94Hz (NTSC)]								
[Rec Quality]	 M	[Image Area of Video]		Resolution	Aspect ratio	(A)	(B)	(C)
		FULL	PIXEL PIXEL					
[5.7K/30p/RAW HQ]	✓	✓		5728×3024	17:9	29.97p	4.2 Gbps	RAW HQ
[5.7K/30p/RAW]	✓	✓		5728×3024	17:9	29.97p	2.8 Gbps	RAW
[5.7K/30p/422 HQ]	✓	✓		5728×3024	17:9	29.97p	1.9 Gbps	422 HQ
[5.7K/30p/422]	✓	✓		5728×3024	17:9	29.97p	1.3 Gbps	422
[5.7K/24p/RAW HQ]	✓	✓		5728×3024	17:9	23.98p	3.3 Gbps	RAW HQ
[5.7K/24p/RAW]	✓	✓		5728×3024	17:9	23.98p	2.2 Gbps	RAW
[5.7K/24p/422 HQ]	✓	✓		5728×3024	17:9	23.98p	1.5 Gbps	422 HQ
[5.7K/24p/422]	✓	✓		5728×3024	17:9	23.98p	1.0 Gbps	422
[C4K/60p/RAW HQ]	✓		✓	4096×2160	17:9	59.94p	4.2 Gbps	RAW HQ
[C4K/60p/RAW]	✓		✓	4096×2160	17:9	59.94p	2.8 Gbps	RAW
[C4K/60p/422 HQ]		✓	✓	4096×2160	17:9	59.94p	1.9 Gbps	422 HQ
[C4K/60p/422]		✓	✓	4096×2160	17:9	59.94p	1.3 Gbps	422

[C4K/30p/RAW HQ]	✓		✓	4096×2160	17:9	29.97p	2.1 Gbps	RAW HQ
[C4K/30p/RAW]	✓		✓	4096×2160	17:9	29.97p	1.4 Gbps	RAW
[C4K/30p/422 HQ]		✓	✓	4096×2160	17:9	29.97p	972 Mbps	422 HQ
[C4K/30p/422]		✓	✓	4096×2160	17:9	29.97p	648 Mbps	422
[C4K/24p/RAW HQ]	✓		✓	4096×2160	17:9	23.98p	1.7 Gbps	RAW HQ
[C4K/24p/RAW]	✓		✓	4096×2160	17:9	23.98p	1.1 Gbps	RAW
[C4K/24p/422 HQ]		✓	✓	4096×2160	17:9	23.98p	778 Mbps	422 HQ
[C4K/24p/422]		✓	✓	4096×2160	17:9	23.98p	519 Mbps	422
[FHD/60p/422 HQ]		✓	✓	1920×1080	16:9	59.94p	454 Mbps	422 HQ
[FHD/60p/422]		✓	✓	1920×1080	16:9	59.94p	302 Mbps	422
[FHD/30p/422 HQ]		✓	✓	1920×1080	16:9	29.97p	227 Mbps	422 HQ
[FHD/30p/422]		✓	✓	1920×1080	16:9	29.97p	151 Mbps	422
[FHD/24p/422 HQ]		✓	✓	1920×1080	16:9	23.98p	181 Mbps	422 HQ
[FHD/24p/422]		✓	✓	1920×1080	16:9	23.98p	121 Mbps	422

[System Frequency]: [50.00Hz (PAL)]								
[Rec Quality]		[Image Area of Video]		Resolution	Aspect ratio	(A)	(B)	(C)
		FULL	PIXEL PIXEL					
[5.7K/25p/RAW HQ]	✓	✓		5728×3024	17:9	25.00p	3.5 Gbps	RAW HQ
[5.7K/25p/RAW]	✓	✓		5728×3024	17:9	25.00p	2.3 Gbps	RAW
[5.7K/25p/422 HQ]	✓	✓		5728×3024	17:9	25.00p	1.6 Gbps	422 HQ
[5.7K/25p/422]	✓	✓		5728×3024	17:9	25.00p	1.1 Gbps	422
[C4K/50p/RAW HQ]	✓		✓	4096×2160	17:9	50.00p	3.5 Gbps	RAW HQ
[C4K/50p/RAW]	✓		✓	4096×2160	17:9	50.00p	2.4 Gbps	RAW
[C4K/50p/422 HQ]		✓	✓	4096×2160	17:9	50.00p	1.6 Gbps	422 HQ
[C4K/50p/422]		✓	✓	4096×2160	17:9	50.00p	1.1 Gbps	422
[C4K/25p/RAW HQ]	✓		✓	4096×2160	17:9	25.00p	1.8 Gbps	RAW HQ
[C4K/25p/RAW]	✓		✓	4096×2160	17:9	25.00p	1.2 Gbps	RAW
[C4K/25p/422 HQ]		✓	✓	4096×2160	17:9	25.00p	811 Mbps	422 HQ
[C4K/25p/422]		✓	✓	4096×2160	17:9	25.00p	541 Mbps	422
[FHD/50p/422 HQ]		✓	✓	1920×1080	16:9	50.00p	378 Mbps	422 HQ
[FHD/50p/422]		✓	✓	1920×1080	16:9	50.00p	252 Mbps	422
[FHD/25p/422 HQ]		✓	✓	1920×1080	16:9	25.00p	189 Mbps	422 HQ
[FHD/25p/422]		✓	✓	1920×1080	16:9	25.00p	126 Mbps	422

[System Frequency]: [24.00Hz (CINEMA)]								
[Rec Quality]		[Image Area of Video]		Resolution	Aspect ratio	(A)	(B)	(C)
		FULL	PIXEL PIXEL					
[5.7K/24p/RAW HQ]	✓	✓		5728×3024	17:9	24.00p	3.3 Gbps	RAW HQ
[5.7K/24p/RAW]	✓	✓		5728×3024	17:9	24.00p	2.2 Gbps	RAW
[5.7K/24p/422 HQ]	✓	✓		5728×3024	17:9	24.00p	1.5 Gbps	422 HQ
[5.7K/24p/422]	✓	✓		5728×3024	17:9	24.00p	1.0 Gbps	422
[C4K/24p/RAW HQ]	✓		✓	4096×2160	17:9	24.00p	1.7 Gbps	RAW HQ
[C4K/24p/RAW]	✓		✓	4096×2160	17:9	24.00p	1.1 Gbps	RAW
[C4K/24p/422 HQ]		✓	✓	4096×2160	17:9	24.00p	779 Mbps	422 HQ
[C4K/24p/422]		✓	✓	4096×2160	17:9	24.00p	519 Mbps	422
[FHD/24p/422 HQ]		✓	✓	1920×1080	16:9	24.00p	182 Mbps	422 HQ
[FHD/24p/422]		✓	✓	1920×1080	16:9	24.00p	121 Mbps	422

- In this document, videos are indicated as follows according to their resolution:
 - 5.8K (5760×4320) video: **5.8K video**
 - 5.7K (5728×3024) video: **5.7K video**
 - 4.4K (4352×3264) video: **4.4K video**
 - C4K (4096×2160) video: **C4K video**
 - 4K (3840×2160) video: **4K video**
 - Full High Definition (1920×1080) video: **FHD video**



- Since the camera employs the VBR recording format, the bit rate is changed automatically depending on the subject to record. As a result, video recording time is shortened when a fast-moving subject is recorded.
- Videos in ALL-Intra and 4:2:2 10-bit formats and videos whose [Rec. File Format] is [Apple ProRes] are intended for editing on a PC used for video production.



- You can register a combination of [System Frequency], [Rec. File Format], [Image Area of Video], and [Rec Quality] to My List. (➔ [\[add to list\]: 157](#))

❖ [Filtering]

When [Rec. File Format] is set to [MOV] or [Apple ProRes], you can specify items such as frame rate, number of pixels (resolution), and compression format (YUV, bit value, image compression), and just display recording qualities that meet those conditions.

- 1 In the [Rec Quality] setting screen, press [DISP.].



- 2 Press ▲▼ to select a setting item and then press or .
 - Settings: [Frame Rate]/[Resolution]/[Codec]/[Variable Frame Rate]/[Hybrid Log Gamma]/[Proxy Recording]
- 3 Press ▲▼ to select the filtering conditions and then press or .
- 4 Press [DISP.] to confirm the setting.
 - You are returned to the [Rec Quality] setting screen.

Clearing the filtering conditions

Select [ANY] in Step 3.

- The filtering conditions are also cleared when you do the following:
 - Change the [Rec. File Format]
 - Change the [System Frequency]
 - Select a recording quality from [Rec Quality (My List)]



- When you change recording quality using a filter, the current filtering conditions are stored.

❖ [add to list]





Select a recording quality and register it in My List. The recording quality you register can be set in [Rec Quality (My List)].

In the [Rec Quality] setting screen, press [Q].

- The following settings are also registered at the same time:
 - [System Frequency]
 - [Rec. File Format]
 - [Image Area of Video]



Setting or deleting in My List

- 1 Select [Rec Quality (My List)].
 -  ⇒  ⇒  ⇒ [Rec Quality (My List)]
- 2 Press ▲▼ to select a setting item and then press  or  .
 - You cannot select setting items that have different system frequencies.
 - To delete from My List, select the item and press [Q].

Setting from the control panel

It is possible to display the My List of recording qualities from the control panel in [P/M] mode or when [Video-Priority Display] is set.

Touch the recording quality item.

- When already registered in My List, the [Rec Quality (My List)] setting screen is displayed.
When not yet registered, the [Rec Quality] setting screen is displayed.
- [Rec Quality (My List)] and [Rec Quality] switch each time you press the [DISP.] button.
- The next time the setting screen is displayed, the screen last used is displayed.

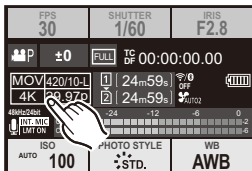

- Up to 12 types of recording quality can be registered.

RAW Video Recording



High bit rate RAW video (ProRes RAW HQ/ProRes RAW formats) can be recorded onto the camera. (Cannot be recorded to SD cards)

1 Set the recording mode to [M].

- Set the mode dial. (→ [Selecting the Recording Mode: 82](#))

2 Set [Rec. File Format] to [Apple ProRes].

- → [] → [] → [Rec. File Format] → [Apple ProRes]

3 Set to a recording quality that enables RAW video recording.

- → [] → [] → [Rec Quality]
- Select the [Apple ProRes RAW HQ] or [Apple ProRes RAW] recording quality and press or .





• Notes about RAW Video

RAW video refers to a data format of images that have not been processed on the camera. You will need compatible software to play or edit RAW video on devices other than this camera.



- Operation is as follows when recording RAW video:
 - ISO sensitivity can be set in the range between 500 and 51200. You can set between 125 and 51200 when [Extended ISO] is set.
 - [AWB], [AWBc], [AWBw] and [$\frac{1}{2}$ WB] cannot be used for white balance.
 - [Photo Style] is fixed to [V-Log], and Image quality cannot be adjusted.
 - [.....]/[+] of the AF mode is not available.
 - The LUT used by [Log View Assist] is fixed to [Vlog_709].
- When recording RAW video, the following functions are not available:
 - [Master Pedestal Level]
 - [i.Dynamic Range]
 - [Vignetting Comp.]
 - [Diffraction Compensation]
 - [Filter Settings]
 - [Variable Frame Rate]
 - [Luminance Level]
 - [E-Stabilization (Video)] ([Image Stabilizer])
 - [Loop Recording (video)]
 - [Segmented File Recording]
 - [Live Cropping]
 - [Color Space]
 - [Color Bars]
 - [Double Card Slot Function]
- The compatible software supports only V-Log/V-Gamut conversion.

Proxy Recording



iA P A S M

During video recording, a proxy video with a low bit rate can also be recorded simultaneously.

The size is small so it is suitable for data transmission, such as uploading to the cloud. It is also less demanding on your PC during editing.

1 Set [Rec. File Format] to [MOV] or [Apple ProRes].

- → → → [Rec. File Format]

2 Select a recording quality with which you can record proxy video.



- → → → [Rec Quality]
- Items available for recording with proxy video are indicated as [Proxy available].



3 Make proxy recording settings.

-  ⇒  ⇒  ⇒ [Proxy Recording Settings] ⇒ [Proxy Recording] ⇒ [ON]



- The original video set in [Rec Quality] is recorded to card slot 1 and the proxy video is recorded to card slot 2.
- During playback, the original video is indicated with  and the proxy video is indicated with .



- You cannot change the recording destination for proxy videos.
- [Proxy Recording] is not available if a card is not inserted in one of the recording destinations.
- When [USB-SSD] is set to [ON], the original video is recorded to the external SSD. Set [USB-SSD] to [OFF] to play back the proxy video.
- If a lack of space on a card, etc., causes recording of the original video to stop after recording has started, [Proxy Recording] also stops. If recording of the proxy video stops first, recording of the original video continues.
- [Proxy Recording] is not available with the following recording media combinations:
 - SD/SDHC memory cards and CFexpress cards
 - SD/SDHC memory cards and external SSDs
- When the following functions are being used, [Proxy Recording] is not available:
 - [MP4] ([Rec. File Format])
 - [Rec Quality] exceeding a resolution of C4K
 - [Rec Quality] with [4:3] or [3:2] aspect ratio
 - [Rec Quality] with a recording frame rate of [59.94i] or [50.00i]
 - [Rec Quality] with a high frame rate video
 - [HDMI RAW Data Output]
 - [Streaming]
- The following functions are not available when recording proxy video:
 - Fn buttons registered with [Photo Style], [Apply LUT] and [REAL TIME LUT]

❖ Setting the Proxy Recording Quality

 →  →  → **[Proxy Recording Settings]** → **Select [Proxy Rec. Quality]**

(A) Video compression format (HEVC: H.265/HEVC, AVC: H.264/MPEG-4 AVC)

[Proxy Rec. Quality]	Resolution	YUV, Bit value	Bit rate (Mbps)					(A)
			60p	50p	30p	25p	24p	
[H]	1980×1080	4:2:0 10bit	16	16	12	12	12	HEVC
[M]	1980×1080	4:2:0 10bit	9	9	6	6	6	HEVC
[L]	1280×720	4:2:0 8bit	6	6	4	4	4	AVC

- The bit rate (Mbps) is a value for the images only. There is variation depending on the audio recorded.
- The frame rate is the same as the original video.
- The aspect ratio is fixed to [16:9]. When the original video is [17:9], black bands are added to the top and bottom of the screen.
- Audio is fixed to LPCM, 48 kHz/16 bit. The number of channels is the same as the original video.
- When [Photo Style] is [ARRI LogC3], [L] in [Proxy Rec. Quality] is not available.

❖ Save Destination for Proxy Videos

Proxy videos are saved to the [xxx_PRXY] folder in card slot 2.

When the [Video File Name] is [CINE Style], a folder is created in card slot 2 that has the same folder number as the folder in which the original video is saved, with the end changed to an “S” and proxy videos are saved there.

- The proxy video file name is the same as the original video.

❖ Applying LUT Files to Proxy Videos

This can be set when [Photo Style] is [REAL TIME LUT] or My Photo Style.

 ➔  ➔  ➔ **[Proxy Recording Settings] ➔ Select [Real Time LUT(Proxy)]**

Settings: [ON]/[OFF]

- When [Photo Style] is [REAL TIME LUT] or if a LUT file is applied in My Photo Style, this is fixed to [ON].



- LUT cannot be applied to only proxy video when using the following functions:
 - [Crop Zoom(Video)]
 - [Live Cropping]

[Image Area of Video]



Set the image area during video recording. The angle of view differs depending on the image area. Narrowing the image area allows you to achieve a telescopic effect without image deterioration.

MENU / SET → **[👤]** → **[🎬]** → **Select [Image Area of Video]**



[FULL]

Records according to the range that corresponds to the image circle of the lens that is for Micro Four Thirds.

[PIXEL/PIXEL]

Records with one pixel on the sensor, which is equal to one pixel of the video.

Records a range corresponding to the resolution range in [Rec Quality]. (→[Rec Quality]: 142)

- The [Image Area of Video] settings you can select differ depending on the [Rec Quality] setting. (→[Rec Quality]: 142)

Image area (Ex.: FHD video)

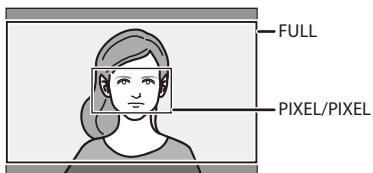

FULL



PIXEL/PIXEL

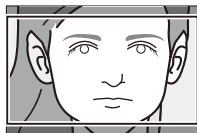

(A) Angle of view: Wide/Telescopic effect: Not possible

(B) Angle of view: Narrow/Telescopic effect: Possible

Focus / Zoom

Smoother focusing is possible by selecting the focus mode and AF mode most suited to the recording conditions and the subject.

- This camera supports phase detection AF and contrast AF.

- [Selecting the Focus Mode: 169](#)
- [Using AF: 171](#)
- [Selecting the AF Mode: 189](#)
- [AF Area Operations: 206](#)
- [Record Using MF: 215](#)
- [Recording with Zoom: 222](#)

Selecting the Focus Mode



Select the focusing method (focus mode) to match subject movement.

It is also possible to customize the AF tracking features with [AFC]. (→ [\[AF Custom Setting\(Photo\)\]: 178](#))

Set the focus mode lever.

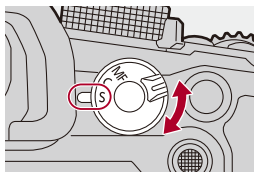

[S] ([AFS])

This is suitable for recording still subjects.

When the shutter button is pressed halfway, the camera focuses once.

The focus stays locked while the shutter button is pressed halfway.

[C] ([AFC])

This is suitable for recording moving subjects.

While the shutter button is pressed halfway, the focus is constantly adjusted according to the movement of the subject.

- This predicts the movement of the subject, maintaining focusing. (Movement prediction)
-

[MF]

Manual focusing. Use this when you want to fix the focus or avoid activating AF.

(→ [Record Using MF: 215](#))



- In the following cases, [AFC] works the same as [AFS] when the shutter button is pressed halfway:
 - [pM] mode
 - During video recording
 - In low light situations
- When the following function is being used, [AFC] switches to [AFS]:
 - High Resolution mode

Using AF

- [AF-Point Scope]: 176
- [AF Custom Setting(Photo)]: 178
- [Focus Limiter]: 181
- [AF Assist Light]: 183
- [Focus Frame Moving Speed]: 184
- [AF Micro Adjustment]: 185









AF (Auto Focus) refers to automatic focusing.

Select the focus mode and the AF mode appropriate for the subject and scene.

1 Set the focus mode to [AFS] or [AFC].

- Set the focus mode lever. (→ [Selecting the Focus Mode: 169](#))

2 Select the AF mode.

- Press [] to display the AF mode selection screen, and set using  or . (→ [Selecting the AF Mode: 189](#))
- In [iA] mode, each press of [] switches between [] and []. (→ [AF Mode: 113](#))

3 Press the shutter button halfway.

- The AF operates.

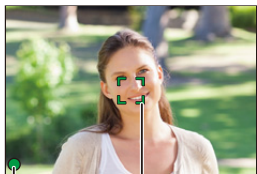

(A)

(B)

	Focus	
	In focus	Not in focus
Focus icon (A)	Lights	Blinking
AF area (B)	Green	Red
AF beep	Two beeps	—

Low illumination AF

- In dark environments, low illumination AF automatically operates, and the focus icon is indicated as [].
- Achieving focus may take more time than usual.

Starlight AF

- If the camera detects stars in the night sky after determining low illumination AF, then Starlight AF will be activated.

When focus is achieved, the focus icon will display [], and the AF area will be displayed on the area in focus.

- Edges of the screen cannot detect Starlight AF.

❖ [AF ON] button

You can also activate AF by pressing [AF ON].

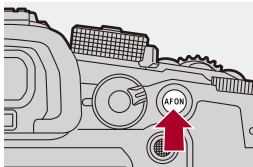



• **Subjects and recording conditions that make focusing difficult with AF mode**

- Fast-moving subjects
- Extremely bright subjects
- Subjects without contrast
- Subjects recorded through windows
- Subjects near shiny objects
- Subjects in very dark locations
- When recording subjects both distant and near



- When the following operations are performed while recording with [AFC], it may take some time for the camera to focus:
 - When zooming from the wide-angle end to the telephoto end
 - When the subject is suddenly changed from one far away to one close by
- If using the zoom after achieving focus, the focus may be erroneous. In that case, re-adjust the focus.



- You can restrict the range for AF to work:
(→[Focus Limiter]: 181)
- When camera shake reduces, it is possible to focus automatically:
(→[Quick AF]: 638)
- You can change the settings so that AF does not function when the shutter button is pressed halfway:
(→[Half-Press Shutter]: 638)
- The AF beep volume and sound can be changed:
(→[Beep]: 683)
- You can assign the function that makes AF work so that it prioritizes subjects close by to an Fn button.
This function is useful when the camera mistakenly focuses on the background:
(→[AF-ON : Near Shift]: 604)
- You can assign the function that makes AF work so that it prioritizes subjects far away to an Fn button.
This function is useful when taking pictures through fences or nets:
(→[AF-ON : Far Shift]: 604)

[AF-Point Scope]



This magnifies the focus point when the AF mode is [], [], or []. (In other AF modes, the center of the screen is magnified.)

You can check focus and observe an enlarged subject as with a telephoto lens.

1 Register [AF-Point Scope] to the Fn button. (→ [Fn Buttons: 597](#))

2 Enlarge display.

- Press the Fn button set in Step 1.
- While pressing the button, the focus point is enlarged.

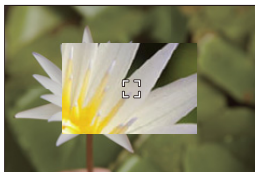

- When the screen is enlarged, pressing the shutter button halfway re-acquires focus in a small central AF area.
- When the screen is enlarged, turn or to adjust the magnification.
- Use for more detailed adjustments.



- When the screen is enlarged, [AFC] changes to [AFS].
- When the following function is being used, AF-Point Scope does not work:
 - Video recording/SH burst recording



- You can change the display method of the magnified screen:
(→ [\[AF-Point Scope Setting\]: 637](#))

[AF Custom Setting(Photo)]



You can select features of AF operation when taking pictures with [AFC] that are appropriate for the subject and scene.

Each of these features can be further customized.

1 Set the focus mode to [AFC].

- Set the focus mode lever. (→ [Selecting the Focus Mode: 169](#))

2 Set [AF Custom Setting(Photo)].

- → → → [AF Custom Setting(Photo)]

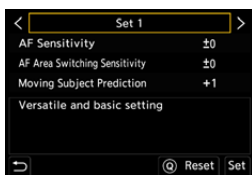

[Set 1]

Basic general-purpose setting.

[Set 2]

Suggested for situations where the subject moves at a constant speed in one direction.



[Set 3]

Suggested when the subject moves randomly, and other objects may be in the scene.

[Set 4]

Suggested for situations where the speed of the subject changes significantly.

❖ Adjusting AF Custom Settings

- 1 Press ◀▶ to select the AF Custom setting type.
- 2 Press ▲▼ to select items and press ◀▶ to adjust.
 - A description of the item is displayed on the screen when you press [DISP].
 - To reset settings to the default, press [Q].
- 3 Press  or .

[AF Sensitivity]		Sets the tracking sensitivity for the movement of subjects.
	[+]	When the distance to the subject changes drastically, the camera re-adjusts the focus immediately. You can bring different subjects into focus one after another.
	[-]	When the distance to the subject changes drastically, the camera waits for a short period of time before re-adjusting the focus. This allows you to prevent the focus from being accidentally re-adjusted when, for example, an object moves across the image.
[AF Area Switching Sensitivity]		Sets the sensitivity for switching the AF area to match subject movement. (When AF mode is set to Full Area AF)
	[+]	When the subject moves out of the AF area, the camera immediately switches the AF area to keep the subject in focus.
	[-]	The camera switches the AF area at a gradual pace. Effects caused by a slight movement of the subject or by obstacles in front of the camera will be minimized.

[Moving Subject Prediction]	Sets the tracking method for changes in the speed of subject movement.	
	• At larger setting values, the camera tries to maintain focus by responding even to sudden movements of the subject. However, the camera becomes more sensitive to slight movements of the subject, so focusing may become unstable.	
	[0]	This is suited to a subject with minimal changes in speed.
	[+1] [+2]	These are suited to a subject that changes its speed.

[Focus Limiter]



You can restrict the range for AF to work.

The focusing speed of AF increases when you limit the range where AF works.

1 Set the focus mode to [AFS] or [AFC].

- Set the focus mode lever. (→ [Selecting the Focus Mode: 169](#))

2 Set [Focus Limiter].

- → []/[] → [] → [Focus Limiter]

[ON]

Enables the following settings.



[OFF]

Disables the following settings.

[SET]

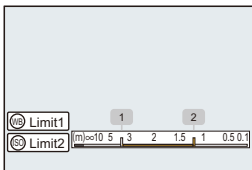
- 1 Use the same procedure as MF (→ [Record Using MF: 215](#)) to check the focus, then press [WB] or [ISO] to set the range of operation for AF.
 - This can also be set by touching [Limit1]/[Limit2].
 - [Limit1]/[Limit2] can be set from either.



- 2 Press  or  to confirm the setting.
 - Press [DISP.] to return the operation range to the default setting.



- This can be set when using a lens with a focus ring or a focus lever.
- It cannot be set if the focusing distance range selector switch of the lens has been used to limit the operation range.
- The setting values are reset when the lens is replaced.
- When [Focus Limiter] is working, [A_{11}^F]/[A_{12}^F] is displayed on the screen.
- When the following function is being used, [Focus Limiter] is not available:
 - [AF+MF]

[AF Assist Light]



When recording in low light conditions, the AF assist light turns on when you press the shutter button halfway, making it easier for the camera to focus.

MENU/SET → **[CAMERA]/[VIDEO]** → **[FOCUS]** → **Select [AF Assist Light]**

Settings: [ON]/[OFF]

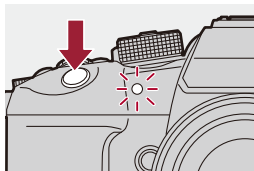

- The effective range of the AF assist light is different depending on the lens used.
 - When the interchangeable lens (H-ES12060) is attached and at wide-angle end.
Approx. 1.0 m (3.3 feet) to 3.5 m (11 feet)
 - When the interchangeable lens (H-FS12060) is attached and at wide-angle end.
Approx. 1.0 m (3.3 feet) to 3.0 m (9.8 feet)
- Remove the lens hood.
- The AF assist light may be greatly blocked, and it may become harder to focus when a lens with large diameter is used.

[Focus Frame Moving Speed]



Sets the speed when moving the AF area/MF Assist.

 →  /  →  → **Select [Focus Frame Moving Speed]**

Settings: [FAST]/[NORMAL]

[AF Micro Adjustment]



You can make fine adjustments to the focus point when focusing with phase detection AF.



- There is normally no need to adjust the focus point. Adjust only when necessary. If you adjust on a lens that has a correct focus point, there is a risk that the camera will not be able to record with the appropriate focus point.

 → [] → [] → **Select [AF Micro Adjustment]**

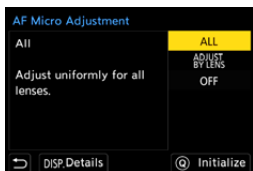

[ALL]

Adjust uniformly for all lenses.

Used in cases such as when you have attached lenses that are not registered in [ADJUST BY LENS].



[ADJUST BY LENS]

Adjust each lens separately and register the adjustment values on the camera. When a registered lens is attached, the adjusted value is recalled when it is set in [ADJUST BY LENS].





- When using a zoom lens, you can adjust the focus point individually at the wide-angle end and the telephoto end.
 - If the lens has already been registered, the adjustment value is overwritten.
-

[OFF]

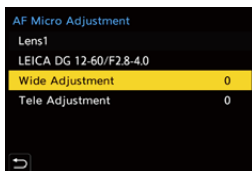
❖ Registering the Adjusted Value

- 1 Select [ALL] or [ADJUST BY LENS] and then press [DISP.].
- 2 (When [ADJUST BY LENS] is selected) Register the lens.
 - Press [DISP.] and select [Yes] to register.
 - If the lens is already registered, the screen moves to the one in Step 3.
- 3 (When [ADJUST BY LENS] is selected) Select [Wide Adjustment] or [Tele Adjustment].
 - Press ▲▼ to select, and then press  or .
 - When using a prime lens, [Adjustment] is displayed.



- 4 Adjust the focus point.
 - Press ◀▶ to adjust the focus point and then press  or .
 - You can also adjust by rotating , , or .
 - The focus point is moved backward when adjusted with the [+] side. The focus point is moved forward when adjusted with the [-] side.

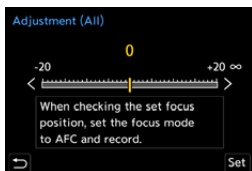

- 5 Record and repeat Step 4 until the suitable focus point is reached.
 - Check the set focus point in an image recorded with [AFC] of the [Focus/Shutter Priority] set to [FOCUS] and with the focus mode set to [AFC].
(→ [Focus/Shutter Priority]: 634)



- We recommend making the adjustments in the same environment that will be used for recording.
- We recommend using a tripod when adjusting.



- You can register a maximum of 40 lenses in [ADJUST BY LENS]. When the upper limit is exceeded, already registered lens information is overwritten.
- When a teleconverter is used when adjusted with [ADJUST BY LENS], the combination of the lens and teleconverter is registered.
- The focus point for the wide-angle end and the telephoto end cannot be individually adjusted in [ALL].
- The registration numbers and lens names registered in [ADJUST BY LENS] are entered automatically and cannot be changed.

❖ Initializing

Registered lens information and adjusted values are initialized.

- 1 Select [ALL] or [ADJUST BY LENS] and then press [Q].
- 2 Select [Yes] to initialize.



- Irrespective of the [ALL]/[ADJUST BY LENS] selection, all of the registered lens information and adjusted values in [AF Micro Adjustment] are initialized.

Selecting the AF Mode

- Automatic Detection: 192
- [Tracking]: 196
- [Full Area AF]: 197
- [Zone(Horizontal/Vertical)]/[Zone]: 200
- [1-Area+]/[1-Area]: 202
- [Pinpoint]: 204





Select the focusing method to match the position and number of subjects. In an AF mode other than Pinpoint, you can automatically focus by detecting subjects.

1 Press [].

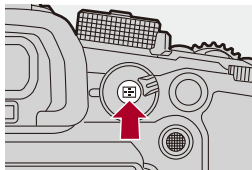
- The AF mode selection screen appears.



2 Select the AF mode.

- Press ◀▶ to select an item and then press  or .
- Selection is also possible by pressing [].

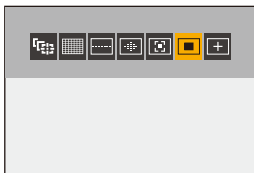

 [Tracking]

(→[Tracking]: 196)

 [Full Area AF]

(→[Full Area AF]: 197)

 [Zone(Horizontal/Vertical)]

(→[Zone(Horizontal/Vertical)]: 200)

 [Zone]

(→[Zone]: 201)

 [1-Area+]

(→[1-Area+]: 202)



 [1-Area]

(→[1-Area]: 202)

 [Pinpoint]

(→[Pinpoint]: 204)



- When the following functions are being used, [] is not available:
 - [Time Lapse Shot]
 - [Live View Composite]
- When the focus mode is set to [AFC], [] is not available.
- When the following function is being used, the AF mode is fixed to []:
 - [Live Cropping]



- You can set the AF mode items to be displayed on the AF mode selection screen:

(→ [\[Show/Hide AF Mode\]: 636](#))

Automatic Detection

When automatic detection is enabled, subjects for recording are automatically detected and the camera focuses.



- Not all subjects can be detected according to the settings.
- When [Detecting Subject] ([Type of Subject]) is [ANIMAL], some subjects that are not animals may be detected as animals.

1 Set [AF Detection Setting] to [ON].

•  → []/[] → [] → [AF Detection Setting] → [ON]

- You can also press ▲ in the AF mode selection screen to switch automatic detection [ON]/[OFF].

2 Select [Detecting Subject].

•  → []/[] → [] → [Detecting Subject]

- Select [Type of Subject] and [Target Parts].
- It is also possible to select by pressing [DISP.] in the AF mode selection screen.

[Type of Subject]	[HUMAN]	<p>Detects humans.</p> <p>Select either [Eye/Face/Body] or [Eye/Face] for the [Target Parts].</p> <ul style="list-style-type: none"> • [👤] or [👁️] is displayed on the AF mode icon.
	[ANIMAL]	<p>Detects animals.</p> <p>Select either [Body] or [Eye/Body] for the [Target Parts].</p> <ul style="list-style-type: none"> • Animals that can be detected are birds, canines (including wolves, etc.), and felines (including lions, etc.). • [🐾] or [🐾] is displayed on the AF mode icon.
	[CAR]	<p>Detects cars (mainly for motor sports).</p> <p>Select either [Entire Subject] or [Main Part Priority] for the [Target Parts].</p> <ul style="list-style-type: none"> • [🚗] or [🏎️] is displayed on the AF mode icon.
	[MOTORCYCLE]	<p>Detects motorcycles (mainly for motor sports).</p> <p>Select either [Entire Subject] or [Helmet Priority] for the [Target Parts].</p> <ul style="list-style-type: none"> • [🏍️] or [🏍️] is displayed on the AF mode icon.
	[TRAIN]	<p>Detects railroad cars.</p> <p>Select either [First Car] or [Main Part Priority] for the [Target Parts].</p> <ul style="list-style-type: none"> • [🚆] or [🚆] is displayed on the AF mode icon.
	[AIRPLANE]	<p>Detects aircraft and helicopters.</p> <p>Select either [Airframe] or [Nose Priority] for the [Target Parts].</p> <ul style="list-style-type: none"> • [✈️] or [✈️] is displayed on the AF mode icon.
[Target Parts]	<p>Select the part to be brought into focus.</p> <p>The parts you can select depend on the [Type of Subject] setting.</p>	

❖ When []

When a subject to be recorded is detected, an AF area is displayed. If multiple subjects are detected, multiple AF areas are also displayed, and you can select the subject you want to focus on from amongst these.

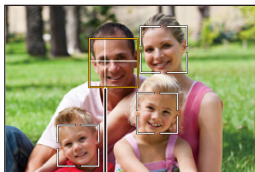

(A)

Yellow

AF area to be brought into focus.

The camera selects this automatically.

- A cross appears in the AF area when a human eye is detected. (A)

White

Displayed when multiple subjects are detected.

❖ When [⌂], [⋮], [⌂], [⌂], or [⌂]

If even part of a subject to be recorded enters the AF area, it is automatically detected and focused.

- If eyes are detected inside the AF area, eye detection (B) works.
It is not possible to change the eye to focus on.

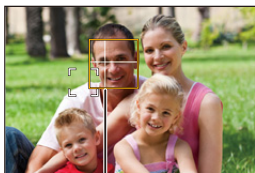

(B)



- [AF Detection Setting] is applied to all AF modes excluding [⊕].
- When a person's eyes are detected, the eye closer to the camera will be brought into focus.

The exposure will be adjusted to the face. (When [Metering Mode] is set to [⊙])

- Depending on [Detecting Subject], the number of subjects that can be detected at once with [⌂] of the AF mode will be different.

[HUMAN] ([Eye/Face/Body], [Eye/Face]): Maximum 15 (maximum 3 bodies detected)

[ANIMAL] ([Body]), [CAR], [MOTORCYCLE], [TRAIN], [AIRPLANE]: Maximum 3

[ANIMAL] ([Eye/Body]): Maximum 1

- Automatic detection may not be available due to the camera settings.



- You can make it so the metering range for automatic exposure is not prioritized on the eyes and face when automatic detection works:
(→[Face Priority In Multi Metering]: 630)
- The cross that appears on human eyes when focused can be made to disappear:
(→[Human Eye Detection Display]: 638)

[Tracking]

When the focus mode is set to [AFC], the AF area follows the movement of the subject, maintaining focusing.

Start tracking.

- Aim the AF area over the subject, and press the shutter button halfway. The camera will track the subject while the shutter button is pressed halfway or pressed fully.
- If tracking fails, the AF area blinks red.
- When set to [AFS], the focus will be on the AF area position. Tracking will not work.



- How to manipulate the AF area (→ [AF Area Operations: 206](#))



- In [AFM] mode and while recording video, tracking will continue even if the shutter button is released.

To cancel tracking, press  or , or touch .

Tracking is also available with [AFS].



- When automatic detection is working, the detected subject is tracked.
- Set [Metering Mode] to [M] to continue to adjust the exposure as well.
-  may not be available due to the camera settings.
- Tracking is not available when the following function is being used:
 - HDMI output when [Proxy Recording] and [Frame.io Connection] are set to [ON]

[Full Area AF]

The camera selects the most optimal AF area to focus.

When multiple AF areas are selected, all selected AF areas will be brought into focus.

When the focus mode is set to [AFC], you can ensure that the focus stays on the subject by recording while keeping the subject within the Full Area AF area.

Specify the Subject to Bring into Focus

When automatic detection is [ON], multiple subjects are detected.

When the subject to be brought into focus is shown using the white AF area, you can change this to a yellow AF area.

● Touch operations

Touch the subject indicated with the white AF area.

- The AF area will change to yellow.
- To cancel the setting, touch [].

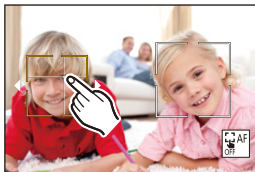

● Operations with the joystick



Tilt the joystick to ▲▼◀▶.

- Each tilt to ▲▼◀▶ switches the subject to be brought into focus.
- To cancel the setting, press .

● Button operations

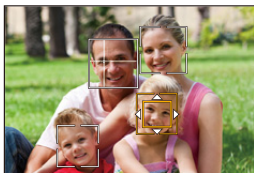
- 1 Press ▼ in the AF mode selection screen.
- 2 Press ▲▼◀▶ to move the position of the AF area.





- 3 When the white AF area changes to yellow, press  .
 - To cancel the setting, press .

❖ Setting the AF Area in Any Position

The [■] AF area can be set in any position.



● Touch operations

Touch any position on the recording screen and then touch [Set].



- Touch [] to return to [].

● Operations with the joystick

Press and hold the joystick.

- The [■] AF area is set in the center of the screen.
- Either press and hold the joystick again or press  to return to [].

● Button operations

- 1 Press ▼ in the AF mode selection screen.
- 2 Press ▲▼◀▶ to move the AF area, and then press  to confirm.
 - Press  again to return to [].



- You can move and change the size of the set AF area:
(→ [AF Area Operations: 206](#))

 [Zone(Horizontal/Vertical)] /  [Zone]

 [Zone(Horizontal/Vertical)]

Within the full area, vertical and horizontal zones can be focused.

Horizontal pattern



Vertical pattern

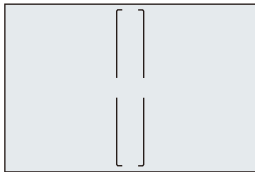

- To switch between the horizontal pattern and vertical pattern, press ▲▼◀▶ in the AF area setting screen.
- How to manipulate the AF area (→ [AF Area Operations: 206](#))

[Zone]

Within the full area, a central oval zone can be focused.

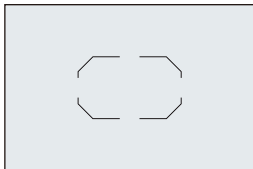

- How to manipulate the AF area (→ [AF Area Operations: 206](#))



- [.....] changes to [■] in the following cases:
 - During video recording
 - [M] mode

 [1-Area+]/  [1-Area]

 [1-Area+]

Emphasis within a single AF area can be focused.

Even when the subject moves out of the single AF area, the subject remains focused in a supplementary AF area (C).

- Effective when recording moving subjects that are difficult to track with [].

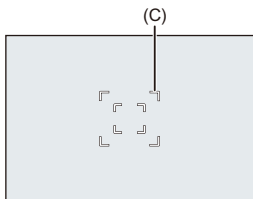

 [1-Area]

Specify the point to be brought into focus.

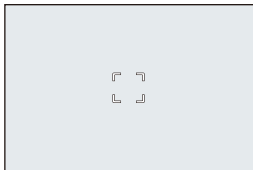

A dot (D) is displayed on the recording screen when a single AF area is reduced to the minimum size. The AF area can be set on the location where the dot is displayed.

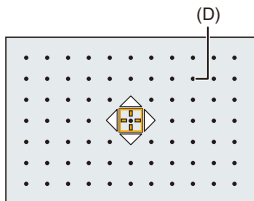

- How to manipulate the AF area (→ [AF Area Operations: 206](#))



- It is not possible to reduce a single AF area to the minimum when using the following function:
 - During video recording
 - [pM] mode
 - [Crop Zoom(Photo)]

[Pinpoint]

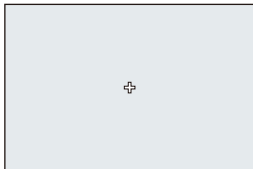

You can achieve a more precise focus on a small point.

If you press the shutter button halfway, the screen that lets you check the focus will be enlarged.





- The enlarged screen is displayed when you set an AF area.
- How to manipulate the AF area (→ [AF Area Operations: 206](#))



- When the focus mode is set to [AFC], [] is not available.
- Automatic detection does not work in [].



- When the following functions are being used, [] switches to []:
 - During video recording
 - [] mode

Operations on the Magnification Window

Button operations	Touch operations	Description of operation
	Touch	Moves [+]. • Positions can be moved to the diagonal directions using the joystick.
	Pinch out/ pinch in	Enlarges/reduces the screen in small steps.
	—	Enlarges/reduces the screen.
		Switches magnification window (windowed mode ^{*1} /full screen mode ^{*2}).
[DISP.]	[Reset]	Quits the enlarged display.

*1 You can enlarge by approx. 3× to 6×.

*2 You can enlarge by approx. 3× to 10×.

- You can also take a picture by touching [].



- You can change the display method of the magnified screen:
(→[Pinpoint AF Setting]: 637)

AF Area Operations

- [Move the Position of the AF Area: 206](#)
- [Changing the Size of the AF Area: 209](#)
- [Resetting the AF Area: 210](#)
- [Focus on and Adjust Brightness for the Touched Position \(\[AF+AE\]\): 211](#)
- [Moving the AF Area Position with the Touch Pad: 212](#)
- [\[Focus Switching for Vert / Hor\]: 214](#)



Move the Position of the AF Area

❖ Touch operations

With the default settings, focus is on the point touched when you touch the screen. (→ [\[Touch Settings\]: 640](#))

Touch the recording screen.

- The AF area setting screen is displayed.
The AF area is set when you either touch [Set] or press the shutter button halfway.



- You can optimize the focus and brightness on the touched position. (→ [Focus on and Adjust Brightness for the Touched Position \(\[AF+AE\]\): 211](#))
- You can focus on the touched position and release the shutter. (→ [Touch AF/Touch Shutter: 115](#))

❖ Operations with the joystick



With the default settings, the AF area can be manipulated with the joystick.
(→[Joystick Setting]: 645)

Tilt the joystick in the recording screen.

- The AF area setting screen is displayed.

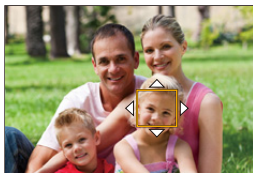
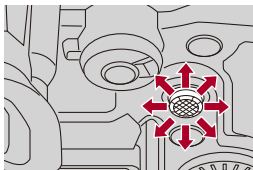
The AF area is set when you either press  or press the shutter button halfway.



- Pressing  enables switching between the default and set AF area positions.
In [, this operation displays the enlarged screen.

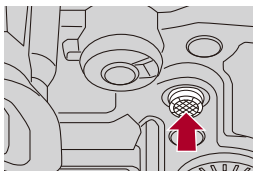

❖ Button operations

- 1 Press **▼** in the AF mode selection screen.
 - The AF area setting screen is displayed.
- 2 Press **▲▼◀▶** to move the position of the AF area.
 - The AF area is set when you either press  or press the shutter button halfway.



- When [Metering Mode] is [], the metering target also moves together with the AF area.



- You can set the AF area to loop when moved:
(→ [\[Looped Focus Frame\]: 639](#))
- You can assign the function that displays the AF area/MF Assist movement screens to an Fn button:
(→ [\[Focus Area Set\]: 604](#))

Changing the Size of the AF Area



❖ Touch operations

Pinch out/pinch in the AF area in the AF area setting screen.

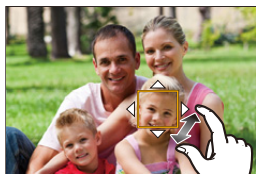
- Either touch [Set] or press the shutter button halfway to confirm.





❖ Dial Operations

Rotate , , or .

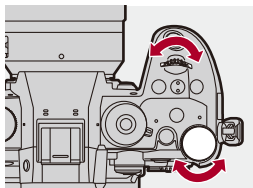
- Either press  or press the shutter button halfway to confirm.



- In [, [, and [, the size of the AF area cannot be changed.

Resetting the AF Area

❖ Touch operations

Touch [Reset] in the AF area setting screen.

- The first touch returns the AF area position to the center. The second touch returns the AF area size to the default.

❖ Button operations

Press [DISP.] in the AF area setting screen.

- The first press returns the AF area position to the center. The second press returns the AF area size to the default.

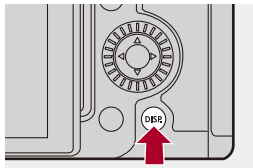

Focus on and Adjust Brightness for the Touched Position ([AF+AE])

1 Set [Touch AF].





-  → [] → [] → [Touch Settings] → [Touch AF] → [AF+AE]

2 Touch the subject to which you wish to adjust the brightness.

- At the touched position, an AF area that works in the same way as  is displayed. This places a point to adjust brightness at the center of the AF area.
- How to manipulate the AF area (→ [AF Area Operations: 206](#))





3 Touch [Set].

- The [AF+AE] setting is canceled if you touch  (when  or  is set: )) on the recording screen.

Moving the AF Area Position with the Touch Pad

During viewfinder display, you can touch the monitor to change the position and size of the AF area.

1 Set [Touch Pad AF].

-  → [] → [] → [Touch Settings] → [Touch Pad AF] → [EXACT]/[OFFSET1] to [OFFSET7]

2 Move the position of the AF area.

- During viewfinder display, touch the monitor.
- How to manipulate the AF area (→ [AF Area Operations: 206](#))

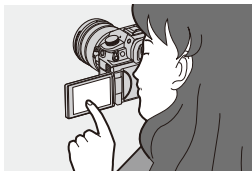

3 Confirm your selection.

- Press the shutter button halfway.

❖ Setting Items ([Touch Pad AF])

[EXACT]

Moves the AF area of the viewfinder by touching a desired position on the touch pad.

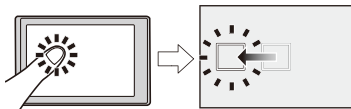

[OFFSET1] (entire area)/**[OFFSET2]** (right half)/**[OFFSET3]** (upper right)/**[OFFSET4]** (lower right)/**[OFFSET5]** (left half)/**[OFFSET6]** (upper left)/**[OFFSET7]** (lower left)

Moves the AF area of the viewfinder according to the distance you drag your finger on the touch pad.

Select the range to be detected with the drag operation.

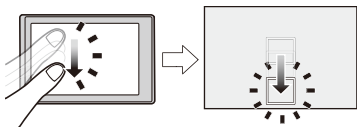

[OFF]

[Focus Switching for Vert / Hor]

Memorizes separate positions for AF areas for when the camera is vertically aligned and for when it is horizontally aligned.

Two vertical orientations, left and right, are available.



 ➔  ➔  ➔ **Select [Focus Switching for Vert / Hor]**

[ON]

Memorizes separate positions for vertical and horizontal orientations.

[OFF]

Sets the same position for vertical and horizontal orientations.



- In MF, this memorizes the MF Assist position.

Record Using MF

- [\[Focus Peaking\]: 220](#)



MF (Manual Focus) refers to manual focusing.

Use this function when you want to fix the focus or when the distance between the lens and the subject is determined and you do not want to activate AF.

1 Set the focus mode to [MF].

- Set the focus mode lever. (→ [Selecting the Focus Mode: 169](#))

2 Select the focus point.

- Tilt the joystick to select the focus point.
- To return the point to be brought into focus to the center, press [DISP].

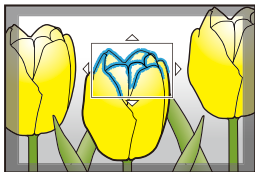

3 Confirm your selection.

- Press  .
- This switches to the MF Assist screen, and shows an enlarged display.

4 Adjust the focus.

- Rotate the focus ring.

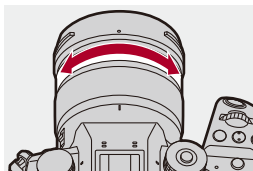

- This will display the in-focus portion highlighted with color. (Focus Peaking)
- A recording distance guideline is displayed. (MF Guide)

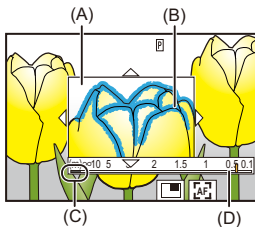

- (A) MF Assist (enlarged screen)
- (B) Focus Peaking
- (C) Indicator for ∞ (infinity)
- (D) MF Guide







5 Close the MF Assist screen.

- Press the shutter button halfway.
- This operation can also be performed by pressing  .

6 Start recording.

- Press the shutter button fully.

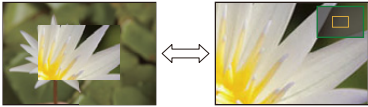
❖ Operations on the MF Assist Screen

Button operations	Touch operations	Description of operation
	Drag	Moves the enlarged display position. <ul style="list-style-type: none"> • Positions can be moved to the diagonal directions using the joystick.
	Pinch out/ pinch in	Enlarges/reduces the screen in small steps.
	—	Enlarges/reduces the screen.
		Switches magnification window (windowed mode ^{*1} /full screen mode ^{*2}). 
[DISP.]	[Reset]	First time: Returns the MF Assist position to the center. Second time: Returns the MF Assist magnification to the default setting.
[AF ON]		The AF operates.

*1 You can enlarge by approx. 3× to 6×.

*2 You can enlarge by approx. 3× to 20×. (Maximum 6× during video recording, when [Enlarged Live Display] in [HDMI Rec Output] is set to [OFF] during HDMI output, and when in [M] mode)



- On the recording screen, you can rotate the focus ring to display the MF Assist screen. If the focus ring has been rotated to enlarge the display, the assist screen will be exited a short time after you cease the operation.
- You can also display the MF Assist screen by pressing the [].
- During MF, pressing [AF ON] will activate AF.
- The MF Assist screen can also be displayed during video recording.
- The recording distance reference mark indicates the position of the imaging surface. This becomes the reference when measuring the recording distance.

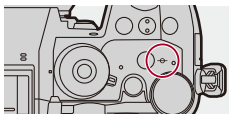

- When [Crop Zoom(Photo)] or [Crop Zoom(Video)] is [ON], the MF Assist magnification rate is between about 3× to 6×. (However, during video recording or in [ M] mode, this is fixed to 3×.)
- While you are using the following function, the MF Assist screen will not be displayed:
 - SH burst recording
- During video recording using the following functions, the MF Assist screen cannot be displayed:
 - [Rec Quality] with a high frame rate video exceeding a recording frame rate of 60.00p
 - [Variable Frame Rate]
 - [Live Cropping]



- You can change the Focus Peaking sensitivity and the display method:
(→[\[Focus Peaking\]: 220](#))
- You can memorize the MF Assist position separately for vertical and horizontal orientations:
(→[\[Focus Switching for Vert / Hor\]: 214](#))
- You can change the display method of the magnified screen:
(→[\[MF Assist\]: 635](#))
- You can change the MF Guide display units:
(→[\[MF Guide\]: 636](#))
- You can disable focus ring operation:
(→[\[Focus Ring Lock\]: 636](#))
- You can set the movement of the MF Assist position to loop:
(→[\[Looped Focus Frame\]: 639](#))
- The camera memorizes the focus point when you turn it off:
(→[\[Lens Focus Resume\]: 664](#))
- The amount of focus movement can be set:
(→[\[Focus Ring Control\]: 666](#))
- You can assign the function that displays the AF area/MF Assist movement screens to an Fn button:
(→[\[Focus Area Set\]: 604](#))

[Focus Peaking]

During MF operation, in-focus portions (portions on the screen with clear outlines) are highlighted with color.



→ [CAMERA]/[PEAKING] → [FOCUS] → **Select [Focus Peaking]**

[ON]	Focus Peaking display is performed.	
[OFF]	—	
[SET]	[Focus Peaking Sensitivity]	If adjusted to the negative direction, portions to be highlighted are reduced, allowing you to achieve a more precise focus.
	[Display Color]	You can set the display color of the in-focus portion.
	[Display During AFS]	When set to [ON], the Focus Peaking display is also possible when the shutter button is pressed halfway in the [AFS] focus mode.
	[Display During MF]	<p>[While In Live View]: Focus Peaking is displayed in the recording screen.</p> <p>[While Live View Is Enlarged]: Focus Peaking is displayed in the MF Assist screen and the video enlarged display of live view screen.</p> <p>[When Shutter Is Pressed]: When set to [OFF], Focus Peaking is hidden when the shutter is pressed.</p>



- You can display the Touch Tab (→ [\[Touch Settings\]: 640](#)) and then touch **[PEAK]** in **[<]** to switch [ON]/[OFF].
- When [Live View Boost] is being used, [Focus Peaking] is not available.

Recording with Zoom

- [Crop Zoom(Photo)]: 224
- [Crop Zoom(Video)]: 228
- [Power Zoom Lens]: 232



Use the optical zoom of the lens to zoom to telephoto or wide-angle.

Interchangeable lens with a zoom ring

Rotate the zoom ring.

(T): Telephoto

(W): Wide-angle

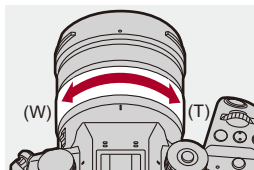

Interchangeable lens that supports power zoom (motorized zoom)

Move the zoom lever.

(The zoom speed varies depending on how far you move the lever.)

- If you assign [Zoom Control] to an Fn button, you can operate optical zoom slowly by pressing ◀▶ or fast by pressing ▲▼. (→ [Fn Buttons: 597](#))

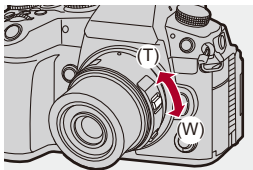

Interchangeable lens that does not support zoom

Optical zoom is not available.

- The focal length is displayed on the recording screen.

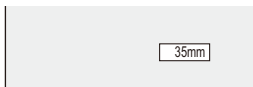

- The focal length display can be hidden:
(→ [Focal Length: 653](#))

[Crop Zoom(Photo)]



Cut out the central section of the image to get an enhanced telescopic effect without image quality deterioration.





It can even be used with a prime lens.

 ➔  ➔  ➔ **Select [Crop Zoom(Photo)]**

[ON]	Enables crop zoom.	
[OFF]	—	
[SET]	[Focal Length Display Setting]	Sets how focal length is displayed. [Composite Focal Length]: Result of the calculation “focal length of the optical zoom × crop zoom rate” (eg.: 180 mm) [+ Crop Magnification]: The focal length of the optical zoom and the crop zoom rate (eg.: 60 mm × 3.0)
	[Minimum Image Size]	A higher rate of zoom is possible the smaller the [Picture Size] is. [M]: maximum 1.4× [S]: maximum 2.0× [XS]: maximum approx. 3×
	[Set Recording Image Size]	[ON]: Always records with the [Picture Size] set in [Minimum Image Size]. [OFF]: [Picture Size] changes according to the zoom position.
	[Zoom Speed(Photo)]	Sets the zoom speed during zoom operations. Settings: [H], [M], [L], [SL]

❖ Using [Crop Zoom(Photo)]



1 Set [Crop Zoom(Photo)] to [ON].

-  ⇒ [] ⇒ [] ⇒ [Crop Zoom(Photo)] ⇒ [ON]
- While [Crop Zoom(Photo)] is set to [ON], zoom operations are enabled by pressing . ([Zoom Control] in [Fn Button Set] is allocated to .)

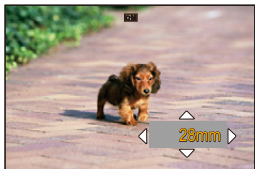
2 Perform the zoom operations.



Enlarge/Reduce

- Press  or rotate .
- When [Touch Tab] is set to [ON], you can enlarge/reduce with Touch Zoom.
- You can also enlarge/reduce by pressing the Fn button assigned with [Zoom In(Tele)] or [Zoom Out(Wide)].
- If the zoom operation has been enabled using the Fn button assigned with [Zoom Control], you cannot enlarge/reduce using .
- When using a power zoom lens, crop zoom works after enlarging the optical zoom to the maximum.



Step zoom

You can switch the crop zoom rate ([Minimum Image Size]).

1.0×[L] / 1.4×[M] / 2.0×[S] / approx. 3×[XS]

- Press .
- You can also switch by pressing the Fn button assigned with [Crop Zoom Increment(Step)].
- When using a power zoom lens, you can switch the crop zoom rate after enlarging the optical zoom to the maximum.

3 Confirm your selection.

- Press  or .
- Touch Zoom and the Fn buttons [Zoom In(Tele)], [Zoom Out(Wide)], and [Crop Zoom Increment(Step)] can also be used in the recording screen.



- RAW images are recorded without being cropped.



- The [Focal Length Display Setting] settings work together across the following menus:
 - [Crop Zoom(Photo)]
 - [Crop Zoom(Video)]
- When the following functions are being used, [Crop Zoom(Photo)] is not available:
 - [RAW] ([Picture Quality])
 - High Resolution mode

[Crop Zoom(Video)]



Cut out the central section of the image to get an enhanced telescopic effect without image quality deterioration.

It can even be used with a prime lens.











MENU SET → [] → [] → **Select [Crop Zoom(Video)]**



[ON]	Enables crop zoom.	
[OFF]	—	
[SET]	[Focal Length Display Setting]	<p>Sets how focal length is displayed.</p> <p>[Composite Focal Length]: Result of the calculation “focal length of the optical zoom × crop zoom rate” (eg.: 180 mm)</p> <p>[+ Crop Magnification]: The focal length of the optical zoom and the crop zoom rate (eg.: 60 mm × 2.7)</p>
	[Zoom Speed(Video)]	<p>[During Recording Standby]: Sets the zoom speed during recording standby.</p> <p>[During Recording]: Sets the zoom speed during recording.</p> <p>Settings: [H], [M], [L], [SL]</p>

❖ Using [Crop Zoom(Video)]







1 Set [Crop Zoom(Video)] to [ON].

-  ⇒ [] ⇒ [] ⇒ [Crop Zoom(Video)] ⇒ [ON]
- While [Crop Zoom(Video)] is set to [ON], zoom operations are enabled by pressing    . ([Zoom Control] in [Fn Button Set] is allocated to    .

2 Perform the zoom operations.





Enlarge/Reduce

- Press   or rotate  / .
- When [Touch Tab] is set to [ON], you can enlarge/reduce with Touch Zoom.
- You can also enlarge/reduce by pressing the Fn button assigned with [Zoom In(Tele)] or [Zoom Out(Wide)].
- If the zoom operation has been enabled using the Fn button assigned with [Zoom Control], you cannot enlarge/reduce using  / .
- When using a power zoom lens, crop zoom works after enlarging the optical zoom to the maximum.



Step zoom

You can switch the crop zoom rate ([Image Area of Video]).

FULL, PIXEL/PIXEL

- Press  .
- You can also switch by pressing the Fn button assigned with [Crop Zoom Increment(Step)].
- When using a power zoom lens, you can switch the crop zoom rate after enlarging the optical zoom to the maximum.

3 Confirm your selection.

- Press  or .
- Touch Zoom and the Fn buttons [Zoom In(Tele)], [Zoom Out(Wide)], and [Crop Zoom Increment(Step)] can also be used in the recording screen.

❖ **[Rec Quality] and Crop Zoom Rate**

[Rec Quality]	Maximum crop zoom rate
5.8K video, 5.7K video, 4.4K video	—
C4K video/4K video (120p/100p)	—
C4K video (60p/50p/48p/30p/25p/24p)	Approx. 1.3×
4K video (60p/50p/48p/30p/25p/24p)	Approx. 1.4×
FHD video (240p/200p/120p/100p)	—
FHD video (60p/50p/48p/30p/25p/24p)	Approx. 2.7×



- The [Focal Length Display Setting] settings work together across the following menus:
 - [Crop Zoom(Photo)]
 - [Crop Zoom(Video)]
- When the following functions are being used, [Crop Zoom(Video)] is not available:
 - [Rec Quality] for a high frame rate video exceeding a recording frame rate of 60.00p
 - [Variable Frame Rate] exceeding a frame rate of 60 fps
 - [Live Cropping]

[Power Zoom Lens]

This sets the zoom operation when using a lens that supports power zoom (motorized zoom).

- This is available when using a supported interchangeable lens.



Select [Power Zoom Lens]

[Step Zoom]	<p>When you operate the zoom with this setting [ON], the zoom will stop at preset focal length positions.</p> <ul style="list-style-type: none"> • This is not possible during video recording.
[Zoom Speed(Photo)]	<p>You can set the zoom speed for zoom operations.</p> <p>[H], [M], [L], [SL]</p>
[Zoom Speed(Video)]	<ul style="list-style-type: none"> • If you set [Step Zoom] to [ON], the zoom speed will not change.
[Zoom Ring]	<p>This can be selected when a lens compatible with power zoom that has a zoom lever and zoom ring is mounted on the camera. The operations with the zoom ring are disabled when set to [OFF] to prevent erroneous operation.</p>

Drive / Shutter / Image Stabilizer

This chapter describes functions for recording in drive mode and the image stabilizer function.

- [Selecting the Drive Mode: 234](#)
- [Taking Burst Pictures: 236](#)
- [High Resolution mode: 247](#)
- [Recording with Time Lapse Shot: 252](#)
- [Recording with Stop Motion Animation: 259](#)
- [Time Lapse Shot/Stop Motion Animation Videos: 263](#)
- [Recording Using the Self-timer: 265](#)
- [Bracket Recording: 269](#)
- [\[Live View Composite\]: 277](#)
- [\[Silent Mode\]: 281](#)
- [\[Shutter Type\]: 283](#)
- [Image Stabilizer: 292](#)

Selecting the Drive Mode



You can switch the drive mode to Single, Burst, etc. to match the recording conditions.

Rotating the drive mode dial.

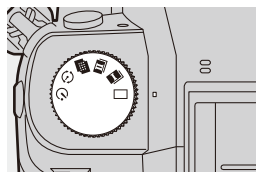

[] (Single)

Takes one picture each time the shutter button is pressed.

[]/[] (Burst) (→ [Taking Burst Pictures: 236](#))

Takes pictures continuously while the shutter button is pressed and held.

[] (High Resolution mode) (→ [High Resolution mode: 247](#))

This merges pictures with a high resolution from multiple recorded images.

[] (Time Lapse Shot/Stop Motion Animation) (→ [Recording with Time Lapse Shot: 252](#), [Recording with Stop Motion Animation: 259](#))

Takes pictures with Time Lapse Shot or Stop Motion Animation.

[] (Self-timer) (→ [Recording Using the Self-timer: 265](#))

Takes pictures when the set time elapses after the shutter button is pressed.



- The detailed setting screens for each drive mode can be called up with an Fn button:

[] ⇒ [] ⇒ [Fn Button Set] ⇒ [Setting in REC mode] ⇒ [Drive Mode Setting]

Taking Burst Pictures



Takes pictures continuously while the shutter button is pressed and held. You can select burst recording settings to suit the recording conditions, including [H], [M], and [L] which enable burst recording with high image quality, and SH burst recording which takes burst pictures at ultra high speeds using an electronic shutter.

1 Set the drive mode to [**I**] (Burst Shot 1) or [**II**] (Burst Shot 2).

- Set the drive mode dial. (→ [Selecting the Drive Mode: 234](#))
- Configure the burst settings for each of [**I**] and [**II**].

2 Select the burst rate.

- → [] → [] → [Burst Shot 1 Setting]/[Burst Shot 2 Setting]
- With the default settings, [H] is set for [**I**] and [SH75] is set for [**II**].



[SH75]

Takes burst pictures at ultra high speed with the electronic shutter, 75 frames/second.

[SH60]

Takes burst pictures at ultra high speed with the electronic shutter, 60 frames/second.

[SH20]

Takes burst pictures at ultra high speed with the electronic shutter, 20 frames/second.

[SH75 PRE]

Takes pre-burst pictures at ultra high speed, 75 frames/second. (→ [SH Pre-burst Recording: 239](#))

[SH60 PRE]

Takes pre-burst pictures at ultra high speed, 60 frames/second. (→ [SH Pre-burst Recording: 239](#))

[SH20 PRE]

Takes pre-burst pictures at ultra high speed, 20 frames/second. (→ [SH Pre-burst Recording: 239](#))

[H]

Takes high-speed burst pictures.

[M]

Takes medium-speed burst pictures.

[L]

Takes low-speed burst pictures.

3 Close the menu.

- Press the shutter button halfway.

4 Start recording.

- Takes burst pictures while the shutter button is pressed fully.

❖ SH Pre-burst Recording

The camera also records images for the set amount of time during the period between when the shutter button is pressed halfway and when it is pressed fully.

In [SH Burst Pre-Recording Time] you can set the length of time recordings are made before the shutter is pressed fully.

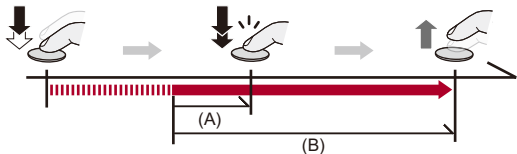

(A) [SH Burst Pre-Recording Time]

(B) Recorded range

MENU / **SET** → [📷] → [📷] → [Burst Shot Setting] → [SH Burst Pre-Recording Time]

[1.5SEC]

Recording starts from 1.5 seconds before the shutter button was pressed fully.

[1.0SEC]

Recording starts from 1 second before the shutter button was pressed fully.

[0.5SEC]

Recording starts from 0.5 seconds before the shutter button was pressed fully.

- The setting for [SH Burst Pre-Recording Time] is applied to both [Burst Shot 1 Setting] and [Burst Shot 2 Setting].
- [PRE] is displayed on the recording screen during SH pre-burst recording.
- If the shutter button is pressed and held at halfway for approx. 1 minute, the frames before pressing fully cannot be saved. Press the shutter button halfway again.

❖ Burst Rate

	Mechanical shutter	Electronic front curtain	Electronic shutter	Live View when taking burst pictures
[SH75]/ [SH75 PRE]	—	—	75 frames/ second ([AFS]/[MF])	None
[SH60]/ [SH60 PRE]	—	—	60 frames/ second ([AFS]/[AFC]/ [MF])	None
[SH20]/ [SH20 PRE]	—	—	20 frames/ second ([AFS]/[AFC]/ [MF])	None
[H] (High speed)	14 frames/ second ([AFS]/[MF]) 10 frames/ second ([AFC])	14 frames/ second ([AFS]/[MF]) 9 frames/ second ([AFC])	14 frames/ second ([AFS]/[MF]) 9 frames/ second ([AFC])	None ([AFS]/ [MF]) Available ([AFC])
[M] (Medium speed)	6 frames/second ([AFS]/[AFC]/[MF])			Available
[L] (Low speed)	2 frames/second ([AFS]/[AFC]/[MF])			Available

- The burst rate may be lower depending on the settings for recording such as [Picture Size] and focus mode.

❖ Maximum Number of Frames Recordable

	[Picture Quality]		
	[FINE]/[STD.]	[RAW+FINE]/ [RAW+STD.]	[RAW]
[SH75]/ [SH75 PRE]	190 frames*1		
[SH60]/ [SH60 PRE]			
[SH20]/ [SH20 PRE]			
[H] (High speed)	260 frames or more*2, 3/	170 frames or more*2, 3/	215 frames or more*2, 3/
[M] (Medium speed)	250 frames or more*2, 4	165 frames or more*2, 4	200 frames or more*2, 4
[L] (Low speed)			

- When recording under the test conditions specified by Panasonic.

Recording conditions may reduce the maximum number of frames recordable.

*1 Recording stops when the maximum number of frames recordable is reached.

For SH pre-burst recording, this includes the number of pictures taken with pre-burst recording.

*2 The burst rate will become lower during recording but pictures can continue to be taken until the card becomes full.

*3 Using a Nextorage CFexpress Type B card

*4 Using a Nextorage SDXC memory card compliant with UHS-II UHS Speed Class 3

❖ Number of Frames That Can Be Saved with Pre-burst Recording Before the Shutter Button Is Pressed Fully

[SH Burst Pre-Recording Time]	[SH75 PRE]	[SH60 PRE]	[SH20 PRE]
[1.5SEC]	113 frames	90 frames	30 frames
[1.0SEC]	75 frames	60 frames	20 frames
[0.5SEC]	38 frames	30 frames	10 frames

❖ Number of Pictures That Can Be Taken Continuously

When you press the shutter button halfway, the number of pictures that can be taken continuously will appear on the recording screen.

Example) When 20 frames: [r20]



- Once recording starts, the number of pictures that can be taken continuously will decrease.
 - During [H]/[M]/[L] burst recording: When [r0] appears, the burst rate decreases.
 - During SH burst recording: When [r0] appears, the burst recording stops.
- When [r99+] is displayed on the recording screen, you can take 100 or more burst pictures.

❖ Focus when Taking Burst Pictures

Focus mode	[Focus/ Shutter Priority] (→ [Focus/ Shutter Priority]: 634)	[SH75]/ [SH75 PRE]	[SH60]/ [SH60 PRE]/ [SH20]/ [SH20 PRE]/ [H]	[M]/[L]
[AFS]	[FOCUS]	Fixed to the focus of the first frame		
	[BALANCE]			
	[RELEASE]			
[AFC]	[FOCUS]	—	Estimated focus	Normal focus
	[BALANCE]		Estimated focus	
	[RELEASE]			
[MF]	—	Focus set with manual focus		

- When the subject is dark with [AFC], the focus is fixed to that of the first frame.
- With estimated focus, the burst rate takes priority and the focus is estimated to the extent possible.
- With normal focus, the burst rate may become slow.

❖ Exposure when Taking Burst Pictures

Focus mode	[SH75]/ [SH75 PRE]	[SH60]/ [SH60 PRE]/ [SH20]/ [SH20 PRE]/ [H]	[M]/[L]
[AFS]	Fixed to the exposure of the first frame		The exposure is adjusted for each frame
[AFC]	—	The exposure is adjusted for each frame	
[MF]	Fixed to the exposure of the first frame		



- It may take a while to save burst pictures.
If you continue to take burst pictures while saving is in progress, the maximum number of frames recordable will be reduced.
When taking burst pictures, we recommend using a high-speed card.
- Taking burst pictures does not work while you are using the following function:
 - [Live View Composite]

Notes on SH burst recording

- [Shutter Type] is fixed to [ELEC.].
- There are limits on the shutter speed you can set during SH burst recording.
 - [SH75]/[SH75 PRE]: To a minimum of 1/80
 - [SH60]/[SH60 PRE]: To a minimum of 1/60
 - [SH20]/[SH20 PRE]: To a minimum of 1/60
- The aperture will be fixed during burst recording.
- The images recorded will be saved as a set of burst group pictures. (→ [Group Images: 567](#))
- When the focus mode is set to [AFC], [SH75]/[SH75 PRE] is not available.

Notes on SH pre-burst recording

- Pictures taken before the shutter button is pressed fully are not saved in the following cases:
 - When recording with the Touch Shutter
 - When [Half-Press Shutter] in the [Custom] ([Focus/Shutter]) menu is set to [ON]
- When the ambient temperature is high or Pre-Burst recording is performed continuously, even if you press the shutter button halfway, Pre-Burst may not operate to protect the camera from overheating. Wait until the camera cools down.
- Even if you press the shutter button halfway, Pre-Burst may not operate when there is insufficient free space on the card.

High Resolution mode



This merges pictures with a high resolution from multiple recorded images.

This function is suitable for recording subjects that do not move.

When [Handheld High-Res] is set to on, you can record pictures with a higher resolution without using a tripod.

The picture after merging can be saved in RAW or JPEG format.



- When recording with [Handheld High-Res] set to [OFF], use a tripod to minimize camera shake.

1 Set the drive mode to [📷] (High resolution).

- Set the drive mode dial. (→ [Selecting the Drive Mode: 234](#))

2 Set the recording settings.

- → [📷] → [📷] → [High Resolution Mode Setting]

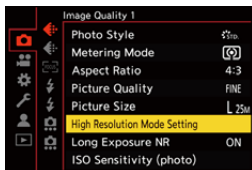

[Handheld High-Res]

You can record without using a tripod. Turn on the image stabilizer function.

- When [OFF], the image stabilizer function is not available.
-

[Picture Quality]

Set the compression rate at which the pictures are to be stored.

[COMBINED]/[FINE]/[RAW+FINE]/[RAW]

- When set to [COMBINED], recording is with the same settings as [Picture Quality] in the [Photo] ([Image Quality]) menu. (However, [STD.] changes to [FINE].)
-

[Picture Size]

Sets the image size after merging.

When the [Aspect Ratio] is [4:3].

[XL] (100 M): 11552×8672

[LL] (50.5 M): 8192×6144

When the [Aspect Ratio] is [3:2].

[XL] (89 M): 11552×7696

[LL] (44.5 M): 8192×5464

When the [Aspect Ratio] is [16:9].

[XL] (75 M): 11552×6496

[LL] (37.5 M): 8192×4608

When the [Aspect Ratio] is [1:1].

[XL] (75 M): 8672×8672

[LL] (37.5 M): 6144×6144

- RAW images are always recorded in the [4:3] (11552×8672) aspect ratio.
-

[Simul Record Normal Shot]

Simultaneously takes pictures that are not merged when [ON] is set. The first picture will be saved with [Picture Size] set to [L].

[Shutter Delay]

Sets the delay time from when the shutter button is pressed until the shutter is released.

[30 SEC]/[15 SEC]/[8 SEC]/[4 SEC]/[2 SEC]/[1 SEC]/[1/2 SEC]/[1/4 SEC]/[1/8 SEC]/[Off]

[Motion Blur Processing]

Sets the correction method to use when the subject moved.

[MODE1]: This gives priority to High Resolution mode, therefore subject blur appears as an afterimage in the picture.

[MODE2]: This reduces afterimage from subject blur, but cannot obtain the same High Resolution mode effect in the corrected range.

- When [Handheld High-Res] is [ON], [Motion Blur Processing] is fixed to [MODE2].
-

3 Decide on the composition and then fix the camera in place.

- If blurring is detected, the High Resolution mode icon (A) blinks.
- When [Handheld High-Res] is set to [ON], the icon changes to .



4 Start recording.

- Press the shutter button fully.
- With the default settings, [Shutter Delay] is activated, so there will be a gap in time from when the shutter button is pressed until the shutter is released.
- The screen goes dark during recording.
- The recording state indication (red) (B) blinks.
Do not move the camera while it is blinking.
- You can continue recording when the merging process ends.





- In High Resolution mode, recording will be performed using the following settings:
 - [Shutter Type]: Fixed to [ELEC.]
 - Minimum aperture value: F11
 - Shutter speed: 1 second to 1/32000 of a second
 - ISO sensitivity: Upper limit to [1600]
 - Focus mode: [AFS]/[MF]
- Hold the camera firmly during handheld recording so that the camera does not shake. Recording may fail if there is a lot of shaking.
- Image merging can take a long time with handheld recording.
- When you record in an extremely bright location or under lighting such as fluorescent or LED lighting, the coloring or brightness of the image may change or horizontal stripes may appear on the screen.
Lowering the shutter speed may reduce the effect of horizontal stripes.
- Devices other than this camera may not be able to play back images recorded using High Resolution mode.
- When the following function is being used, High Resolution Mode is not available:
 - [Live View Composite]

Recording with Time Lapse Shot



Pictures are taken automatically at a set recording interval.

This feature is ideal for keeping track of changes over time in subjects such as animals and plants.

The pictures taken will be saved as a set of group images that can also be combined into a video. (→ [Group Images: 567](#))





- Check that the clock is set correctly. (→ [Setting the Clock \(When Turning On for the First Time\): 75](#))
- For long recording intervals, we recommend setting [Lens Focus Resume] to [ON] in the [Custom] ([Lens / Others]) menu.

1 Set the drive mode to [].

- Set the drive mode dial. (→ [Selecting the Drive Mode: 234](#))

2 Set [Mode] to [Time Lapse Shot].

-  → [] → [] → [Time Lapse/Animation] → [Mode] → [Time Lapse Shot]

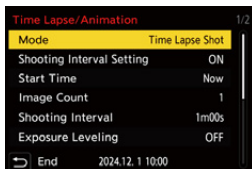

3 Set the recording settings.

[Mode]

Switches between Time Lapse Shot and Stop Motion Animation.

[Shooting Interval Setting]

[ON]: Sets the interval before the next recording takes place.

[OFF]: Takes pictures without leaving recording intervals.

[Start Time]

[Now]: Starts recording when the shutter button is pressed fully.

[After 2 Seconds]: Starts recording 2 seconds after the shutter button is pressed fully.

[Start Time Set]: Starts recording at the set time.

[Image Count]/[Shooting Interval]

Sets the number of pictures and the recording interval to be taken.

The number of pictures and the recording interval to be taken can be automatically calculated and set. (→ [Setting Assistant for Time Lapse Shot Recording: 255](#))

- [Shooting Interval] is not available when [Shooting Interval Setting] is set to [OFF].
-

[Exposure Leveling]

Adjusts the exposure automatically to prevent large changes in brightness between adjacent frames.

[Create New Folder At Rec]

[Create a New Folder]: When set to [ON], a new folder is created each time that Time Lapse Shot recording is started.

[File Number Reset]: When set to [ON], the file number is reset each time a new folder is created.

4 Close the menu.

- Press the shutter button halfway.

5 Start recording.

- Press the shutter button fully.
- When [Start Time Set] is set, the camera will enter into sleep status until the start time is reached.
- During recording standby, the camera enters into sleep status when no operation is performed for a certain period of time.
- The recording will stop automatically.

6 Create a video. (→ [Time Lapse Shot/Stop Motion Animation Videos: 263](#))

- After the recording has stopped, select [Yes] on the confirmation screen to proceed to create a video.

Even if you select [No], you can still create a video with [Time Lapse Video] in the [Playback] ([Process Image]) menu. (→ [\[Time Lapse Video\]: 588](#))

❖ Setting Assistant for Time Lapse Shot Recording

When [DISP.] is pressed in the [Image Count]/[Shooting Interval] setting screen, [Image Count] and [Shooting Interval] can be set by automatically calculating them from the frame rate, time, and recording duration of the video to be created.

- 1 Press ▲▼ to select the item and then press  or .

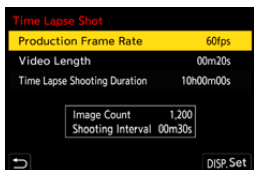

[Production Frame Rate]

Sets the frame rate of videos to be created.

It can be set in the range between 1 fps and 99 fps.

[Video Length]

Sets the playback time of videos to be created.

It can be set in the range between 00m01s and 99m59s.

[Time Lapse Shooting Duration]

Sets the Time Lapse Shot duration.

It can be set in the range between 00h00m01s and 99h59m59s.

- 2 Press [DISP.] to confirm.

- The settings are reflected when you select [Yes].



- [Image Count] can be set in the range between 1 and 9999.
- [Shooting Interval] is set in the range between 00m01s and 99m59s.
Decimal places are rounded down if the number is not evenly divisible.
- When the setting is one where recording is not possible, [Image Count] or [Shooting Interval] is displayed in red letters.
- When [Shooting Interval Setting] is [OFF], the Time Lapse Shot settings cannot be automatically calculated.

❖ Operations during Time Lapse Shot Recording

Pressing the shutter button halfway during sleep status will turn on the camera.

- You can perform the following operations by pressing [Q] during Time Lapse Shot recording.

[Continue]

Returns to the recording. (Only during recording)

[Pause]

Pauses the recording. (Only during recording)

[Resume]

Resumes the recording. (Only while paused)

- You can also press the shutter button to resume.

[End]

Stops the Time Lapse Shot recording.



- Pictures recorded to more than one card cannot be combined into a single video.
- The camera gives priority to achieving the standard exposure, so it may not take pictures at the set interval or take the set number of pictures.
Furthermore, it may not end at the end time displayed on the screen.
- Time Lapse Shot is paused in the following cases.
 - When the charge on the battery runs out
 - When you set the camera on/off switch to [OFF]
You can set the camera on/off switch to [OFF] and replace the battery or card. Set the camera on/off switch to [ON] and then press the shutter button fully to resume recording.
(Note that the images recorded after replacing the card will be saved as a separate set of group images.)
- [Exposure Leveling] is not available if ISO sensitivity is set to other than [AUTO] in [M] mode.
- [Time Lapse Shot] is not available when using the following function:
 - [Live View Composite]

Recording with Stop Motion Animation





Take pictures while moving the subject little by little.

The pictures taken will be saved as a set of group images that can be combined into a stop motion video. (→ [Group Images: 567](#))

1 Set the drive mode to [].

- Set the drive mode dial. (→ [Selecting the Drive Mode: 234](#))

2 Set [Mode] to [Stop Motion Animation].

-  → [] → [] → [Time Lapse/Animation] → [Mode] → [Stop Motion Animation]



3 Set the recording settings.

[Mode]

Switches between Time Lapse Shot and Stop Motion Animation.

[Add to Picture Group]

Allows you to continue recording for a set of stop motion images that have already been recorded.

- Select an image and proceed to Step **5**.

[Auto Shooting]

[ON]: Takes pictures automatically at a set recording interval.

[OFF]: This is for taking pictures manually, frame by frame.

[Shooting Interval]

Sets the recording interval for [Auto Shooting].

4 Close the menu.

- Press the shutter button halfway.

5 Start recording.

- Press the shutter button fully.
- Take pictures repeatedly while moving the subject little by little.
- The recording screen displays up to two pictures taken previously. Use them as reference for the amount of movement.
- You can play back the recorded stop motion images by pressing [▶] during recording.

Press [🗑️] to delete unnecessary images.

To return to the recording screen, press [▶] again.

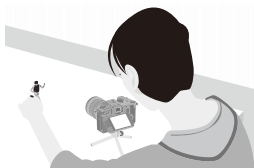

6 Stop recording.

- Press [MENU/SET] and then select [Time Lapse/Animation] from the [Photo] menu to stop recording.

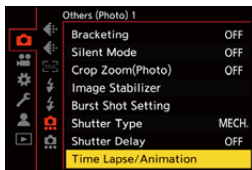

7 Create a video. (→[Time Lapse Shot/Stop Motion Animation Videos: 263](#))

- After the recording has stopped, select [Yes] on the confirmation screen to proceed to create a video.
Even if you select [No], you can still create a video with [Stop Motion Video] in the [Playback] ([Process Image]) menu. (→[\[Stop Motion Video\]: 588](#))



- Up to 9999 frames can be recorded.
- If the camera is turned off while recording, a message for resuming the recording is displayed when it is turned on. Selecting [Yes] allows you to continue the recording from the interruption point.
- The camera gives priority to achieving the standard exposure, so it may not take pictures at the set interval when the flash, etc. is used for recording.
- A picture cannot be selected from [Add to Picture Group] when it is the only one that was taken.
- [Stop Motion Animation] is not available when using the following function:
 - [Live View Composite]
 - [Frame.io Connection]

Time Lapse Shot/Stop Motion Animation Videos

After performing Time Lapse Shot or stop motion recording, you can proceed to create a video.

- Refer to the sections below about these recording functions.
 - [Recording with Time Lapse Shot: 252](#)
 - [Recording with Stop Motion Animation: 259](#)
- You can also create videos with [Time Lapse Video] (→[\[Time Lapse Video\]: 588](#)) or [Stop Motion Video] (→[\[Stop Motion Video\]: 588](#)) in the [Playback] menu.

- 1 Select [Yes] on the confirmation screen that appears after recording.**
- 2 Set the options for creating a video.**
- 3 Select [OK].**

- A video will be created in the [MP4] recording file format.

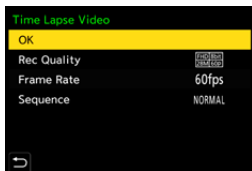

[OK]

Creates a video.

[Rec Quality]

Sets the video image quality.

[Frame Rate]

Sets the number of frames per second.

The larger the number is, the smoother the video will be.

[Sequence]

[NORMAL]: Splices pictures together in recording order.

[REVERSE]: Splices pictures together in reverse recording order.



- Videos cannot be created when the [System Frequency] is set to [24.00Hz (CINEMA)].
- Videos cannot be created if the recording time exceeds 30 minutes.
- In the following cases, videos cannot be created if the file size exceeds 4 GB:
 - When an SDHC memory card is being used and a 4K [Rec Quality] is set
 - When an FHD [Rec Quality] is set
- [Time Lapse Video] is not available when using the following functions:
 - [Auto Transfer] (when there is an image queued to be transferred)
 - [Send Images to Frame.io] (when there is an image in the upload queue)

Recording Using the Self-timer



1 Set the drive mode to [☺].

- Set the drive mode dial. (→ [Selecting the Drive Mode: 234](#))

2 Set the self-timer time. (→ [Setting the Self-timer Time: 267](#))

- When recording videos, set [Self Timer For Video] in [Self Timer Setting] of the [Video] ([Others (Video)]) menu to [ON].

3 Close the menu.

- Press the shutter button halfway.

4 Decide on the composition and then adjust the focus.

- Press the shutter button halfway.
- The focus and exposure are fixed when the shutter button is pressed halfway.



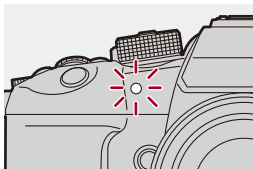

5 Start recording.

- Press the shutter button, video rec. button, or sub video rec. button.
- After the self-timer light blinks, shooting or video recording starts.









❖ Setting the Self-timer Time

Picture:  → [] → [] → Select [Self Timer]

Video:  → [] → [] → [Self Timer Setting] → Select [Self Timer]*

* This can be set by setting [Self Timer For Video] to [ON] in [Self Timer Setting] in the [Video] ([Others (Video)]) menu.

	Takes a picture after 10 seconds.	
	Takes 3 pictures at approx. 2 second intervals after 10 seconds. (When recording video, it will be the same operation with )	
	Takes a picture after 2 seconds. • This setting is a convenient way to avoid camera shake caused by pressing the shutter button.	
 to  (Custom)	Takes a picture after the time selected with [Custom Time].	
[SET]	[Custom Time]	Sets the time until recording starts. [10SEC]/[9SEC]/[8SEC]/[7SEC]/[6SEC]/ [5SEC]/[4SEC]/[3SEC]/[2SEC]
	[Display Countdown]	A countdown is displayed on the recording screen when the self-timer is Custom.



- We recommend using a tripod when recording with the self-timer.



- [Self Timer] in the [Photo] ([Others (Photo)]) menu and [Self Timer] in the [Self Timer Setting] ([Video] ([Others (Video)]) menu) work together.
- When the following functions are being used, [⏸️] is not available:
 - [Simultaneous Record w/o Filter] ([Filter Settings])
 - [Bracketing]
 - [Live View Composite]

Bracket Recording



When the shutter button is pressed, the camera can record multiple images while automatically changing the setting value for exposure, aperture, focus or white balance (adjustment value or color temperature).



- Aperture Bracket can be selected in the following modes:
 - [A] mode
 - [M] mode (when ISO sensitivity is set to [AUTO])
- White Balance Bracket (Color Temperature) can be selected when the white balance is set to [K₁], [K₂], [K₃], or [K₄].

1 Set [Bracketing Type].

- → [] → [] → [Bracketing] → [Bracketing Type]

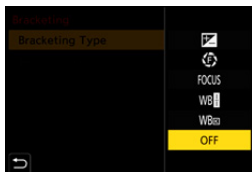

2 Set [More Settings].

- For information about [More Settings], refer to page for each bracketing method.

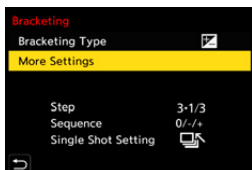

3 Close the menu.

- Press the shutter button halfway.

4 Focus on the subject and then take pictures.

❖ Setting Items ([Bracketing Type])

[] (Exposure Bracket)

When the shutter button is pressed, the camera records while changing the exposure.

(→[More Settings] (Exposure Bracket): 273)

[] (Aperture Bracket)

When the shutter button is pressed, the camera records while changing the aperture value.

(→[More Settings] (Aperture Bracket): 274)

[FOCUS] (Focus Bracket)

When the shutter button is pressed, the camera records while changing the focus point.

(→[More Settings] (Focus Bracket): 275)

[WB] (White Balance Bracket)

When the shutter button is pressed once, the camera automatically records three images with the different white balance adjustment values.

(→[More Settings] (White Balance Bracket): 276)

[WB] (White Balance Bracket (Color Temperature))

When the shutter button is pressed once, the camera automatically records three images with the different white balance color temperatures.

(→[More Settings] (White Balance Bracket (Color Temperature)): 276)

[OFF]

❖ How to Cancel Bracketing

Select [OFF] in Step 1.



- White Balance Bracket and White Balance Bracket (Color Temperature) are not available when using the following functions:
 - [iA] mode
 - Taking burst pictures
 - [RAW+FINE]/[RAW+STD.]/[RAW] ([Picture Quality])
 - [Filter Settings]
- Bracket recording is not available while you are using the following functions:
 - SH burst recording
 - [Time Lapse Shot]
 - [Stop Motion Animation] (when [Auto Shooting] is set)
 - High Resolution mode
 - [Live View Composite]

❖ [More Settings] (Exposure Bracket)

[Step]

Sets the image count and exposure compensation step.

[3•1/3] (record 3 images in 1/3 EV steps) to **[7•1]** (record 7 images in 1 EV steps)

[Sequence]

Sets the order in which images are recorded.

[Single Shot Setting]

[□]: Takes only one image each time the shutter button is pressed.

[📷]: Takes all of the set number of images when the shutter button is pressed once.

- The [BKT] icon blinks until all of the set number of pictures is taken.
-



- When you record images with Exposure Bracket after setting the exposure compensation value, the images recorded are based on the selected exposure compensation value.

❖ [More Settings] (Aperture Bracket)

[Image Count]

[3]/[5]: Records the set number of images while alternately setting the aperture value in the sequence of one before and then one after using the initial aperture value as the reference.

[ALL]: Records images using all aperture values.

Example when the initial position is set to F8.0 (H-ES12060)

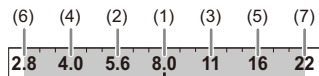

(1) 1st image, (2) 2nd image, (3) 3rd image ... (7) 7th image

❖ [More Settings] (Focus Bracket)

[Step]

Sets the focus adjustment step.

- The distance that the focus point is moved becomes shorter if the initial focus point is close, and longer if it is far away.

[Image Count]

Sets the image count.

- This cannot be set when taking burst pictures.
Burst pictures are taken while the shutter button is pressed.

[Sequence]

[0/-/+]: Records while alternately moving the focus point in the sequence of forward and then backward using the initial focus point as the reference.

[0/+]: Records while moving the focus point toward the far side using the initial focus point as the reference.

Example when [Sequence]: [0/-/+] is set

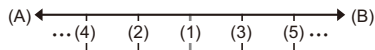

Example when [Sequence]: [0/+] is set

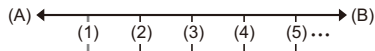

(A) Focus: closer

(B) Focus: more distant





(1) 1st image, (2) 2nd image ... (5) 5th image ...



- When [Focus Limiter] is set, recording is within the set range where AF works.
- Pictures recorded with Focus Bracket are displayed as images of one group.

(→ [Group Images: 567](#))

❖ [More Settings] (White Balance Bracket)





Rotate ,  or  to set the correction step and then press  or .

Rotate to the right:

Horizontal direction ([A] - [B])





Rotate to the left:

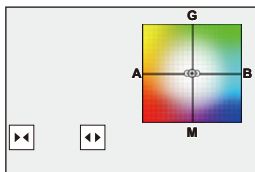

Vertical direction ([G] - [M])

- The correction step can also be set by touching []/[]/[]/[].



❖ [More Settings] (White Balance Bracket (Color Temperature))

Rotate ,  or  to set the correction step and then press  or .

- The correction step can also be set by touching []/[].

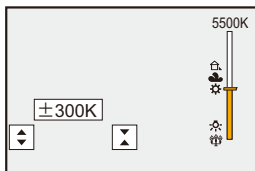

[Live View Composite]



Images are recorded over several times and only the parts that change to become brighter form part of the composition.

The images composed by recording at a set exposure time (shutter speed) are displayed, allowing the images to be confirmed as recording proceeds. This allows you to reduce the overall brightness for recording, so it is convenient for recording the light trails of stars or fireworks against a bright nightscape.



- Use a tripod to minimize camera shake.

1 Set the recording mode to [M].

- Set the mode dial. (→ [Selecting the Recording Mode: 82](#))

2 Set [Live View Composite].

- → [] → [] → [Live View Composite]

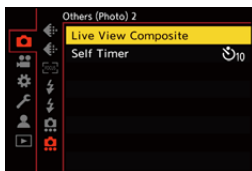





3 Start Live View Composite recording.

- Select [Start] and then press or .

4 Decide on the composition and then fix the camera in place.

5 Set the shutter speed and ISO sensitivity.

- Rotate  to set the shutter speed.
- Press [ISO], then rotate , , or  to set the ISO sensitivity.
- The shutter speed can be set in the range between 60 seconds and 1/1.6 of a second. The range of ISO sensitivities you can set depends on the Photo Style used.
- The ISO sensitivity can be set in the range between [100] and [1600] ([50] and [1600] when [Extended ISO] is set).

6 Get the image to use for noise reduction.

- Press the shutter button fully.

7 Start recording.

- Press the shutter button fully.
- Recording is done according to the settings in Step 5, and images processed with noise reduction are merged a frame at a time.

(A) Histogram display

(B) Shutter speed × Number of images merged

(C) Elapsed time

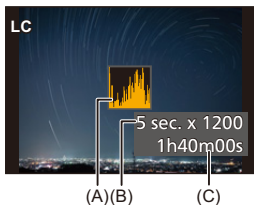

8 Stop recording.

- Press the shutter button fully.
- A maximum of 3 hours can be recorded with one Live View Composite recording.
(Recording automatically ends when the time exceeds 3 hours.)

9 End [Live View Composite].

- Press [Q].

❖ Setting Items ([Live View Composite])

[Start]

Starts Live View Composite recording.

[Shutter Delay]

Sets the delay time from when the shutter button is pressed until the shutter is released.

[8 SEC]/[4 SEC]/[2 SEC]/[1 SEC]/[OFF]



- [Long Exposure NR] will be [ON].
- When recording with the flash, the flash fires only in the first frame.
- Some menus are not displayed after getting the noise reduction image.
- The image for noise reduction is discarded when you do the following. Do Step **6** again.
 - Modify the shutter speed/ISO sensitivity
 - Switch the playback mode
- When pressing the shutter button fully to end recording, the last image may not be merged.
- During Live View Composite recording, audio is not output to an external device connected by HDMI.
- [Live View Composite] is not available when using the following functions:
 - [ELEC.]/[ELEC.+NR] ([Shutter Type])
 - High Resolution mode
 - [Filter Settings]
 - [Silent Mode]

[Silent Mode]



This disables all operation sounds and light output at once.

The audio from the speaker will be muted and the flash and the AF assist light will be set to forced off mode.

• The following settings are fixed:

- [Flash Mode]: [] (Forced Flash Off)
- [AF Assist Light]: [OFF]
- [Shutter Type]: [ELEC.]
- [Front Tally Lamp]: [OFF]
- [Rear Tally Lamp]: [OFF]
- [Beep Volume]: [] (OFF)
- [AF Beep Volume]: [] (OFF)
- [E-Shutter Vol]: [] (OFF)

Picture: ⇒ [] ⇒ [] ⇒ **Select [Silent Mode]**

Video: ⇒ [] ⇒ [] ⇒ **Select [Silent Mode]**

Settings: [ON]/[OFF]





- Even when [ON] is set, the following functions light/blink:
 - Power indicator
 - Charging light/Network connection light
 - Card access lights
 - Self-timer light
- [Silent Mode] is not available when using the following function:
 - [Live View Composite]
- Use this function at your own responsibility sufficiently considering the privacy, portrait, and other rights of subjects.

[Shutter Type]

- [Long Exposure NR]: 287
- [Synchro Scan(Photo)]: 288
- [Min. Shutter Speed]: 290
- [Shutter Delay]: 291



Selects the shutter type to use for taking pictures.

MENU / SET → **[📷]** → **[⚙️]** → **Select [Shutter Type]**

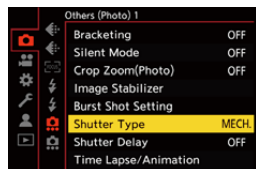

[AUTO]

Switches the shutter type automatically depending on the recording conditions and shutter speed.

[MECH.]

Records with the mechanical shutter type.

[EFC]

Records with the electronic front curtain type.

[ELEC.]

Records with the electronic shutter type.

[ELEC.+NR]

Records with the electronic shutter type.

When pictures are taken at slower shutter speeds, the shutter is closed after recording to perform long shutter noise reduction.

	Mechanical shutter type	Electronic front curtain type	Electronic shutter type
Mechanism	This type starts and ends exposure with the mechanical shutter.	This type starts exposure electronically and ends it with the mechanical shutter.	This type starts and ends exposure electronically.
Flash	✓	✓	—
Shutter speed (sec.)	[B] (Bulb, max. approx. 30 minutes) ^{*1} , 60 to 1/8000	[B] (Bulb, max. approx. 30 minutes) ^{*1} , 60 to 1/2000	[B] (Bulb, max. approx. 60 seconds) ^{*1} , 60 to 1/32000
Shutter sound	Mechanical shutter sound	Mechanical shutter sound	Electronic shutter sound ^{*2}

*1 This setting is available only in [M] mode.

*2 The electronic shutter sound can be set in [E-Shutter Vol] and [E-Shutter Tone] in [Beep] of the [Setup] ([IN/OUT]) menu. (→[Beep]: 683)

- The electronic front curtain type reduces blur caused by the shutter because the amount of vibration from the shutter is small compared to the mechanical shutter type.
- The electronic shutter type allows you to record without vibration from the shutter.



- To reduce shutter-induced blur, you can set the shutter to release a few seconds after the shutter button is pressed:

(→ [Shutter Delay]: 291)



- When [E] is displayed on the screen, recording will be with the electronic shutter type.
- When a moving subject is recorded using the electronic shutter, the subject may appear distorted in the picture.
- When you record using the electronic shutter under lighting such as fluorescent or LED lighting, horizontal stripes may be recorded. In such a case, lowering the shutter speed may reduce the effect of horizontal stripes.

[Long Exposure NR]



The camera automatically removes noise generated when recording images with a slow shutter speed.

 →  →  → **Select [Long Exposure NR]**

Settings: [ON]/[OFF]



- Recording is not possible during noise reduction.
- When the following functions are being used, [Long Exposure NR] is not available:
 - Video recording/SH burst recording
 - [ELEC.] (Excluding [ELEC.+NR])/[Silent Mode]
 - High Resolution mode

[Synchro Scan(Photo)]



The flicker or horizontal stripes of the light source can be mitigated by making fine adjustments to the shutter speed.

The shutter speed set in Synchro Scan is saved separately from the shutter speed used for normal recording. In the Synchro Scan setting screen, you can call up the current shutter speed for normal recording and adjust it.

1 Set the recording mode to [S] or [M].







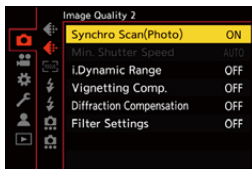

- Set the mode dial. (→ [Selecting the Recording Mode: 82](#))

2 Set [Synchro Scan(Photo)].

- → [] → [] → [Synchro Scan(Photo)] → [ON]



3 Set the shutter speed.

- Rotate ,  or  to select a numeric value, then press  or .
- The shutter speed can be set in the range between 1/48.0 and 1/8192.0 of a second.
- Press   to change the shutter speed in 1/4 TV intervals. Press   to make fine adjustments.
- You can call up the current shutter speed for normal recording by pressing [DISP.].
- Make adjustments to the shutter speed while looking at the screen until there is no noticeable flickering or horizontal stripes.



- There may be a difference between what you see on the recording screen and the actual results of recording. We recommend shooting some tests beforehand.
- To record video using the values set in [Synchro Scan(Photo)], set [Auto Exposure in P/A/S/M] to [OFF].
- When the following function is being used, [Synchro Scan(Photo)] is not available:
 - [MECH.]

[Min. Shutter Speed]



Sets the minimum shutter speed when the ISO sensitivity is set to [AUTO].

 →  →  → **Select [Min. Shutter Speed]**

[AUTO]

The camera automatically sets the minimum shutter speed.

[1/32000] to [1/1]



- The shutter speed may become slower than the set value in recording situations where correct exposure cannot be achieved.

[Shutter Delay]



To reduce camera shake and shutter-induced blur, the shutter is released after the specified time has passed since the shutter button was pressed.

 →  →  → **Select [Shutter Delay]**

Settings: [8SEC]/[4SEC]/[2SEC]/[1SEC]/[OFF]



- When the following functions are being used, [Shutter Delay] is not available:
 - Video recording/SH burst recording
 - High Resolution mode
 - [Live View Composite]

Image Stabilizer

- [Image Stabilizer Settings: 295](#)







This camera can use both the in-body image stabilizer and the in-lens image stabilizer.

It is compatible with the Dual I.S.2 system that is an effective combination of the 2 image stabilizers.

Furthermore, during video recording, you can use the 5-Axis Hybrid Image Stabilizer that incorporates electronic stabilization.

Combinations of lenses and image stabilizers (As of May 2024)

Image stabilizers that can be used will differ depending on the attached lens.

Attached lens	Available image stabilizer	Example of icon
Panasonic lenses compatible with Dual I.S. mode (Based on the Micro Four Thirds system standard)*	Body+Lens (Dual I.S./Dual I.S.2)	DUAL / DUAL2 
Lenses compatible with the image stabilizer function (Based on the Micro Four Thirds system standard)	Body or Lens	
Lenses without image stabilizer function	Body	
Lenses without function to communicate with this camera	Body	

* If the [DUAL] or [DUAL2] icon is not displayed on the recording screen even when a compatible lens is used, update the lens firmware to the latest version.

(→ [Firmware of Your Camera/Lens: 20](#))

- The 5-Axis Hybrid Image Stabilizer (→ [\[E-Stabilization \(Video\)\]: 298](#)) can be used with any lenses.

❖ Using the Image Stabilizer

- When using a lens with an O.I.S. switch, set the switch on the lens to [ON].
- When using a lens that does not have a communication function with this camera, after turning on the camera, a message asking for confirmation of the lens information is displayed.

Correctly operating the image stabilization function requires that the focal length be set to match the attached lens.

Set the focal length in accordance as prompted by the message.

This can also be set using the menu. (→[[Lens Information](#)]: 300)



- When the shutter button is pressed halfway, the camera shake alert icon [([⊙])]] may be displayed on the recording screen.

If this is displayed, we recommend using a tripod, the self timer or the Shutter Remote Control (DMW-RS2: optional).

- We recommend turning off the image stabilizer function when using a tripod.



- The image stabilizer may cause vibration or produce operational sound during operation, but these are not malfunctions.



- When using a lens that does not have a communication function with this camera, you can hide the message asking for confirmation of the lens information that is displayed after turning on the camera:

(→[[Lens Info. Confirmation](#)]: 667)

- You can display the reference point and check the camera shake status:
(→[[I.S. Status Scope](#)]: 655)

Image Stabilizer Settings

Set the image stabilizer operation to match the recording situation.

Picture:  →  →  → **Select [Image Stabilizer]**

Video:  →  →  → **Select [Image Stabilizer]**

[Operation Mode]

Sets the stabilization movement (blur) to match the recording method (normal, panning). (→ [\[Operation Mode\]: 297](#))

[E-Stabilization (Video)]

Through the combined use of the in-lens, in-body, and electronic image stabilizers, corrections are made to camera shake on 5 axes during video recording along the vertical, horizontal, roll, pitch, and yaw axes, and to the peripheral distortion that readily occurs when you are using a wide-angle lens. (5-Axis Hybrid Image Stabilizer) (→ [\[E-Stabilization \(Video\)\]: 298](#))

[Boost I.S. (Video)]

Increases the effectiveness of the image stabilizer during video recording. This effect can help provide a stable composition when you want to perform recording from a fixed perspective. (→ [\[Boost I.S. \(Video\)\]: 299](#))

[Anamorphic (Video)]

You can switch to an image stabilizer that suits anamorphic recording. (→ [\[Anamorphic \(Video\)\]: 299](#))

[Lens Information]

When using a lens that does not have a communication function with the camera, register the lens information in the camera. (→ [\[Lens Information\]: 300](#))



- When the following functions are being used, [E-Stabilization (Video)] is not available:
 - [Variable Frame Rate]
 - [Live Cropping]
- While you are using the following functions, [HIGH] in [E-Stabilization (Video)] is not available:
 - Other than [OFF] in [Anamorphic (Video)]

❖ [Operation Mode]

Set the stabilization movement (blur) to match the recording method (normal, panning).

[Normal]

Corrects vertical, horizontal, and rotational camera shake.

This function is suitable for normal recording.

[Panning (Left/Right)]

Corrects vertical camera shake.

This is suitable for horizontal panning.



[Panning (Up/Down)]

Corrects horizontal camera shake.

This is suitable for vertical panning.

[OFF]

Turns the image stabilization function OFF.

- The [Operation Mode] that can be used differ depending on the lens used.
- [Operation Mode] is fixed to [] ([Normal]) when using other manufacturers' lenses with an image stabilization function.
- When using lenses with an O.I.S. switch, the camera's operation mode cannot be set to [OFF]. Set the switch on the lens to [OFF].
- When the following functions are being used, [Operation Mode] switches to [] ([Normal]):
 - [] mode
 - Video recording

❖ [E-Stabilization (Video)]

Through the combined use of the in-lens, in-body, and electronic image stabilizers, corrections are made to camera shake on 5 axes during video recording along the vertical, horizontal, roll, pitch, and yaw axes, and to the peripheral distortion that readily occurs when you are using a wide-angle lens. (5-Axis Hybrid Image Stabilizer)

[HIGH]

Large shakes and peripheral distortion are corrected electronically.

The angle of view is narrower than [STANDARD].

- [] is displayed on the screen during video recording.
-

[STANDARD]

Shakes and peripheral distortion are corrected electronically.

The angle of view is narrower.

- [] is displayed on the screen during video recording.
-

[OFF]

Turns the electronic image stabilizer (video) OFF.



- There will be variation in the effectiveness of the correction depending on the video mode used for recording and the recording conditions.
- Using [E-Stabilization (Video)] may cause a drop in resolution.

❖ [Boost I.S. (Video)]

Increase the effectiveness of the image stabilizer during video recording. This effect can help provide a stable composition when you want to perform recording from a fixed perspective.





Settings: [ON]/[OFF]



- When [Boost I.S. (Video)] is operating, [] is displayed on the recording screen.
- To change composition while recording, first set this to [OFF] before moving the camera.
To set this to [OFF] during recording, use the Fn button. (→ [Fn Buttons: 597](#))
- Longer focal lengths will result in weaker stabilization.

❖ [Anamorphic (Video)]

You can switch to an image stabilizer that suits anamorphic recording.

Settings:

[]([2.0×])/[]([1.8×])/[]([1.5×])/[]([1.33×])/[]([1.30×])/[OFF]

- Make settings to suit the magnification of the anamorphic lens you are using.
- While [Anamorphic (Video)] is functioning, the set magnification appears on the image stabilizer icons on the recording screen, as shown by [] and [].





- When [Boost I.S. (Video)] is set, [Boost I.S. (Video)] is prioritized.
- Image stabilizer functions on your lens may not work correctly. Turn off the image stabilizer function on your lens if this is the case.

❖ [Lens Information]





Register the information for lenses that cannot communicate with the camera.

Match the in-body image stabilizer with the information of the lens you register.

Press ▲▼ to select the lens information to use and then press  or .

- In the default setting, the lens information for 6 lenses with a focal length of between 24 mm and 135 mm is registered.
- The lens information for up to 12 lenses can be registered.

Registering, modifying, and deleting lens information

- 1 Press ▲▼ to select the lens information and then press [DISP.].
 - If lens information that has not been registered is selected, press  or  to proceed to Step 3.
- 2 Press ▲▼ to select [Edit], [Sorting], or [Delete] and then press  or .
 - You can change the display order of lens information by selecting [Sorting].
 - The lens information is deleted when you select [Delete].
 - You cannot delete the lens information for a lens that is being used.
- 3 Enter the lens Information.
 - The lens information changes if the lens information has already been registered.
- 4 (If lens information that has not been registered is selected) Press [DISP.] to register the lens information.

[Focal Length]

Enter the focal length.

- The live view images can be enlarged for display when you rotate  .
-

[Lens Name]

Register the lens.

- How to enter characters (→ [Entering Characters: 108](#))
 - Up to a maximum of 30 characters can be entered.
-

Metering / Exposure / ISO

Sensitivity

This chapter describes recording modes for determining exposure and ISO sensitivity.

- [\[Metering Mode\]: 303](#)
- [Program AE Mode: 305](#)
- [Aperture-Priority AE Mode: 309](#)
- [Shutter-Priority AE Mode: 312](#)
- [Manual Exposure Mode: 315](#)
- [Preview Mode: 320](#)
- [Exposure Compensation: 322](#)
- [Locking Focus and Exposure \(AF/AE Lock\): 326](#)
- [ISO Sensitivity: 328](#)

[Metering Mode]



Type of optical measurement to measure brightness can be changed.

MENU / SET → [] / [] → [] → **Select [Metering Mode]**



[] (Multi-metering)

Method in which the most suitable exposure is measured by judging the allocation of brightness on the whole screen.

[] (Center-weighted)

Method used to perform measuring which focuses on the center of the screen.

[] (Spot)

Method used to measure the extremely small part around the spot-metering target (A).

- When you move the AF area, the spot metering target also moves to match.

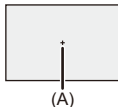

(Highlight-weighted)

Method used to perform measuring which focuses on the highlighted parts of the screen to prevent overexposure.

This is suitable for theatre photography, etc.



- The standard value for standard exposure can be adjusted:
(→ [\[Exposure Offset Adjust.\]: 630](#))
- You can assign the function that records with the metering mode set to 
(Spot) once only to an Fn button:
(→ [\[1 Shot Spot Metering\]: 603](#))

Program AE Mode

- [Program Shift: 307](#)



In [P] mode (Program AE mode), the camera automatically sets the shutter speed and aperture value for the brightness of the subject.

You can also use Program Shift to change combinations of shutter speed and aperture values while keeping the same exposure.

1 Set the recording mode to [P].

- Set the mode dial. (→ [Selecting the Recording Mode: 82](#))

2 Press the shutter button halfway.

- This displays the aperture value and shutter speed value on the recording screen.

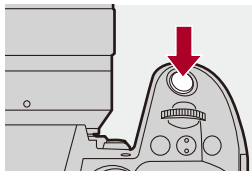

- If the correct exposure is not achieved, the aperture value (A) and shutter speed (B) blink red.

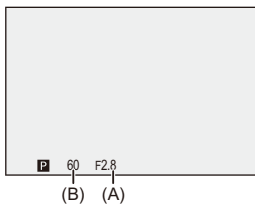

3 Start recording.

Program Shift

You can change the shutter speed and aperture value combination set automatically by the camera while maintaining the same exposure. With this, you can, for example, make the background more defocused by decreasing the aperture value or capture a moving subject more dynamically by slowing the shutter speed.

1 Press the shutter button halfway.

- This displays the aperture value and shutter speed value on the recording screen. (Approx. 10 seconds)

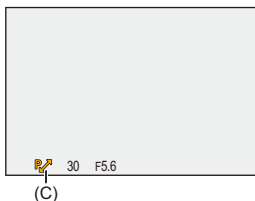

2 Rotate or while the values are displayed.

- This displays the Program Shift icon (C) on the recording screen.



3 Start recording.

Canceling Program Shift

- Set the camera on/off switch to [OFF].
- Rotate  or  until the Program Shift icon disappears.



- Program Shift is not available when using the following function:
 - Flash



- You can customize dial operations:
 - (→ [\[Dial Set.\]: 644](#))
- The recording screen can display an exposure meter indicating the relationship between aperture value and shutter speed:
 - (→ [\[Expo.Meter\]: 653](#))

Aperture-Priority AE Mode



In [A] mode (Aperture-Priority AE mode), you can set the aperture value before recording.

The shutter speed will be automatically set by the camera.



Smaller aperture values

It becomes easier to defocus the background.



Larger aperture values

It becomes easier to bring everything into focus including the background.

1 Set the recording mode to [A].

- Set the mode dial. (→ [Selecting the Recording Mode: 82](#))

2 Set the aperture value.

- Rotate  or .

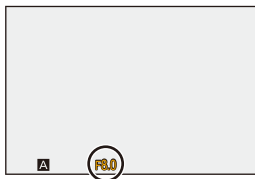
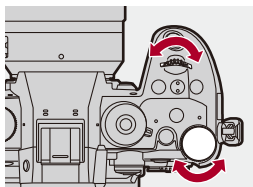

3 Start recording.

- If the correct exposure is not achieved when the shutter button is pressed halfway, the aperture value and the shutter speed blink red.

❖ Depth of Field Characteristics

Aperture value	Small	Large
Focal length of lens	Telephoto	Wide-angle
Distance to subject	Near	More distant
Depth of field (area in sharp focus)	Shallow (narrow) Example: When you want to take a image with a defocused background.	Deep (wide) Example: When you want to take a image with focus as far as the background.



- The effects of the set aperture value and shutter speed will not be visible on the recording screen.

To check the effects on the recording screen, use [Preview]. (→ [Preview Mode: 320](#))

You can set the preview of the aperture effect to constantly operate in [A] mode to check the depth of field while recording:

(→ [\[Constant Preview\]: 647](#))

- The brightness of the recording screen and of actual recorded images may differ. Check the images on the playback screen.
- When using a lens with an aperture ring, set the position of the aperture ring to other than [A] to use the aperture value of the lens.



- You can customize dial operations:

(→ [\[Dial Set.\]: 644](#))

- The recording screen can display an exposure meter indicating the relationship between aperture value and shutter speed:

(→ [\[Expo.Meter\]: 653](#))

- When a supported lens is being used, stops for setting the aperture value with the aperture ring can be changed:

(→ [\[Aperture Ring Increment\]: 665](#))

Shutter-Priority AE Mode



In [S] mode (Shutter-Priority AE mode), you can set the shutter speed before recording.

The aperture value will be automatically set by the camera.



Slower shutter speeds

It becomes easier to capture motion



Faster shutter speeds

It becomes easier to freeze motion

1 Set the recording mode to [S].

- Set the mode dial. (→ [Selecting the Recording Mode: 82](#))

2 Set the shutter speed.

- Rotate  or .

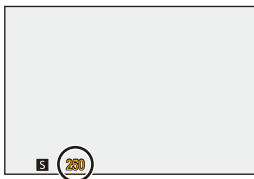
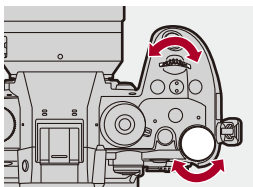

3 Start recording.

- If the correct exposure is not achieved when the shutter button is pressed halfway, the aperture value and the shutter speed blink red.



- The effects of the set aperture value and shutter speed will not be visible on the recording screen.
To check the effects on the recording screen, use [Preview]. (→ [Preview Mode: 320](#))
- The brightness of the recording screen and of actual recorded images may differ.
Check the images on the playback screen.
- Shutter speeds faster than 1/250 of a second are not available when recording using a flash. (→ [Shutter Speeds for Flash Modes: 380](#))



- You can customize dial operations:
(→ [\[Dial Set.\]: 644](#))
- The recording screen can display an exposure meter indicating the relationship between aperture value and shutter speed:
(→ [\[Expo.Meter\]: 653](#))

Manual Exposure Mode

- Available Shutter Speeds (Sec.): 318
- [B] (Bulb): 319



In [M] mode (Manual Exposure mode), you can record by manually setting the aperture value and shutter speed.

In default settings, the ISO sensitivity is set to [AUTO].



As a result, the ISO sensitivity will be adjusted according to the aperture value and shutter speed.

Exposure compensation can also be used when ISO sensitivity is set to [AUTO].

1 Set the recording mode to [M].

- Set the mode dial. (→ [Selecting the Recording Mode: 82](#))

2 Set the aperture value and shutter speed.

- Rotate  to set the aperture value (A), and  to set the shutter speed (B).

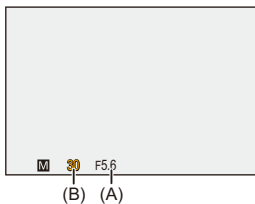
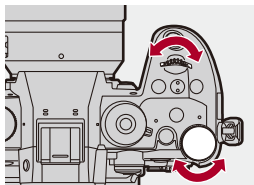

3 Start recording.

- If the correct exposure is not achieved when the shutter button is pressed halfway, the aperture value and the shutter speed blink red.

❖ Manual Exposure Assist

When ISO sensitivity is set to other than [AUTO], Manual Exposure Assist (example: **MM+1**) will be displayed on the recording screen.

You can check the difference between the current exposure value and the standard exposure (± 0) measured by the camera.

- Use Manual Exposure Assist as a guide.

We recommend checking the images on the playback screen when recording.

Available Shutter Speeds (Sec.)

- **[MECH.]**

[B] (Bulb, max. approx. 30 minutes), 60 to 1/8000

- **[EFC]**

[B] (Bulb, max. approx. 30 minutes), 60 to 1/2000

- **[ELEC.]**

[B] (Bulb, max. approx. 60 seconds), 60 to 1/32000



- The effects of the set aperture value and shutter speed will not be visible on the recording screen.

To check the effects on the recording screen, use [Preview]. (→ [Preview Mode: 320](#))

You can set the preview of the aperture effect and the shutter speed effect to constantly operate in [M] mode to check the depth of field and movement of the subject while recording:

(→ [\[Constant Preview\]: 647](#))

- The brightness of the recording screen and of actual recorded images may differ. Check the images on the playback screen.
- When using a lens with an aperture ring, set the position of the aperture ring to other than [A] to use the aperture value of the lens.
- Shutter speeds faster than 1/250 of a second are not available when recording using a flash. (→ [Shutter Speeds for Flash Modes: 380](#))



- You can customize dial operations:

(→ [\[Dial Set.\]: 644](#))

- The recording screen can display an exposure meter indicating the relationship between aperture value and shutter speed:

(→ [\[Expo.Meter\]: 653](#))

[B] (Bulb)

If you set the shutter speed to [B] (Bulb), the shutter stays open while the shutter button is pressed fully. (up to approx. 30 minutes)

The shutter closes when the shutter button is released.

Use this when you want to keep the shutter open for a long time to record images of fireworks, night scenery or a starry sky.



- We recommend using a tripod or the Shutter Remote Control (DMW-RS2: optional) during bulb recording.
- Bulb recording may create noticeable noise.

If you are concerned about noise, we recommend that you set [Long Exposure NR] (→ [Long Exposure NR]: 287) to [ON] in the [Photo] ([Image Quality]) menu before recording.



- Bulb is not available when using the following functions:
 - SH burst recording
 - [Time Lapse Shot]
 - [Stop Motion Animation] (when set to [Auto Shooting])
 - High Resolution mode
 - [Bracketing]
 - [Live View Composite]

Preview Mode



You can check the effects of aperture on the recording screen by physically closing the aperture blades of the lens to the aperture value set for actual recording.

In addition to the effects of aperture, you can check the effects of shutter speed at the same time.

- You can also perform the same operation by pressing the Fn button registered with [Preview]. (→ [Fn Buttons: 597](#))

Press the preview button.

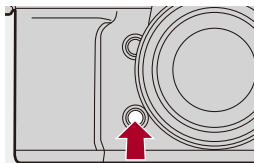

- Each press of the button switches between the effect preview screens.

Aperture effect: OFF

Shutter speed effect: OFF



Aperture effect: ON

Shutter speed effect: OFF



Aperture effect: ON

Shutter speed effect: ON



- It is possible to record in preview mode.
- Range for shutter speed effect check is 8 seconds to 1/32000 of a second.
- Depending on the [Constant Preview] setting, there are preview screens that cannot be displayed.



- You can always confirm the effects of aperture on the recording screen when in [A]/[M] mode:
(→ [\[Constant Preview\]: 647](#))
- You can assign the function that enables you to view the aperture effect just while the button is being pressed to an Fn button:
(→ [\[Preview Aperture Effect\]: 607](#))

Exposure Compensation

- [i.Dynamic Range]: 325



You can compensate the exposure when the standard exposure determined by the camera is too bright or too dark.

You can adjust the exposure in 1/3 EV steps in a range of ± 5 EV.

When recording videos, the range changes to ± 3 EV.

- 1 Press [].

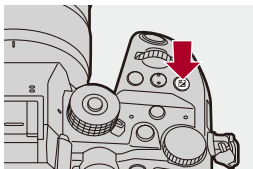

2 Compensate the exposure.

- Rotate , , or .

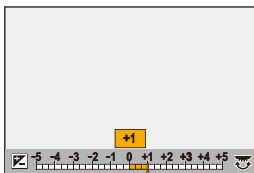
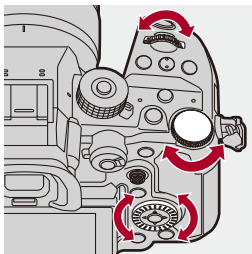

3 Confirm your selection.

- Press the shutter button halfway.



- In [M] mode, you can compensate the exposure by setting the ISO sensitivity to [AUTO].
- When the exposure compensation value falls below or exceeds ± 3 EV, the brightness of the recording screen will no longer change.
Press the shutter button halfway or use AE Lock to reflect the value on the recording screen.
- The set exposure compensation value is stored even if you turn off the camera.



- The standard value for standard exposure can be adjusted:
(→[Exposure Offset Adjust.]: 630)
- You can set the exposure compensation value to be reset when the camera is turned off:
(→[Exposure Comp. Reset]: 632)
- You can change the operation of the [] button:
(→[WB/ISO/Expo. Button]: 643)
- Exposure Bracket can be set and flash output can be adjusted on the exposure compensation screen:
(→[Exposure Comp. Disp. Setting]: 643)
- You can assign the function that matches the aperture value and shutter speed to the standard exposure to an Fn button:
(→[One Push AE]: 603)

[i.Dynamic Range]



Contrast and exposure are compensated when the brightness difference between the background and subject is great.

→ / → → **Select [i.Dynamic Range]**

Settings: [AUTO]/[HIGH]/[STANDARD]/[LOW]/[OFF]



- Compensation effect may not be achieved depending on the recording conditions.
- When the following functions are being used, [i.Dynamic Range] is not available:
 - [Like709]/[V-Log]/[ARRI LogC3]/[REAL TIME LUT]/[Hybrid Log Gamma] ([Photo Style])
 - [Filter Settings]
 - [Live View Composite]

Locking Focus and Exposure (AF/AE Lock)



Lock the focus and exposure in advance to take pictures with the same focus and exposure settings while changing the composition.

This is useful when you want to bring an edge of the screen into focus or there is a backlight, for example.

1 Register [AE LOCK], [AF LOCK], or [AF/AE LOCK] to the Fn button. (→ [Fn Buttons: 597](#))

- These cannot be registered to [Fn4] to [Fn8].

[AE LOCK]

The exposure is locked.

[AF LOCK]

The focus is locked.

[AF/AE LOCK]

Both focus and exposure are locked.

2 Lock focus and exposure.

- Press and hold the Fn button.
- If focus is locked, then the AF lock icon (A) will be displayed.
- If exposure is locked, then the AE lock icon (B) will be displayed.

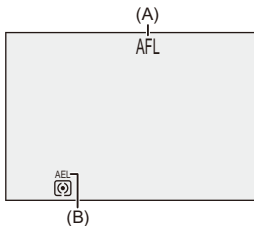

3 Hold the Fn button to decide on the composition and then perform recording.

- Press the shutter button fully.



- Program Shift can be set even when AE is locked.



- You can maintain lock even without pressing and holding the Fn button:
(→ [\[AF/AE Lock Hold\]: 634](#))
- You can make fine manual adjustments to the focus during AF Lock:
(→ [\[AF+MF\]: 635](#))

ISO Sensitivity

- [ISO Sensitivity (photo)]: 332





You can set light sensitivity (ISO sensitivity).

With the default settings, you can set in the range between 100 and 25600 (between 100 and 12800 in [M] mode) in 1/3 EV increments.

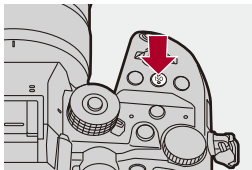
1 Press [ISO].



2 Select ISO sensitivity.

- Rotate , , or .
- Selection is also possible by pressing [ISO].

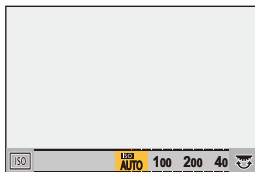
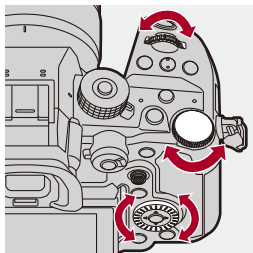

3 Confirm your selection.

- Press the shutter button halfway.



Characteristics of the ISO Sensitivity

By increasing the ISO sensitivity, the shutter speed can be increased in dark places to prevent camera shake and subject blur. However, higher ISO sensitivities also increase the amount of noise in the recorded images.

❖ Setting Items (ISO Sensitivity)

[AUTO]

The ISO sensitivity is automatically adjusted according to the brightness.

- Taking picture: Maximum [3200]^{*1}
 - Video recording:
 - Maximum [6400]^{*2} (sensor output 60 fps or lower)
 - Maximum [3200]^{*3} (sensor output 61 fps or higher)
-

[100]^{*4} to [25600]

In [M] mode:

[100]^{*4} to [12800] (sensor output 60 fps or lower)

[100]^{*4} to [3200]^{*5} (sensor output 61 fps or higher)

The ISO sensitivity is fixed at the selected value.

*1 Default setting. The upper limit can be changed with [ISO Sensitivity (photo)].

*2 Default setting. The upper limit can be changed with [ISO Sensitivity (video)].

*3 Default setting. When [Extended ISO] is set to [ON], the upper limit can be set to [6400] with [ISO Sensitivity (video)].

*4 By setting [Extended ISO] (→[Extended ISO]: 629) to [ON] in the [Custom] ([Image Quality]) menu, the ISO sensitivity can be extended to a lower limit of [50].

*5 By setting [Extended ISO] (→[Extended ISO]: 629) to [ON] in the [Custom] ([Image Quality]) menu, the ISO sensitivity can be extended to an upper limit of [12800].

- When the following functions are being used, the ISO sensitivity that can be set is restricted.
 - High Resolution mode: Up to an upper limit of [1600]
 - [Filter Settings]: Up to an upper limit of [3200]
 - [Like709] ([Photo Style]): Down to a lower limit of [100]
 - [V-Log] ([Photo Style]):
 - Picture: Down to a lower limit of [500], up to an upper limit of [12800]
(The lower limit changes to [125] when [Extended ISO] is set.)
 - Video: Down to a lower limit of [500] (sensor output 60 fps or lower)/[250] (sensor output 61 fps or higher)
(The lower limit changes to [125] when [Extended ISO] is set.)
 - [ARRI LogC3] ([Photo Style]): Down to a lower limit of [320] (sensor output 60 fps or lower)/[160] (sensor output 61 fps or higher)
 - [Hybrid Log Gamma] ([Photo Style]): Down to a lower limit of [250]
 - [Live View Composite]: Up to an upper limit of [1600]
- When [Photo Style] is set to [REAL TIME LUT], the range of ISO sensitivity levels you can use depends on the base Photo Style of the applied LUT file.



- You can set upper and lower limits for ISO Auto:
 - (→[ISO Sensitivity (photo)]: 332, [ISO Sensitivity (video)]: 412)
- You can change the intervals between ISO sensitivity settings values:
 - (→[ISO Increments]: 629)
- The setting range of ISO sensitivity can be extended:
 - (→[Extended ISO]: 629)
- You can set the lower limit for shutter speed for ISO Auto:
 - (→[Min. Shutter Speed]: 290)
- You can change the operation of the [ISO] button:
 - (→[WB/ISO/Expo. Button]: 643)
- You can set the upper limit for ISO Auto on the ISO sensitivity settings screen:
 - (→[ISO Displayed Setting]: 643)
- You can change the units for sensitivity to dB when recording video:
 - (→[SS/Gain Operation]: 450)

[ISO Sensitivity (photo)]



Sets the lower and upper limits for ISO sensitivity when ISO sensitivity is set to [AUTO].

 →  →  → **Select [ISO Sensitivity (photo)]**

[ISO Auto Lower Limit Setting]

Sets the lower limit for ISO sensitivity when ISO sensitivity is [AUTO].

- Set in the range between [100] and [12800].

[ISO Auto Upper Limit Setting]

Sets the upper limit for ISO sensitivity when ISO sensitivity is [AUTO].

- Set to [AUTO] or in the range between [200] and [25600].



- When the following function is being used, [ISO Sensitivity (photo)] is not available:
 - [Live View Composite]

White Balance / Image Quality

This chapter describes functions that enable you to record images how you imagine them, such as white balance and Photo Style.

- [White Balance \(WB\): 334](#)
- [\[Photo Style\]: 342](#)
- [\[Filter Settings\]: 356](#)
- [\[REAL TIME LUT\]: 362](#)
- [\[LUT Library\]: 364](#)
- [Lens Compensation: 370](#)

White Balance (WB)

- [Adjusting the White Balance: 340](#)



White balance (WB) is a function that corrects the color cast produced by the light illuminating the subject.

It corrects the colors so that white objects appear in white to make the overall color closer to what is seen by the eye.



Normally, you can use auto ([AWB], [AWBc] or [AWBw]) to obtain the optimal white balance.

Set this function when the coloring of the image is different from what you expected, or you want to change the coloring to capture the ambience.

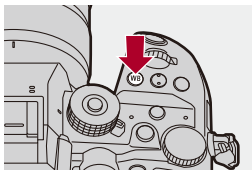
1 Press [WB].



2 Select the white balance.

- Rotate ,  or .
- Selection is also possible by pressing [WB].

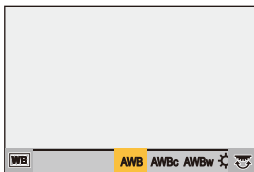
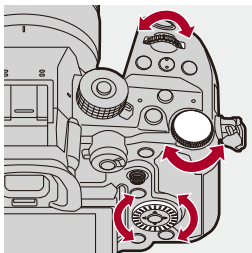

3 Confirm your selection.

- Press the shutter button halfway.

Setting Items (White Balance)

[AWB]

Auto

[AWBc]

Auto (Reduces the reddish hue under an incandescent light source)

[AWBw]

Auto (Leaves the reddish hue under an incandescent light source)

]

Clear sky

]

Cloudy sky

]

Shade under a clear sky

]

Incandescent light

]

Flash

] to [

Set mode 1 to 4 (→ [Registering the White Set: 339](#))

] to [

Color temperatures 1 to 4 (→ [Color Temperature Setting: 339](#))

* It operates as [AWB] during video recording.

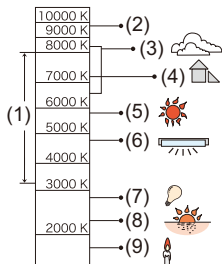

(1) [AWB] will work within this range.

(2) Blue sky

(3) Cloudy sky (Rain)

(4) Shade

(5) Sunlight

(6) White fluorescent light

(7) Incandescent light bulb

(8) Sunrise and sunset

(9) Candlelight

K=Kelvin Color Temperature



- Under lighting such as fluorescent or LED lighting, the appropriate white balance will vary depending on the lighting type.

Use [AWB], [AWBc], [AWBw] or [] to [].



- The white balance is fixed to [AWB] while [Filter Settings] is being used.



- It is possible to temporarily lock auto white balance:





(→[\[AWB Lock Setting\]: 631](#))

- You can change the operation of the [WB] button:

(→[\[WB/ISO/Expo. Button\]: 643](#))







❖ Registering the White Set

Take pictures of a white object under the light source of the recording location to adjust the white balance until it appears white.

- 1 Press [WB] and then select any value from [] to [].
- 2 Press ▲.
- 3 Aim the camera at a white object so that it appears inside the frame at the center of the screen and then press  or .
 - This will set the white balance and return you to the recording screen.

❖ Color Temperature Setting

Set the numeric value for the white balance color temperature.

- 1 Press [WB] and then select any value from [] to [].
- 2 Press ▲.
 - The color temperature setting screen is displayed.
- 3 Press ▲▼ to select the color temperature and then press  or .
 - You can set the White Balance Bracket (Color Temperature) by rotating ,  or . (→ [\[More Settings\] \(White Balance Bracket \(Color Temperature\)\)](#): 276)



- You can set a color temperature from [2500K] to [10000K].
- In [] mode or when [Video-Priority Display] in the [Custom] ([Monitor / Display (Video)]) menu is set to [ON], the kelvin values are displayed on the recording screen.

Adjusting the White Balance

You can adjust the coloring even when the coloring you want to apply is not produced by the selected white balance.

- 1 Press [WB].
- 2 Select the white balance and then press ▼.

- The adjustment screen is displayed.

- 3 Adjust the coloring.

- ◀: [A] (AMBER: ORANGE)
- ▲: [G] (GREEN: GREENISH)
- ▶: [B] (BLUE: BLUISH)
- ▼: [M] (MAGENTA: REDDISH)

- You can also make adjustments in diagonal directions by using the joystick.
- You can also touch the graph to make adjustments.
- Press [DISP.] to return to the unadjusted state.
- You can set the White Balance Bracket by rotating 🌄, 🌑 or ⚙️.
(→[More Settings] (White Balance Bracket): 276)

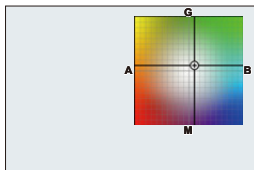

4 Confirm your selection.

- Press the shutter button halfway.



- When the white balance is adjusted, the color of its recording screen icon changes to the adjusted color.

Adjusting toward the [G] side will display [+], while adjusting toward the [M] side will display [-].

[Photo Style]



You can select the finishing settings of images to suit your subjects and expression styles.

The image quality can be adjusted for each Photo Style.

You can also apply the LUT file you have loaded in the camera and record pictures and videos.

MENU → [**📷**]/[**👤**] → [**⚙️**] → **Select [Photo Style]**



STD. [Standard]

The standard setting.

VIVID [Vivid]

A setting that produces a more vivid quality with higher saturation and contrast.

NAT [Natural]

A setting that produces a softer quality with lower contrast.

L.CLAS N [L.ClassicNeo]

A setting for a film-like effect that has a nostalgic, soft coloring.

 **[Flat]**

A setting that produces a flatter image quality with lower saturation and contrast.

 **[Landscape]**

A setting suited for sceneries with vivid blue skies and greens.

 **[Portrait]**

A setting suited for portraits with a healthy and beautiful skin tone.

 **[Monochrome]**

A monochrome setting with no color shades.

 **[L.Monochrome]**

A monochrome setting with rich gradation and crisp black accents.

 **[L.Monochrome D]**

A monochrome setting that creates a dynamic impression with enhanced highlights and shadows.

 **[L.Monochrome S]**

A setting for a monochrome effect with a gentle touch suited to portraits.

 **[LEICA Monochrome]**

A setting mode that realizes Leica monochrome mode, featuring deep contrasts between black and white.

 **[Cinelike D2]**

A setting that creates a film-like finishing touch using a gamma curve and gives priority to the dynamic range.

- This function is suitable for video editing processes.
-

 **[Cinelike V2]**

A setting that creates a film-like finishing touch using a gamma curve that gives priority to the contrast.

[Like709]

A setting that minimizes overexposure by applying a gamma curve correction equivalent to Rec.709 to perform compression (knee adjustment) of high-luminance areas. (→[Recording While Controlling Overexposure \(Knee\): 410](#))

- Rec.709 is an abbreviation of “ITU-R Recommendation BT.709”, a standard for high-definition broadcasting.

[V-Log]

A gamma curve setting intended for post-production processing. (→[Log Recording: 483](#))

- It allows you to add rich gradation to images during post-production editing.

[ARRI LogC3]

A setting for log video that conforms to the EI800 gamma curve from the LogC3 specification offered by ARRI (→[Log Recording: 483](#))

- It allows the production of images rich in gradation through post-production techniques.
 - **The function can be used only when you have used the Upgrade Software Key (DMW-SFU3A: optional) and enabled the function with [Activate]. (→[\[Activate\]: 692](#))**
 - This is available in [M] mode.
 - Recording qualities that enable use of the [ARRI LogC3] (→[List of Recording Qualities That Enable Special Videos to be Recorded: 506](#))
-

LUT [REAL TIME LUT]









You can apply the LUT file that was registered in [LUT Library]. (→[\[LUT Library\]: 364](#))

- [Sample LUT1] is applied in the default setting.
- The Photo Style acting as the base is set automatically by the applied LUT file. (If there is no base Photo Style information in the LUT file, you can select [V-Log] or [ARRI LogC3].)

Use My Photo Style when you want to change the Photo Style that will act as the base.

- The Photo Style can also be changed to [REAL TIME LUT] in the recording screen by pressing the Fn button assigned with [REAL TIME LUT]. (→[\[REAL TIME LUT\]: 362](#))

Selecting the LUT file to apply

- 1 Press   to select [LUT] and then press [].
- 2 Rotate ,  or  to select the LUT file to apply, then press  or .
- 3 Press the shutter button or video rec. button to start recording.

HLG [Hybrid Log Gamma]¹

A setting used to record HLG format video. (→[HLG Videos: 492](#))

[MY PHOTO STYLE 1]² to [MY PHOTO STYLE 10]²

Adjusts the image quality of Photo Style items to your preferred settings and registers these as My Photo Style items. (→ [Registering Settings in My Photo Style: 355](#))

- Effects up to [MY PHOTO STYLE 4] are displayed with the default settings.



Applying a LUT file

With image quality adjustments, you can apply up to 2 LUT files registered in the [LUT Library]. (→ [\[LUT Library\]: 364](#))

- When applying 2 LUT files, the images with LUT1 applied have LUT2 applied.
- The Photo Style will be the base Photo Style of the applied LUT file (LUT1 if 2 LUT files are applied).

When applying a LUT file created with image editing software, select the [Photo Style] that is the same as the Photo Style used as the base when creating it.

When you select a different [Photo Style], the images may not be displayed or recorded correctly.

- [ MY] switches to [ LUT] when [LUT1] or [LUT2] is applied in image quality adjustments.

*1 Can only be selected when in the [ M] mode and set to a 10-bit [Rec Quality]. (→ [\[Rec Quality\]: 142](#))

*2 You can set the items to display in the menu with [Show/Hide Photo Style] in [Photo Style Settings]. (→ [\[Photo Style Settings\]: 628](#))



- In [iA] mode, operation differs from that in other recording modes.
 - [Standard] or [Monochrome] can be set.
 - The setting will be reset to [Standard] when the camera is switched to another recording mode or it is turned off.
 - Image quality cannot be adjusted.
- The range of available ISO sensitivities is different when [Photo Style] is set to the following (→ [Setting Items \(ISO Sensitivity\): 330](#)):
 - [Like709]/[V-Log]/[ARRI LogC3]/[REAL TIME LUT] (base Photo Style is [V-Log]/[ARRI LogC3])/[Hybrid Log Gamma]
- You can set the knee mode with [Like709]. (→ [Recording While Controlling Overexposure \(Knee\): 410](#))
- When [LUT] is set to [OFF] in the image quality adjustments of [REAL TIME LUT], [Photo Style] will operate the same as the Photo Style that acts as the base.
- When [Filter Settings] is being used, [Photo Style] is not available.



- You can make detailed Photo Style settings:
(→ [My Photo Style Settings: 628](#))

❖ Adjusting Image Quality

- 1 Press ◀▶ to select the type of Photo Style.
- 2 Press ▲▼ to select an item and then press ◀▶ to adjust.
 - Adjusted items are indicated with [*].

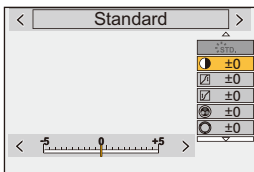

- 3 Press **MENU/SET** or .
 - When the image quality is adjusted, the Photo Style icon on the recording screen is indicated with [*].

Settings Items (Image Quality Adjustment)

[Contrast]

Adjusts the contrast in the image.

[Highlight]

Adjusts the brightness of bright areas.

[Shadow]

Adjusts the brightness of dark areas.

[Saturation]

Adjusts the vividness of colors.

[Color Tone]

Adjusts blue and yellow tints.

 [Hue]

Assuming that the reference point is red, this rotates the hue toward violet/magenta or yellow/green to adjust the coloring of the entire image.

 [Filter Effect]

[Yellow]: Enhances the contrast. (Effect: weak) Records the sky with a clear blue.

[Orange]: Enhances the contrast. (Effect: medium) Records the sky with a darker blue.

[Red]: Enhances the contrast. (Effect: strong) Records the sky with a much darker blue.

[Green]: Skin and lips of people appear in natural tones. Green leaves appear brighter and more enhanced.

[Off]

 [Grain Effect]

[Low]/[Standard]/[High]: Sets the grain effect level.

[Off]

 [Color Noise]

[On]: Adds color to the grain effect.

[Off]

 [Sharpness]

Adjusts the outlines in the image.

NR [Noise Reduction]

Adjusts the noise reduction effect.



- Increasing the effect may cause a slight drop in picture resolution.
-

ISO[Sensitivity]^{*3}

Sets the ISO sensitivity. (→ [ISO Sensitivity: 328](#))





WB[White Balance]^{*3}

Sets the white balance. (→ [White Balance \(WB\): 334](#))

- While [WB] is selected, press [] to display the white balance setting screen.
Press [] again to return to the original screen.
-

LUT **LUT1** **LUT2** [LUT]



Applies the preset or the LUT file that was registered in [LUT Library]. (→ [\[LUT Library\]: 364](#))

- 1 Select either [REAL TIME LUT] or one of [MY PHOTO STYLE 1] to [MY PHOTO STYLE 10] in [Photo Style].
 - 2 Press ▲▼ to select [LUT] and then press [].
 - 3 Rotate  to select the LUT file to apply, then press  or .
-

[LUT Opacity]

Adjusts the LUT file effect.

*3 Available when the following is set while [MY PHOTO STYLE 1] to [MY PHOTO STYLE 10] are selected:

[] → [] → [Photo Style Settings] → [My Photo Style Settings] → [Add Effects] → [Sensitivity]/[White Balance] → [ON]

- The items that you can adjust the image quality for depend on the Photo Style type.

	✓	✓	✓			✓*4
	✓	✓	✓			✓*4
	✓	✓	✓			✓*4
 ([Saturation])	✓	✓		✓		✓
 ([Color Tone])			✓			
	✓	✓		✓		
			✓			
		✓	✓			✓
		✓*5				✓*4, 5
	✓	✓	✓	✓	✓	✓
	✓	✓	✓	✓	✓	✓
 	✓*6	✓*6	✓*6	✓*6	✓*6	✓

- *4 Adjustment may not be possible depending on the base Photo Style.
- *5 Can be set when [Grain Effect] is one of [Low], [Standard], or [High].
- *6 You can set up to 2 LUT files when the [Photo Style] is My Photo Style.



- The effects of [Grain Effect] and [Color Noise] cannot be checked on the recording screen.
- [LUT] cannot be applied to RAW images. When [Picture Quality] is set to [RAW] for recording, a LUT file can be applied only to the live view and thumbnail displays in the playback screen.
- [Grain Effect] and [Color Noise] are not available when using the following function:
 - Video recording

❖ Range Properties When Recording with a LUT File Applied

The following table shows the range properties for videos recorded with LUT files applied in Photo Style:

(A) MP4

(B) MOV

(C) Apple ProRes 422HQ/422

Base Photo Style of [REAL TIME LUT]/ My Photo Style	LUT file applied	[Rec. File Format]			[Luminance Level]	Range property
		(A)	(B)	(C)		
[V-Log]	[Vlog_709]	✓	✓		Fixed to [16-255] ([64-1023])	⇒ Video range
				✓	Fixed to [16-235] ([64-940])	⇒ Video range
	Other than [Vlog_709]	✓	✓		Fixed to [0-255] ([0-1023])	⇒ Full range
				✓	Fixed to [16-235] ([64-940])	⇒ Video range
[ARRI LogC3]/ [Hybrid Log Gamma]	All	✓	✓	✓	Fixed to [64-940]	⇒ Video range
Other than the above	All				[0-255]([0-1023])	⇒ Full range
		✓	✓		[16-235]([64-940])/	⇒ Video range
				✓	[16-255]([64-1023])	⇒ Video range
			✓	Fixed to [16-235] ([64-940])	⇒ Video range	



- When editing video with image editing software, we recommend using LUT files for full range.
- When generating LUT files from recorded video files using image editing software, we recommend using video files recorded with [Luminance Level] set to [0-255] ([0-1023]) or [16-235] ([64-940]).
- Use LUT files for full range when recording pictures.
If you record with a LUT file for video range applied, it may not be possible to properly display or record the images.
- If there is a difference between the range property of the applied LUT file and the range property of the video file, it may not be possible to generate the images properly in the image editing software.
When loading the video files into the image editing software, select the correct range setting for each video file.
- The results of recording images with LUT files applied with this camera and the results of applying LUT files with image editing software will not match completely.

❖ Registering Settings in My Photo Style



- 1 Press ◀▶ to select the type of Photo Style.
- 2 Adjust the image quality.
 - My Photo Style displays the types of Photo Style at the top of image quality adjustment.
Select the base Photo Style.
- 3 Press [DISP.].
- 4 (When [MY PHOTO STYLE 1] to [MY PHOTO STYLE 10] is selected)
Press ▲▼ to select [Save Current Setting] and then press or .
- 5 Press ▲▼ to select the registration destination number and then press or .

 - A confirmation screen will be displayed.
On the confirmation screen, press [DISP.] to change the My Photo Style name.
Up to 22 characters may be entered. Double-byte characters are treated as 2 characters.
How to enter characters (→ [Entering Characters: 108](#))

❖ Changing the Registered Contents of My Photo Style

- 1 Select any value from [MY PHOTO STYLE 1] to [MY PHOTO STYLE 10].
- 2 Press [DISP.] and then set the item.

[Load Preset Setting]

[Save Current Setting]

[Edit Title]

[Restore to Default]

[Filter Settings]

- [Simultaneous Record w/o Filter]: 361



This mode records with additional image effects (filters).

You can adjust the effect for each filter.



In addition, you can simultaneously take pictures without effects.

1 Set the [Filter Effect].

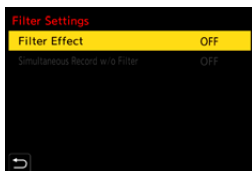
-  → [] / [] → [] → [Filter Settings] → [Filter Effect] → [SET]



2 Select the filter.

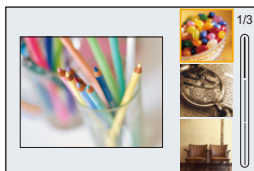

- Press ▲▼ to select, and then press  or .
- You can also select the image effect (filter) by touching the sample picture.
- Press [DISP.] to switch the screen in the order of normal display and guide display.

The guide display shows the description of each filter.



❖ Adjusting the Filter Effect

You can adjust the filter effect.

- 1 Select the filter.
- 2 On the recording screen, press [WB].
- 3 Rotate ,  or  to set.
 - To return to the recording screen, press [WB] again.
 - When the filter effect is adjusted, the filter icon on the recording screen is indicated with [*].





Filter	Items that can be adjusted
[Expressive]	Vividness
[Retro]	Coloring
[Old Days]	Contrast
[High Key]	Coloring
[Low Key]	Coloring
[Sepia]	Contrast
[Cross Process]	Coloring
[Bleach Bypass]	Contrast

❖ Setting a Filter with Touch Operation



- The default settings are for the Touch Tab to not be displayed.
Set [Touch Tab] to [ON] in [Touch Settings] in the [Custom] ([Operation]) menu.
(→[Touch Settings]: 640)

- 1 Touch [].
- 2 Touch the item to set.
[]: Filter on/off
[EXPS]: Filter
[]: Filter effect adjustment





- White balance will be fixed to [AWB] and the flash will be fixed to [] (Forced Flash Off).
- The upper limit to ISO sensitivity is [3200].
- Depending on the filter, the recording screen may seem as if frames are missed.
- [Filter Effect] is not available when using the following function:
 - High Resolution mode
 - [Live View Composite]
 - [Live Cropping]







- When displaying the [Filter Effect] setting screen using the Fn button, pressing [DISP.] displays the filter selection screen.

[Simultaneous Record w/o Filter]



You can simultaneously take pictures with no added filter effects.

 → []/[] → [] → [Filter Settings] → Select
[Simultaneous Record w/o Filter]

Settings: [ON]/[OFF]



- [Simultaneous Record w/o Filter] is not available when using the following functions:
 - Burst recording
 - [Time Lapse Shot]
 - [Stop Motion Animation]
 - [RAW+FINE]/[RAW+STD.]/[RAW] ([Picture Quality])
 - [Bracketing]

[REAL TIME LUT]



Set the Photo Style to [REAL TIME LUT] and apply a LUT file.





1 Register [REAL TIME LUT] to the Fn button. (→Fn Buttons: 597)

2 Display the LUT file selection screen.

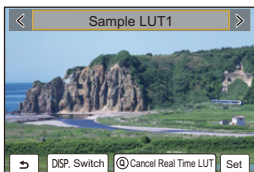
- Press the Fn button set in Step **1**.
- When setting up initially, etc., after purchase, the QR code that takes you to the site for downloading “LUMIX Lab” may be displayed.

3 Select the LUT.



- Press ◀▶ to select, and then press .
- You can also select by rotating ,  or .
- The LUT file list is displayed when you press [DISP.].
- You can apply the LUT file that was registered in the [LUT Library]. (→[LUT Library]: 364)
- [Sample LUT1] is applied in the default setting.
-  V-Log is displayed on the recording screen when a LUT file has not been applied.
- To cancel Real Time LUT, press [Q].

[LUT Library]

- [Base Photo Style of LUT files: 368](#)



Register LUT files to the camera to use with Photo Style and LUT View Assist.

Using the “Panasonic LUMIX Lab” smartphone app, you can register LUT files on the smartphone in the [LUT Library] on the camera. (→ [LUT Library Operations: 723](#))



- The following LUT file can be used:
 - The “.vlt” format, which meets the requirements specified in the “VARICAM 3DLUT REFERENCE MANUAL Rev.1.0”
 - The “.cube” format
- The “.cube” format LUT files are compatible with 2-point to 33-point 3D LUT.
- We recommend loading LUT files for full range onto the camera. If the range property is different, the images may not be displayed or recorded correctly.
- The number of characters that can be used in a file name differs depending on the file system of the card.
(Use alphanumeric characters for the file name)
FAT32 (SD memory card/SDHC memory card): Up to 8 characters (excluding extension).
- **exFAT (CFexpress card/SDXC card):** Up to 255 characters (including extension).
- Save the LUT file with a file extension of “.vlt” or “.cube” in the root directory of the card (the folder opened when the card is opened on a PC).



1 Insert a card on which a LUT file is saved into the camera.

2 Select [LUT Library].

-  → [] → [] → [LUT Library]





3 Select the registration destination.

- Press ▲▼ to select, and then press  or .
- If you select a registered item, the LUT file will be registered by overwriting.



4 Select [Load].

- Press  or .
- You can change the display order of LUT files by selecting [Sorting].
- You can change the registered name of LUT files by selecting [Edit Title].
- The registered LUT file is deleted when you select [Delete].

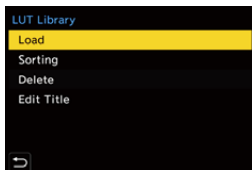

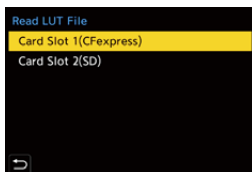

5 Select [Card Slot 1(CFexpress)] or [Card Slot 2(SD)].

- Press  or .



6 Select the LUT file to load.

- Press ▲▼ to select, and then press  or .

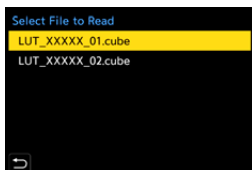

- The default setting is for [Vlog_709]/[ARRI 709]* and 3 sample LUTs to be registered.
 - * [ARRI 709] can be used only when you have used the Upgrade Software Key (DMW-SFU3A: optional) and enabled the function with [Activate].
(→[Activate]: 692)
- Up to 39 LUT files can be registered.
- [Sorting] and [Delete] are not possible with [Vlog_709]/[ARRI 709].
- [Sorting] and [Delete] are possible with the sample LUTs, but the default settings are restored when [Reset] is performed.
- With LUT files that have the Photo Style information (base Photo Style) set at the time of creation (".cube" format only), the base Photo Style icon is displayed.

Base Photo Style of LUT files

With Real Time LUT, the Photo Style information (base Photo Style) set in the LUT file is recognized to determine the Photo Style.

You can add the base Photo Style information to the LUT files (".cube" format only) you create yourself. Open the LUT file with a text editor and insert the Photo Style information under the title line.

- If there is a feature for selecting the character code in the text editor, select UTF-8.

For example: LUT file (".cube" format)

```
TITLE "Generated by Resolve"  
#LUMIXPHOTOSTYLE STD (A)  
LUT_3D_SIZE 33 (B)  
LUT_3D_SIZE 33 (C)  
  
0.0170596 0.0150607 0.014023  
0.0183261 0.0162356 0.0151827  
...
```

(A) Photo Style information

(B) Identifier tag

(C) Photo Style tag

- A half-width space is required between the identifier tag and the Photo Style tag.
- If the Photo Style information is absent or if it is not set correctly, [V-Log] is used as the base Photo Style.

List of Photo Style Information

- #LUMIXPHOTOSTYLE STD: [Standard]
- #LUMIXPHOTOSTYLE VIVD: [Vivid]
- #LUMIXPHOTOSTYLE NAT: [Natural]
- #LUMIXPHOTOSTYLE LCLASN: [L.ClassicNeo]
- #LUMIXPHOTOSTYLE FLAT: [Flat]
- #LUMIXPHOTOSTYLE LAND: [Landscape]
- #LUMIXPHOTOSTYLE PORT: [Portrait]
- #LUMIXPHOTOSTYLE MONO: [Monochrome]
- #LUMIXPHOTOSTYLE LMONO: [L.Monochrome]
- #LUMIXPHOTOSTYLE LMONOD: [L.Monochrome D]
- #LUMIXPHOTOSTYLE LMONOS: [L.Monochrome S]
- #LUMIXPHOTOSTYLE LEICAMONO: [LEICA Monochrome]
- #LUMIXPHOTOSTYLE CNED2: [Cinelike D2]
- #LUMIXPHOTOSTYLE CNEV2: [Cinelike V2]
- #LUMIXPHOTOSTYLE 709L: [Like709]
- #LUMIXPHOTOSTYLE HLG: [HLG]
- #LUMIXPHOTOSTYLE VLOG: [V-Log]
- #LUMIXPHOTOSTYLE LOGC3: [ARRI LogC3]

Lens Compensation

- [Vignetting Comp.]: 370
- [Diffraction Compensation]: 371

[Vignetting Comp.]



When the screen periphery darkens as a result of the lens characteristics, you can record pictures with the brightness of the screen periphery corrected.

 →  /  →  → **Select [Vignetting Comp.]**

Settings: [ON]/[OFF]



- Compensation effect may not be achieved depending on the recording conditions.
- Noise in the periphery of the picture may stand out with higher ISO sensitivity.

[Diffraction Compensation]



The camera raises the image resolution by correcting the blurriness caused by diffraction when the aperture is closed.

 → []/[] → [] → **Select [Diffraction Compensation]**

Settings: [AUTO]/[OFF]



- Compensation effect may not be achieved depending on the recording conditions.
- Noise may stand out with higher ISO sensitivity.

Flash

If you attach the Flash (DMW-FL580L/DMW-FL360L/DMW-FL200L: optional) to the hot shoe, you can record using the flash.

You can also use a commercially available external flash by connecting a synchro cable to the flash synchro socket.

Furthermore, by attaching an external flash that supports wireless flash recording, you can wirelessly control an external flash that is in a position separate from the camera.

- Please also refer to the operating instructions for the Flash.

- [Using an External Flash \(Optional\): 373](#)
- [Setting Flash: 377](#)
- [Recording Using a Wireless Flash: 386](#)

Using an External Flash (Optional)

- [Removing the Hot Shoe Cover: 374](#)



- Remove the lens hood to prevent vignetting.
- Flash recording is not possible when the following functions are being used:
 - [ELEC.]/[Silent Mode]
 - High Resolution mode
 - [Filter Settings]
 - SH burst recording

Removing the Hot Shoe Cover

Before attaching the Flash (optional), remove the hot shoe cover. Refer to the operating instructions for the Flash for details about how to attach it.

Remove the hot shoe cover by pulling it in the direction indicated by arrow.

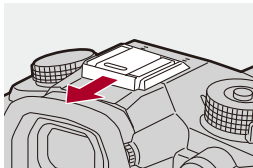

❖ Connecting a Synchro Cable to the Flash Synchro Socket

You can use a commercially available external flash by connecting a synchro cable to the flash synchro socket.



- Use an external flash with a synchronization voltage of 250 V or less.
- Use a synchro cable with the length less than 3 m (9.8 feet).

- 1 Rotate the flash synchro socket cap in the direction of the arrow to remove.
 - Be careful not to lose the flash synchro socket cap.

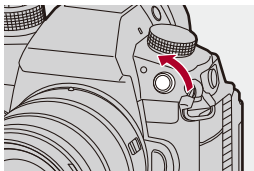

- 2 Connect the synchro cable to the flash synchro socket.
 - The socket has a lock screw to prevent the cable from falling off.
 - For the connection, refer to the operating instructions for the synchro cable.



- The flash synchro socket has no polarity. You can use a synchro cable regardless of its polarity.
- In the [P] mode, the flash synchro socket is used to synchronize time codes with an external device. (→ [Synchronizing the Time Code with an External Device: 440](#)) Do not connect an external flash to the flash synchro socket when set to the [P] mode. Doing so may cause a malfunction in the camera.

❖ Notes on Flash Recording



- Do not bring any object near the flash. Heat or light may cause the object to deform or discolor.
- If you record repeatedly, time may be needed to charge the flash.
While the flash is charging, images will be recorded without the flash firing.
- When an external flash is attached, do not carry the camera by holding only the external flash. It may become detached.
- When using a commercially available external flash, do not use one with reversed polarity or function for communicating with a camera.
It may cause the camera to malfunction, or it may not operate correctly.
- Refer to the operating instructions for the external flash for details.

Setting Flash

- [Flash Mode]: 378
- [Firing Mode]/[Manual Flash Adjust.]: 381
- [Flash Adjust.]: 383
- [Flash Synchro]: 384
- [Auto Exposure Comp.]: 385



You can set the flash function to control flash firing from the camera.

[Flash Mode]

Sets the flash mode.

 →  →  → **Select [Flash Mode]**

(Forced Flash On)/ (Forced On/Red-Eye)

The flash fires every time regardless of the recording conditions.

This is suitable for recording when there is backlighting or under lighting such as fluorescent lighting.

(Slow Sync.)/ (Slow Sync./Red-Eye)





When recording images against a nightscape, this will slow the shutter speed when the flash fires to make not only the subject but also the nightscape appear brighter.

- Slower shutter speeds may result in blurry images. To avoid this, we recommend using a tripod.
-

(Forced Flash Off)

The flash does not fire.







- The flash fires twice.
The interval between the first and second firings is longer when [] or [] is set. The subject should not move until the second firing has finished.
- [] and [] cannot be used when the following are set:
 - [Firing Mode]: [MANUAL]
 - [Flash Synchro]: [2ND]
 - [Wireless]: [ON]
- Some flash modes may not be available depending on the settings on the external flash.
- The effectiveness of red-eye reduction varies from person to person.
The effect, which is influenced by factors such as distance to the subject and whether the subject is looking at the camera when the preliminary flash is fired, may not be very noticeable in some cases.



❖ Available Flash Settings by Recording Mode

The available flash settings depend on the recording mode.

(✓: Available, —: Not available)



Recording mode	[]	[]	[ S]	[ S [Ⓢ]]	[]
[P]/[A]	✓	✓	✓	✓	✓
[S]/[M]	✓	✓	—	—	✓



- [^A] and [] can be set in [iA] mode. In [^A], the flash mode switches to one suited to the recording situation.

❖ Shutter Speeds for Flash Modes

[]/[]: 1/60 of a second* to 1/250 of a second

[S]/[]: 1 second to 1/250 of a second

* In [S] mode, this will be 60 seconds and in [M] mode it will be [B] (Bulb).

[Firing Mode]/[Manual Flash Adjust.]

You can select whether to set the flash output automatically or manually.



- The settings made here are enabled when some flashes from other manufacturers are attached.

Set on the flash when a Flash (DMW-FL580L/DMW-FL360L/DMW-FL200L: optional) is attached.

1 Set the [Firing Mode].

-  → [] → [] → [Firing Mode]



[TTL]



Sets flash output to be set automatically by the camera.

[MANUAL]

Sets the flash output manually.

- With [TTL], you can record the images you want even when recording dark scenes where the flash output tends to become greater.
 - The flash output ([1/1], etc.) is displayed on the flash icon of the recording screen.
-

2 (When set to [MANUAL]) Select [Manual Flash Adjust.] and then press  or .

3 Press   to set the flash output and then press  or .

- It can be set within the range of [1/1] (full flash output) to [1/128] in 1/3 steps.

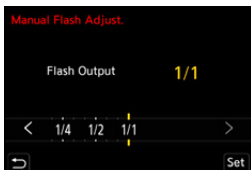

[Flash Adjust.]

You can adjust the flash output when taking pictures with the flash in TTL output mode.

1 Select [Flash Adjust.].

-  → [] → [] → [Flash Adjust.]

2 Press ◀▶ to adjust the flash output and then press or .

- It can be adjusted within the range of [-3 EV] to [+3 EV] in 1/3 EV steps.

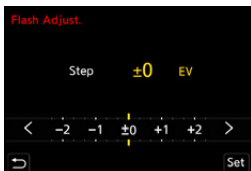

-  is displayed on the recording screen.
- For information about adjusting the flash output when recording using a wireless flash (→ [Flash Adjust.]: 390)
- [Flash Adjust.] cannot be used when the following are set:
 - [Firing Mode]: [MANUAL]
 - [Wireless]: [ON]

[Flash Synchro]

When a moving subject is recorded at night using a slow shutter and flash, a trail of light may appear in front of the subject.

If you set [Flash Synchro] to [2ND], you can take a dynamic picture with a trail of light appearing behind the subject by firing the flash immediately before the shutter closes.

 →  →  → **Select [Flash Synchro]**

[1ST]

This is the normal method for recording with the Flash.



[2ND]

The light source appears behind the subject and the picture becomes dynamic.



- When [2ND] is set, [2nd] is displayed on the flash icon of the recording screen.
- When the following functions are being used, the setting is fixed to [1ST]:
 - [Wireless]
 - [Live View Composite]
- The effect may not be adequately achieved at faster shutter speeds.

[Auto Exposure Comp.]

Automatically adjust the flash output in conjunction with the exposure compensation value. (→ [Exposure Compensation: 322](#))

 → [] → [] → **Select [Auto Exposure Comp.]**

Settings: [ON]/[OFF]

Recording Using a Wireless Flash



You can use a Flash (DMW-FL580L/DMW-FL360L/DMW-FL200L: optional) to record using a wireless flash.

You can separately control the firing of three flash groups and the flash attached to the hot shoe of the camera.

❖ Placing a Wireless Flash

Place the wireless flash with its wireless sensor facing the camera.

Placement example

When (C) is placed to erase the shadow in the background of the subject that the flash groups (A) and (B) will create

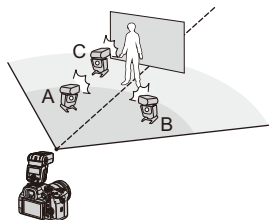



- The placement range serves as a guide for when recording with the camera held horizontally. The range differs depending on the surrounding environment.
- We recommend using a maximum of three wireless flashes in each group.
- If the subject is too close, communication light may affect the exposure. You can reduce the effect by setting [Communication Light] to [LOW] or lowering the output with a diffuser or similar device. (→[Communication Light]: 392)

1 Attach an external flash to the camera. (→[Removing the Hot Shoe Cover: 374])

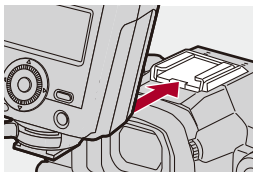

2 Set the wireless flashes to [RC] mode and then place them.

- Set the channel and group for the wireless flashes.

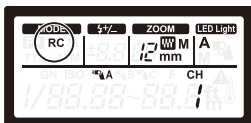

3 Enable the wireless flash function of the camera.

-  → [] → [] → [Wireless] → [ON]

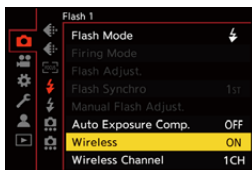

4 Set [Wireless Channel].

- Select the same channel as on the wireless flash side.



5 Set [Wireless Setup].

- Set the firing mode and flash output.



- When [Wireless] is set, [WL] is displayed on the flash icon of the recording screen.

❖ Setting Items ([Wireless Setup])

- To fire a test flash, press [DISP.].

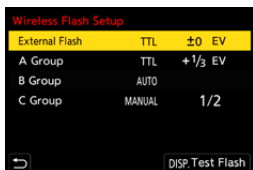

[External Flash]¹	[Firing Mode]	<p>[TTL]: The camera automatically sets the flash output.</p> <p>[AUTO]²: Sets the flash output on the external flash side.</p> <p>[MANUAL]: Sets the flash output of the external flash manually.</p> <p>[OFF]: The external flash outputs only communication light.</p>
	[Flash Adjust.]	Adjusts the flash output of the external flash manually when [Firing Mode] is set to [TTL].
	[Manual Flash Adjust.]	<p>Sets the flash output of the external flash when [Firing Mode] is set to [MANUAL].</p> <ul style="list-style-type: none"> It can be set within the range of [1/1] (full flash output) to [1/128] in 1/3 steps.

[A Group]/ [B Group]/ [C Group]	[Firing Mode]	<p>[TTL]: The camera automatically sets the flash output.</p> <p>[AUTO]^{*1}: Sets the flash output on the wireless flash side.</p> <p>[MANUAL]: Sets the flash output of the wireless flash manually.</p> <p>[OFF]: The wireless flashes of the specified group will not fire.</p>
	[Flash Adjust.]	<p>Adjusts the flash output of the wireless flash manually when [Firing Mode] is set to [TTL].</p>
	[Manual Flash Adjust.]	<p>Sets the flash output of the wireless flash when [Firing Mode] is set to [MANUAL].</p> <ul style="list-style-type: none"> • It can be set within the range of [1/1] (full flash output) to [1/128] in 1/3 steps.

*1 This cannot be selected when [Wireless FP] is set.

*2 This cannot be set when using the Flash (DMW-FL200L: optional).

❖ [Wireless FP]

The external flash performs FP firing (repeated high-speed firing of the flash) during wireless recording, enabling recording using the Flash even at fast shutter speeds.

 → [] → [] → Select [Wireless FP]

Settings: [ON]/[OFF]

❖ [Communication Light]

Set the strength of communication light.

 → [] → [] → Select [Communication Light]

Settings: [HIGH]/[STANDARD]/[LOW]

Video Settings

This chapter describes the Creative Video mode, a recording mode especially for video, and settings available when recording videos.

- [Recording Modes Specifically for Video \(Creative Video\): 394](#)
- [Using AF \(Video\): 402](#)
- [Video Brightness and Coloring: 407](#)
- [Audio Settings: 413](#)
- [External Microphones \(Optional\): 424](#)
- [XLR Microphone Adaptor \(Optional\): 429](#)
- [Headphones: 433](#)
- [Time Code: 437](#)
- [Synchronizing the Time Code with an External Device: 440](#)
- [Main Assist Functions: 448](#)

Recording Modes Specifically for Video (Creative Video)

- [Displays Suited to Video Recording: 395](#)
- [Setting the Exposure for Recording Videos: 396](#)
- [Separating Settings for Recording Video and Pictures: 400](#)



The [M] mode (Creative Video mode) is a recording mode specifically for video recording in which you can use all video functions.

In the [M] mode, the recording screen switch to displays suited to video recording.

You can start and stop video recording with the shutter button.

Change the exposure and audio settings with touch operation to prevent operation sounds from being recorded.

Settings such as exposure and white balance can be changed independent of picture taking settings.

Displays Suited to Video Recording

In the recording screen, the following parts switch to displays suited to video recording.

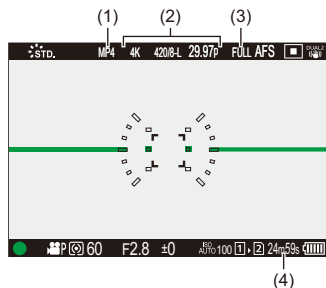

- (1) Recording file format (→ [\[Rec. File Format\]: 140](#))
- (2) Recording quality (→ [\[Rec Quality\]: 142](#))
- (3) Image area of video (→ [\[Image Area of Video\]: 166](#))
- (4) Video recording time (→ [Video Recording Time: 909](#))



- Examples of displays at the time of purchase.

For information about the icons other than those described here (→ [Monitor/Viewfinder Displays: 849](#))



- Even in the [iA]/[P]/[A]/[S]/[M] modes, as with the [iCM] mode, you can switch to the display suited to video recording:
(→ [\[Video-Priority Display\]: 661](#))

Setting the Exposure for Recording Videos

- 1 Set the recording mode to [M].**
 - Set the mode dial. (→ [Selecting the Recording Mode: 82](#))
- 2 Set the exposure mode.**
 -  → [] → [] → [Exposure Mode] → [P]/[A]/[S]/[M]
 - You can perform the same exposure operations as the [P]/[A]/[S]/[M] modes.
- 3 Close the menu.**
 - Press the shutter button halfway.
- 4 Start recording.**
 - Press the shutter button (A), video rec. button (B), or sub video rec. button (C).

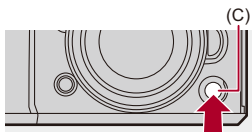
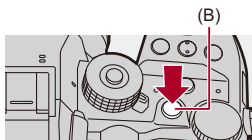
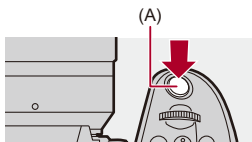

5 Stop recording.

- Press the shutter button, video rec. button, or sub video rec. button again.



- You can disable the recording start/stop operations using the shutter button:
(→ [\[Assign REC to Shutter Button\]: 638](#))
- You can assign the function that starts/ends video recording only in the [M] mode to an Fn button:
(→ [\[Video Record\(Creative Video\)\]: 606](#))

❖ Operations During Video Recording

Change the exposure and audio settings with touch operation to prevent operation sounds from being recorded.



- With the default settings, the Touch Tab is not displayed.
Set [Touch Tab] to [ON] in [Touch Settings] in the [Custom] ([Operation]) menu.
(→[Touch Settings]: 640)

- 1 Touch [.
- 2 Touch an icon.

 Zoom

F Aperture value

SS Shutter speed

 Exposure compensation

ISO/GAIN ISO sensitivity/Gain (dB)

 Sound recording level adjustment

(→[Sound Rec Level Adj.]: 417)

3 Drag the slide bar to set the item.

[▼]/[▲]: Changes the setting slowly.

[▾]/[▲]: Changes the setting quickly.

- If you touch icon (D), the screen of Step 2 is redisplayed.

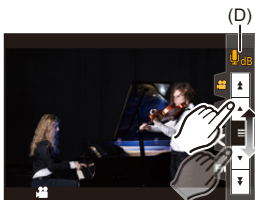

Separating Settings for Recording Video and Pictures



In default settings, settings such as exposure and white balance changed in [CAM] mode are also reflected in picture recording in [P]/[A]/[S]/[M] modes.

From the [CreativeVideo Combined Set.] menu, you can separate settings for video recording and for picture recording.

 →  →  → **Select [CreativeVideo Combined Set.]**

[F/SS/ISO/Exposure Comp.]/[White Balance]/[Photo Style]/[Metering Mode]/[AF Mode]

: The recording settings are linked across recording modes.



: Recording settings can be separated by the [CAM] mode and the [P]/[A]/[S]/[M] mode.

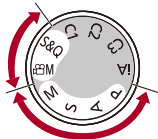



- The [iA] mode uses the optimum recording settings for the camera automatically, so the recording settings will be independent, irrespective of the settings made with this function.

Using AF (Video)

- [Continuous AF]: 402
- [AF Custom Setting(Video)]: 404
- [Enlarged Live Display(Video)]: 405

[Continuous AF]



You can select how to set the focus in AF when recording videos.



[MODE1]

The camera continues to automatically focus only during recording.

[MODE2]

The camera automatically keeps focusing on subjects during recording standby and during recording.

- This is available in [M] mode.

[OFF]

The camera maintains the focus point at the start of recording.



- In the [iA] mode, the camera automatically keeps focusing during recording standby, irrespective of the [Continuous AF] setting.
- Depending on the recording conditions or lens used, the AF operation sound may be recorded during video recording.
If the operation sound bothers you, we recommend recording with [Continuous AF] set to [OFF].
- If the zoom is operated while recording videos, the subject may take a while to come into focus.
- [MODE1] switches to [MODE2] when outputting via HDMI in the [∞M] mode.
- When set to [MODE2], the battery drains faster.

[AF Custom Setting(Video)]



You can fine-adjust the focusing method for video recording using [Continuous AF].



→ → → **Select [AF Custom Setting(Video)]**



[ON]	Enables the following settings.	
[OFF]	Disables the following settings.	
[SET]	[AF Speed]	<p>[+] side: Focus moves at a faster speed.</p> <p>[-] side: Focus moves at a slower speed.</p>
	[AF Sensitivity]	<p>[+] side: When the distance to the subject changes significantly, the camera immediately readjusts the focus.</p> <p>[-] side: When the distance to the subject changes significantly, the camera waits for a little before readjusting the focus.</p>

- A description of the item is displayed on the screen when you press [DISP].

[Enlarged Live Display(Video)]



When the AF mode is [, [, or [, or when recording with MF, the focus point can be enlarged for display.

(When the AF mode is [, or [, the center of the screen is enlarged for display.)

The focus point can also be enlarged for checking when recording videos.

- You can also perform the same operation by pressing the Fn button registered with [Enlarged Live Display(Video)]. (→ [Fn Buttons: 597](#))

Press the enlarged live display (video) button to enlarge display of the focus point.

- The operations on the enlarged display screen are the same as the MF Assist screen operations. (→ [Operations on the MF Assist Screen: 217](#))

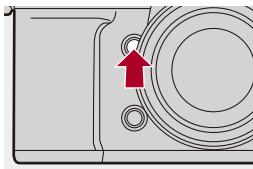



- If you use the following functions, enlarged display magnification is fixed at 3×:
 - [Crop Zoom(Video)]
- Depending on the lens used, the video enlarged display of live view screen may not be displayed.
- During video recording using the following functions, the video enlarged display of live view screen cannot be displayed:
 - [Rec Quality] with a high frame rate video exceeding a recording frame rate of 60.00p
 - [Variable Frame Rate]
 - [Live Cropping]
- When an interchangeable lens with no focus ring is attached, while you are using the following function, the video enlarged display of live view screen cannot be displayed:
 - [Variable Frame Rate]



- You can change the display method of the enlarged display screen:
(→ [\[Enlarged Live Display\(Video\)\]: 639](#))
- You can set whether to output the enlarged display to an external device connected via HDMI:
(→ [Outputting the Enlarged Live Display \(Video\) via HDMI: 530](#))

Video Brightness and Coloring

- [Luminance Level]: 407
- [Master Pedestal Level]: 409
- Recording While Controlling Overexposure (Knee): 410
- [ISO Sensitivity (video)]: 412

[Luminance Level]



You can set the luminance range to suit the purpose of video recording. You can set to [16-235] or [16-255], the standard for video, or to [0-255], which covers the entire range of luminance, the same as pictures.

 →  →  → **Select [Luminance Level]**

[0-255]([0-1023])

Setting for video recording at full range.

[16-235]([64-940])

Setting for video recording at video range.

[16-255]([64-1023])

Setting for video recording at video range.

- The display may not show the correct gradation depending on the monitor, the video playback software, and the video editing software that you are using.
-



- When set to a 10-bit [Rec Quality], the setting items change to [0-1023], [64-940], and [64-1023].
- When [Rec. File Format] is set to 422 HQ or 422 in [Apple ProRes], this is fixed to [16-235] ([64-940]).
- When [Rec. File Format] is set to [MP4] or [MOV] and [Photo Style] is set to [V-Log] or [REAL TIME LUT] (base Photo Style is [V-Log]), this is fixed to [0-255] ([0-1023]). However, even if [Photo Style] is set to [REAL TIME LUT] (base Photo Style is [V-Log]) or Photo Style is set to [V-Log] in My Photo Style, if a [Vlog_709] LUT file has been applied, this is fixed to [16-255] ([64-1023]).
- When the [Photo Style] is set to [ARRI LogC3], [Hybrid Log Gamma], or [REAL TIME LUT] (base Photo Style is [ARRI LogC3] or [Hybrid Log Gamma]), this is fixed to [64-940].

[Master Pedestal Level]



You can adjust the black level, which serves as the reference for images.

- 1 **Set the recording mode to [M].**
 - Set the mode dial. (→ [Selecting the Recording Mode: 82](#))
- 2 **Select [Master Pedestal Level].**
 - → → → [Master Pedestal Level]
- 3 **Adjust master pedestal.**
 - Rotate , or .
 - Set in the range between -15 and +15.



- [Master Pedestal Level] is not available when using the following function:
– [V-Log]/[ARRI LogC3]/[REAL TIME LUT] ([Photo Style])

Recording While Controlling Overexposure (Knee)



When [Photo Style] is set to [Like709], you can adjust the knee so that recording can be performed with minimal overexposure.

1 Set [Photo Style] to [Like709].

- → → → [Photo Style] → [Like709]

2 Press [Q].

3 Select a knee setting.

- Press to select a setting item.

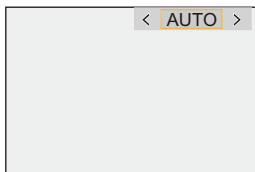

[AUTO]

Adjusts the compression levels of high-luminance areas automatically.



[MANUAL]

You can set the luminance where compression starts (knee master point) and the intensity of compression (knee master slope).

Press ▲ ▼ to select an item and then press ◀ ▶ to adjust.

[POINT]: Master knee point

[SLOPE]: Master knee slope

- Rotate  to adjust the knee master point, and  to adjust the knee master slope.
 - Values within the following ranges can be set:
 - Master knee point: 80.0 to 107.0
 - Master knee slope: 0 to 99
-

[Off]

4 Confirm your selection.

- Press  or .

[ISO Sensitivity (video)]



Sets the lower and upper limits for ISO sensitivity when ISO sensitivity is set to [AUTO].

- 1 **Set the recording mode to [M].**
 - Set the mode dial. (→ [Selecting the Recording Mode: 82](#))
- 2 **Set [ISO Sensitivity (video)].**
 - → [] → [] → [ISO Sensitivity (video)]

❖ Setting Items ([ISO Sensitivity (video)])

[ISO Auto Lower Limit Setting]

Sets the lower limit for ISO sensitivity when ISO sensitivity is [AUTO].

- Sensor output 60 fps or lower: Set in the range between [100] and [6400].
- Sensor output 61 fps or higher: Set in the range between [100] and [1600].

[ISO Auto Upper Limit Setting]

Sets the upper limit for ISO sensitivity when ISO sensitivity is [AUTO].

- Sensor output 60 fps or lower: Set to [AUTO] or in the range between [200] and [12800].
- Sensor output 61 fps or higher: Set to [AUTO] or in the range between [200] and [3200].



- The range of ISO sensitivities you can set depends on the Photo Style used.

Audio Settings

- [Sound Rec Level Disp.]: 414
- [Mute Sound Input]: 415
- [Sound Rec Gain Level]: 416
- [Sound Rec Level Adj.]: 417
- [Sound Rec Quality]: 418
- [Sound Rec Level Limiter]: 420
- [Wind Noise Canceller]: 421
- [Lens Noise Cut]: 422
- [Audio Information]: 423



[Sound Rec Level Disp.]

The sound recording level is displayed on the recording screen.

 →  →  → **Select [Sound Rec Level Disp.]**

[ON]	Sound recording level displayed on the recording screen.	
[OFF]	—	
[SET]	Sets the display size of sound recording level.	
	[Displaying Size]	[LARGE]/[SMALL]



- When [Sound Rec Level Limiter] is set to [OFF], [Sound Rec Level Disp.] is fixed to [ON].

[Mute Sound Input]

This mutes audio input.

 →  →  → **Select [Mute Sound Input]**

Settings: [ON]/[OFF]



-  is displayed on the recording screen.

[Sound Rec Gain Level]

This switches the gain of audio input.

 →  →  → **Select [Sound Rec Gain Level]**

[STANDARD]

This is the standard input gain setting. (0 dB)

[LOW]

Audio input is reduced for recording in environments with loud noises. (-12 dB)





- When [4ch Audio Recording] is set to other than [OFF], the sound recording gain of CH3/CH4 can be adjusted. (→[4ch Audio Recording]: 432)
- [Sound Rec Gain Level] is not available when [Mic Socket] is set to [LINE] and an external audio device is connected.

[Sound Rec Level Adj.]

Manually adjust the sound recording level.

 →  →  → **Select [Sound Rec Level Adj.]**

• Press ◀▶ to adjust the sound recording level and then press  or .

Settings: [MUTE]/[-18dB] to [+12dB]



- You can adjust by 1 dB increments.
- This can also be set during video recording.
- Displayed dB values are approximate.
- When set to [MUTE],  is displayed in the recording screen.
- When [4ch Audio Recording] is set to other than [OFF], the sound recording level of CH3/CH4 can be adjusted. (→[\[4ch Audio Recording\]: 432](#))

[Sound Rec Quality]

Sound quality for video can be set when the [Rec. File Format] is [MOV] or [Apple ProRes].

32-bit float recording is possible when an XLR Microphone Adaptor (DMW-XLR2: optional) is connected.

 →  →  → **Select [Sound Rec Quality]**

[96kHz/32bit]

Audio is recorded using 96 kHz/32 bit float format.

- This can be set when an XLR Microphone Adaptor is connected and [4ch Audio Recording] is set to [OFF].

[48kHz/32bit]

Audio is recorded using 48 kHz/32 bit float format.

- This can be set when an XLR Microphone Adaptor is connected and [4ch Audio Recording] is set to [XLR] or [OFF].

[96kHz/24bit]

Audio is recorded using 96kHz/24bit linear format.

- This can be set when an XLR Microphone Adaptor (DMW-XLR2: optional), Stereo Shotgun Microphone (DMW-MS2: optional), or Stereo Microphone (VW-VMS10: optional) is connected. (→ [XLR Microphone Adaptor \(Optional\): 429](#), [External Microphones \(Optional\): 424](#))

[48kHz/24bit]

Audio is recorded using 48kHz/24bit linear format.



- When [4ch Audio Recording] is [XLR], you cannot set to [96kHz/32bit] or [96kHz/24bit].
- When [4ch Audio Recording] is [XLR+CAMERA], you cannot set to [96kHz/32bit] or [48kHz/32bit].
- The setting is fixed to [48kHz/16bit] in the following case:
 - When [Rec. File Format] is set to [MP4]
- The recording volume may vary if you switch between float format and linear format.

[Sound Rec Level Limiter]

The sound recording level is adjusted automatically to minimize sound distortion (crackling noise).



Select [Sound Rec Level Limiter]

Settings: [ON]/[OFF]

[Wind Noise Canceller]

This reduces the wind noise coming into the built-in microphone while maintaining sound quality.



Select [Wind Noise Canceller]

[HIGH]

This effectively reduces the wind noise by reducing the low-pitched sound when a strong wind is detected.

[STANDARD]

This reduces wind noise without loss of sound quality by filtering out only wind noise.

[OFF]

Turns the function off.



- You may not see the full effect depending on the recording conditions.
- This function works only with the built-in microphone.

When an external microphone is connected, [Wind Cut] is displayed.

(→ [Reduction of Wind Noise: 428](#))

[Lens Noise Cut]

When using a lens compatible with power zoom, this reduces the sounds made by the zoom when it operates during video recording.

 →  →  → **Select [Lens Noise Cut]**

Settings: [ON]/[OFF]



- When this function is used, the sound quality may differ from that during normal operation.

[Audio Information]

This screen enables you to view audio settings and the status of recording all at once.

You can also touch the screen to change the settings.

- The operations on the audio information display screen are the same as the control panel operations. (→ [Control Panel: 99](#))

Press [**i**].

- You can also display it by touching the audio display area on the control panel (Creative Video mode).
- For information about the screen (→ [Audio Information Display: 864](#))

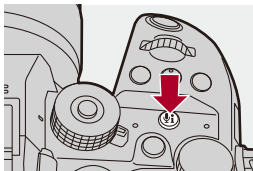

External Microphones (Optional)

- [Setting the Sound Pickup Range \(DMW-MS2: Optional\): 427](#)
- [Reduction of Wind Noise: 428](#)



With a Stereo Shotgun Microphone (DMW-MS2: optional) or Stereo Microphone (VW-VMS10: optional), you can record higher-quality high resolution audio compared to the built-in microphone.

- Some optional accessories may not be available in some countries.

1 Set the [Mic Socket] that suits the device to be connected.

- → → → [Mic Socket]



MIC Ψ ([Mic Input (Plug-in Power)])

When connecting an external microphone that requires a power supply from the camera [MIC] socket.

MIC ([Mic Input])

When connecting an external microphone that does not require a power supply from the camera [MIC] socket.

LINE ([Line Input])

When connecting an external audio device for line output.

- The setting will be fixed to [MIC Ψ] when a Stereo Shotgun Microphone (DMW-MS2: optional) is connected.
- When using [MIC Ψ], if you connect an external microphone that does not require power supply, the connected external microphone may malfunction. Check the device before connecting.

2 Set the camera on/off switch to [OFF].

3 Connect the external microphone to the camera and then turn on the camera.

- If mounting the external microphone on the camera hot shoe (A), remove the hot shoe cover. (→ [Removing the Hot Shoe Cover: 374](#))

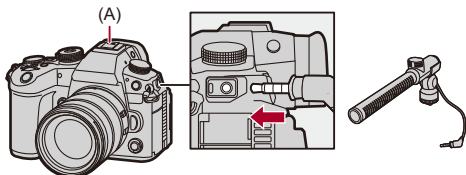

4 Make settings for the sound quality of the audio to be recorded in [Sound Rec Quality] (→ [\[Sound Rec Quality\]: 418](#)).



- Use a stereo microphone cable with the length less than 3 m (9.8 feet).
- While the external microphone is connected, [EXT.] is displayed on the screen.
- When an external microphone is connected, [Sound Rec Level Disp.] automatically turns [ON], and the recording level is displayed on the screen.
- When the external microphone is attached, do not carry the camera by holding the external microphone. It may become detached.
- If noises are recorded when using the AC adaptor, use the battery.
- For details, refer to the operating instructions for the external microphone.

Setting the Sound Pickup Range (DMW-MS2: Optional)

When using the Stereo Shotgun Microphone (DMW-MS2: optional), you can set the microphone sound pickup range.



Select [Special Mic.]

[STEREO]

Picks up sound over a wide area.

[SHOTGUN]

Helps prevent picking up background noise, and records sound from a specific direction.

Reduction of Wind Noise

This reduces wind noise when an external microphone is connected.

 ➔  ➔  ➔ **Select [Wind Cut]**

Settings: [HIGH]/[STANDARD]/[LOW]/[OFF]



- Setting [Wind Cut] may alter the usual sound quality.

XLR Microphone Adaptor (Optional)

- [\[4ch Audio Recording\]: 432](#)



By attaching an XLR Microphone Adaptor (DMW-XLR2: optional), you can use a commercially available XLR microphone, etc., to enable superior-quality 32-bit float recording and 4-channel audio recording. (→ [\[Sound Rec Quality\]: 418](#), [\[4ch Audio Recording\]: 432](#))

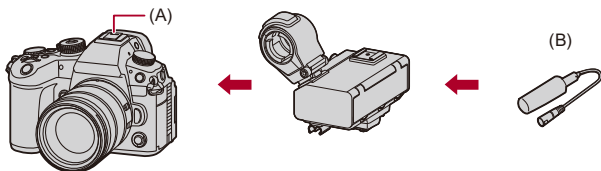

(A) Hot shoe

(B) Commercially available XLR microphone, etc.

Getting started:

- Turn off the camera, and remove the hot shoe cover. (→ [Removing the Hot Shoe Cover: 374](#))

1 Attach the XLR Microphone Adaptor to the hot shoe, and then turn on the camera.

•  ⇒ [] ⇒ [] ⇒ [XLR Mic Adaptor Setting]

- When the XLR Microphone Adaptor is attached, [XLR Mic Adaptor Setting] automatically turns [ON].
-

[ON]

Records the audio of a device connected to the XLR Microphone Adaptor.

[OFF]

Records audio using the built-in microphone of the camera.

2 Make settings for the sound quality of the audio to be recorded in [Sound Rec Quality] (⇒ [\[Sound Rec Quality\]: 418](#)).



Notes Regarding the Optional XLR Microphone Adaptor DMW-XLR1

You can also use DMW-XLR1 (optional), but there are the following limitations:

- The following functions cannot be used:
 - [XLR] of [4ch Audio Recording]
 - [96kHz/32bit] and [48kHz/32bit] ([Sound Rec Quality])We recommend using DMW-XLR2 (optional).



- While an XLR Microphone Adaptor is attached, [XLR] is displayed on the screen.
- When [XLR Mic Adaptor Setting] is set to [ON] and [4ch Audio Recording] is [OFF], the following settings are fixed:
 - [Sound Rec Level Limiter]: [OFF]
 - [Wind Noise Canceller]: [OFF]
 - [Sound Output]: [REC SOUND]
- When [XLR Mic Adaptor Setting] is set to [ON] and [4ch Audio Recording] is [OFF], [Sound Rec Gain Level] and [Sound Rec Level Adj.] are not available.
- When the XLR Microphone Adaptor is attached, [Sound Rec Level Disp.] automatically turns [ON], and the recording level is displayed on the screen.
- When the XLR Microphone Adaptor is attached, do not carry the camera by holding the XLR Microphone Adaptor. It may become detached.
- If noises are recorded when using the AC adaptor, use the battery.
- If you start video recording immediately after turning on the camera, a period with no sound may be recorded at the beginning.
- For details, refer to the operating instructions for the XLR Microphone Adaptor.

[4ch Audio Recording]

You can record 4-channel audio by using an XLR Microphone Adaptor (DMW-XLR2: optional) to which is connected a commercially available XLR microphone, etc.

By combining a Stereo Shotgun Microphone (DMW-MS2: optional) or a Stereo Microphone (VW-VMS10: optional) instead of using the built-in microphone, it is also possible to record 4-channel 96 kHz/24-bit high-resolution audio. (→ [External Microphones \(Optional\): 424](#))



Select [4ch Audio Recording]

[XLR]

Records the audio of a device connected to the XLR Microphone Adaptor to CH1/CH2/CH3/CH4.

[XLR+CAMERA]

Records the audio of a device connected to the XLR Microphone Adaptor to CH1/CH2. The audio from the built-in microphone of the camera or the external microphone connected to the camera is recorded to CH3/CH4.

[OFF]

Records the audio of a device connected to the XLR Microphone Adaptor to CH1/CH2.



- When [4ch Audio Recording] is set to other than [OFF], it is displayed as [4ch] on the screen.
- 4-channel audio is output to external devices connected via HDMI when [4ch Audio Recording] is set to other than [OFF].
- This cannot be set when [Rec. File Format] is [MP4].
- This cannot be set when [XLR Mic Adaptor Setting] is [OFF].

Headphones

- [\[Sound Monitoring Channel\]: 435](#)



You can record videos while monitoring their sound by connecting commercially available headphones to the camera.

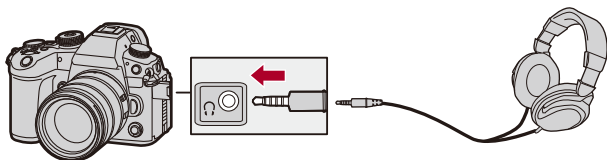

- Use a headphone cable with the length less than 3 m (9.8 feet).
- When headphones are connected, beep sounds, AF beep, and electronic shutter sounds are muted.

❖ Switching the Sound Output Method

 ⇒ [] ⇒ [] ⇒ Select [Sound Output]

[REALTIME]

Audio without time lag.

It may differ from the sound recorded in videos.

[REC SOUND]

Audio to be recorded in videos.

Output sound may be delayed from actual sound.



- The setting is fixed to [REC SOUND] in the following case:
 - When using an XLR Microphone Adaptor (DMW-XLR2: optional)
(When [4ch Audio Recording] is set to [OFF])

❖ Adjusting the Headphone Volume



Connect the headphones and rotate .





(): Reduces the volume.

(): Increases the volume.

To adjust the volume using the menu:

1 Select [Headphone Volume].

•  ⇒ [] ⇒ [] ⇒ [Headphone Volume]

2 Press   to adjust the headphone volume and then press  or .

• It can be adjusted in a range of [0] to [LEVEL15].

[Sound Monitoring Channel]

You can set the audio channel output to the headphones when recording. For information about the audio channel settings during playback (→[Sound Monitoring Channel(Play)]: 684)



Select [Sound Monitoring Channel]

[CH1/CH2]

Outputs CH1 (L)/CH2 (R).

[CH3/CH4]

Outputs CH3 (L)/CH4 (R).

[CH1+CH2/CH3+CH4]

Outputs CH1+CH2 (L)/CH3+CH4 (R).

[CH1]

Outputs CH1.

[CH2]

Outputs CH2.

[CH3]

Outputs CH3.

[CH4]

Outputs CH4.

[CH1+CH2]

Outputs a mix of CH1 and CH2.

[CH3+CH4]

Outputs a mix of CH3 and CH4.

[CH1+CH2+CH3+CH4]

Outputs a mix of CH1, CH2, CH3, and CH4.



- This can also be set during video recording.

Time Code

- [Setting the Time Code: 438](#)





When [Rec. File Format] is set to [MOV] or [Apple ProRes], the time code is automatically recorded during video recording. If [MP4], the time code is not recorded.

Setting the Time Code

Sets the recording, display, and output of the time code.

1 Set [Rec. File Format] to [MOV] or [Apple ProRes].

-  → [] → [] → [Rec. File Format] → [MOV]/[Apple ProRes]

2 Select [Time Code].

-  → [] → [] → [Time Code]

[Time Code Display]

Displays the time code on the recording screen/playback screen.

[Count Up]

[REC RUN]: Counts the time code only when recording videos.

[FREE RUN]: Counts the time code also when video recording is stopped and when the camera is turned off.

- When the following function is being used, [Count Up] is fixed to [REC RUN]:
– [Variable Frame Rate]

[Time Code Value]

[Reset]: Sets to 00:00:00:00 (hour: minute: second: frame)

[Manual Input]: Manually input hour, minute, second and frame.

[Current Time]: Sets hour, minute and second to current time and sets frame to 00.

[Time Code Mode]

[DF]: Drop Frame. The camera modifies the difference between recorded time and time code.

- Seconds and frames are separated by “.”. (Example: 00:00:00.00)

[NDF]: Non-Drop Frame. Records the time code without drop frame.

- Seconds and frames are separated by “:”. (Example: 00:00:00:00)
 - When the following functions are being used, [Time Code Mode] is fixed to [NDF]:
 - [50.00Hz (PAL)]/[24.00Hz (CINEMA)] ([System Frequency])
 - 47.95p or 23.98p [Rec Quality]
-

[HDMI Time Code Output]

Time code information is added to images output via HDMI when recording with the [pM] mode.

- The time code can also be output via HDMI by setting the mode dial to [pM] during playback. In the [Setup] ([IN/OUT]) menu, set [Output Resolution(Playback)] in [HDMI Connection] to [AUTO]. (→[Output Resolution(Playback)]: 688)
 - The device screen may go dark depending on the connected device.
-

[External TC Setting]

Synchronize the time code default value with an external device that supports time code input and output. (→[Synchronizing the Time Code with an External Device]: 440)

[TC Synchronization]: Selects the input and output for time code signals.

[TC Output Reference]: Sets the timing for time code signal output.

Synchronizing the Time Code with an External Device

- Preparations for Time Code Synchronization: 441
- Synchronize the Time Code of the External Device with That of the Camera (TC OUT): 443
- Synchronize the Time Code of the Camera with That of the External Device (TC IN): 445



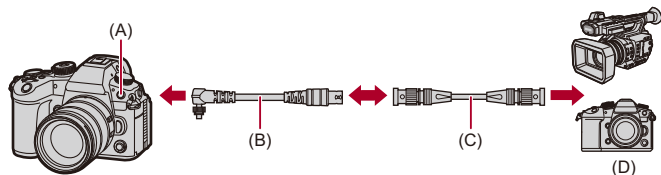

Synchronize the time code default value with an external device that supports time code signal input and output.



- (A) Flash synchro socket
- (B) BNC conversion cable (for TC IN/OUT) (supplied)
- (C) BNC cable (commercially available)
- (D) External devices

Preparations for Time Code Synchronization

When [Count Up] is set to [FREE RUN] in the [⏸M] mode, you can synchronize the initial value of the time code with an external device.

- 1 Set the recording mode to [⏸M].**
 - Set the mode dial. (→ [Selecting the Recording Mode: 82](#))
- 2 Set [Count Up] to [FREE RUN].**
 -  →  →  → [Time Code] → [Count Up] → [FREE RUN]
- 3 Rotate the flash synchro socket cap in the direction of the arrow to remove.**
 - Be careful not to lose the flash synchro socket cap.

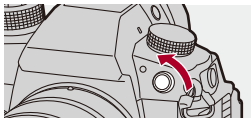

- 4 Insert the BNC conversion cable (for TC IN/OUT), and then rotate the locking screw in the direction of the arrow to attach the cable.**

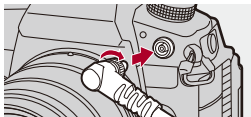

5 Connect the BNC conversion cable (for TC IN/OUT) and the external device with the BNC cable.





- Always use a supplied BNC conversion cable (for TC IN/OUT).
- Use a BNC cable with the length less than 2.8 m (9.2 feet).
- We recommend using a 5C-FB equivalent double-shielded BNC cables.

Synchronize the Time Code of the External Device with That of the Camera (TC OUT)

The initial time code value of the external device is synchronized according to the time code signal (LTC signal) of the camera.

1 Prepare for time code synchronizing. (→ [Preparations for Time Code Synchronization: 441](#))

2 Select [TC Output Reference].

-  →  →  → [Time Code] → [External TC Setting] → [TC Output Reference]



[REC]

Outputs the time code signal for the images that you record.

[HDMI]

When connected with an external device (external recorder, etc.) via HDMI, the time code signal output is delayed slightly to match the HDMI images.

3 Set [TC Synchronization] to [TC OUT].

-  →  →  → [Time Code] → [External TC Setting] → [TC Synchronization] → [TC OUT]
- The time code signal is output according to the recording frame rate of the [Rec Quality] and the [Time Code Mode] ([DF]/[NDF]) setting.

4 Operate the external device to synchronize the time code.

❖ **Outputting the Time Code Signal Again**

By setting as follows, the time code signal (LTC signal) can be output just by connecting with the external device with the BNC cable:



- [M] mode
- [Count Up] ([Time Code]): [FREE RUN]
- [TC Synchronization] ([External TC Setting] in [Time Code]): [TC OUT]

Synchronize the Time Code of the Camera with That of the External Device (TC IN)

The initial time code value of the camera is synchronized according to the time code signal (LTC signal) of the external device.



- In advance, change the [System Frequency] (→[System Frequency]: 138), [Rec Quality] (→[Rec Quality]: 142), and [Time Code Mode] (→[Time Code Mode]: 439) to match the external device.

- 1 Prepare for time code synchronizing. (→Preparations for Time Code Synchronization: 441)**
- 2 Set [TC Synchronization] to [TC IN].**
 -  →  →  → [Time Code] → [External TC Setting] → [TC Synchronization] → [TC IN]
- 3 Operate the external device to output the time code signal.**
 - Set the time code count method of the external device to free run, and output the signal.
 - When synchronized with the time code of an external device, this camera is in a slave state, and the [TC] of the time code shown on the screen switches to [**TC**].



- When multiple units of this camera are synchronized, the time code and exposure timings are synchronized so you can match the timings for starting exposure between cameras.

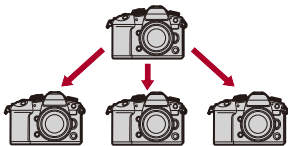

- The exposure timing can only be synchronized the first time after [TC Synchronization] is set to [TC IN].

❖ Maintaining, Releasing, and Restoring the Slave State

Even if you disconnect the BNC cable, the camera will remain in slave state.

- Perform one of the following operations to release the camera from the slave state.
 - Operate the camera on/off switch
 - Switch the recording mode
 - Change the [System Frequency]
 - Set the [Variable Frame Rate]
 - Switch the [Rec Quality] between 239.76p/119.88p/59.94p/59.94i/29.97p and a different recording frame rate
 - Change the following [Time Code] setting items:
 - [Count Up], [Time Code Value], [Time Code Mode], [TC Synchronization]
- To restore the slave state, reconnect the BNC cable to the external device while set as follows.

The time code signal (LTC signal) can be input just by connecting.

- [pM] mode
- [Count Up] ([Time Code]): [FREE RUN]
- [TC Synchronization] ([External TC Setting] in [Time Code]): [TC IN]



- Even when the system frequency differs between the camera and the external device, their initial time code values may be synchronized. Bear in mind, however, that the time codes lose sync as they count up.

Main Assist Functions

- [Flicker Decrease (Video)]: 449
- [SS/Gain Operation]: 450
- [WFM/Vector Scope]: 452
- [Luminance Spot Meter]: 456
- [Zebra Pattern]: 458
- [Frame Marker]: 460
- Color Bars/Test Tone: 462



- The [Custom] ([Monitor / Display (Video)]) menu has display assist functions such as the center marker and safety zone marker:

(→[Custom] menu ([Monitor / Display (Video)]): 658)

[Flicker Decrease (Video)]



The shutter speed can be fixed to reduce the flicker or striping in the video.

 →  →  → **Select [Flicker Decrease (Video)]**

[1/50]/[1/60]/[1/100]/[1/120]

[OFF]



- This can be set when [Auto Exposure in P/A/S/M] is [ON]. (→ [\[Auto Exposure in P/A/S/M\]: 632](#))

[SS/Gain Operation]



You can switch the units of shutter speed values and gain (sensitivity) values.

→ [] → [] → **Select [SS/Gain Operation]**

[SEC/ISO]

Displays the shutter speed in seconds and the gain in ISO.

[ANGLE/ISO]

Displays the shutter speed in degrees and the gain in ISO.

- The angle can be set in a range between 11° and 357°.
(when [Synchro Scan(Video)] is set to [OFF])
- When recording with [Variable Frame Rate], the angle can be set in the following ranges, according to the frame rate setting:
 - 1 fps: 11° to 45°
 - 2 fps: 11° to 90°
 - 12 fps or more: 11° to 355°

[SEC/dB]

Displays the shutter speed in seconds and the gain in dB.



- The setting items for gain are as follows:
 - Normal: [AUTO], [0dB] to [42dB]
 - When [Extended Gain Setting] is set: [-6dB] to [42dB]
 - 0 dB corresponds to either of the following ISO sensitivity values.
 - Normal: 100
 - When [V-Log]/[REAL TIME LUT] (base Photo Style is [V-Log]) is set in [Photo Style]: 500 (sensor output 60 fps or lower)/250 (sensor output 61 fps or higher)
 - When [ARRI LogC3]/[REAL TIME LUT] (base Photo Style is [ARRI LogC3]) is set in [Photo Style]: 320 (sensor output 60 fps or lower)/160 (sensor output 61 fps or higher)
 - When [Hybrid Log Gamma] is set in [Photo Style]: 250
-



- The range of gains you can set depends on the Photo Style used.
- When [SS/Gain Operation] is set to [SEC/dB], menu names change as shown below:
 - [ISO Sensitivity (video)] ➔ [Gain Setting]
 - [ISO Auto Lower Limit Setting] ➔ [Auto Gain Lower Limit Setting]
 - [ISO Auto Upper Limit Setting] ➔ [Auto Gain Upper Limit Setting]
 - [Extended ISO] ➔ [Extended Gain Setting]
 - [ISO Displayed Setting] ➔ [Gain Displayed Setting]

[WFM/Vector Scope]

This displays the waveform monitor or the vector scope on the recording screen. You can change the size of the waveform display.

- 1 Set the recording mode to [M].**
 - Set the mode dial. (→ [Selecting the Recording Mode: 82](#))
- 2 Set [WFM/Vector Scope].**
 -  → [] → [] → [WFM/Vector Scope]

[WAVE]



Displays a waveform.

[VECTOR]

Displays the vector scope.

[OFF]

3 Select the position to display.

- Press ▲▼◀▶ to select and then press  or .
- Positions can be moved to the diagonal directions using the joystick.
- You can also move using touch operations.
- You can rotate  to change the size of the waveform.
- To return the waveform or vector scope position back to the center, press [DISP.]. With waveform, pressing [DISP.] once again returns the size to the default setting.

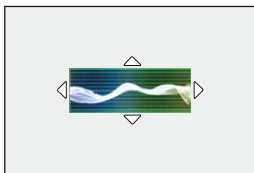

❖ Screen Displays

Waveform

- The waveform displayed on the camera indicates the luminance as values based on the conversions below:

0 % (IRE^{*}): Luminance value 16 (8 bit)/64 (10 bit)

100 % (IRE^{*}): Luminance value 235 (8 bit)/940 (10 bit)

* IRE: Institute of Radio Engineers



(A) 109 % (IRE) (Dotted line)

(B) 100 % (IRE)

(C) 50 % (IRE)

(D) 0 % (IRE)

(E) -4 % (IRE) (Dotted line)

(F) The range between 0 % and 100 % shows dotted lines at intervals of 10 %.

Display example)

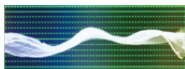

Vector scope



(G) R (Red)

(H) YL (Yellow)

(I) G (Green)

(J) MG (Magenta)

(K) B (Blue)

(L) CY (Cyan)

Display example)





- When you assign the function to an Fn button, you can switch between displaying and hiding these during recording of video. (→ [Fn Buttons: 597](#))
- You can also change the position by dragging on the recording screen.
- The waveform and vector scope are not output through HDMI.

[Luminance Spot Meter]



Specify any spot on the subject to measure the luminance over a small area.

1 Set [Luminance Spot Meter].

- Press **MENU/SET** → [] → [] → [Luminance Spot Meter] → [ON]

2 Select the position where you want to measure the luminance.

- Press **▲▼◀▶** to select and then press **MENU/SET** or  .
- Positions can be moved to the diagonal directions using the joystick.
- You can also change the position by dragging the frame on the recording screen.
- To return the position back to the center, press [DISP.].

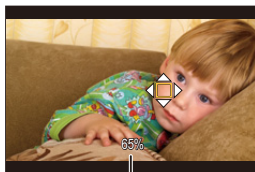

(M)

(M) Luminance value

❖ Measurement Range

Measuring is possible in the range -7 % to 109 % (IRE).

- When [Photo Style] is set to [V-Log]/[ARRI LogC3], or when a LUT file has not been applied in [REAL TIME LUT] (base Photo Style is [V-Log]/[ARRI LogC3]), this is measured with “Stop” units. (18 % gray output level is calculated as 0 Stop)

[Zebra Pattern]

Parts that are brighter than the base value are displayed with stripes. You can also set the base value and the breadth of the range so that the stripes are displayed on parts that are within the range of brightness you specify.

**[ZEBRA1]****[ZEBRA2]****[ZEBRA1+2]**

→ [] → [] → **Select [Zebra Pattern]**

[ZEBRA1]	Parts that are brighter than the base value are displayed with [ZEBRA1] stripes.	
[ZEBRA2]	Parts that are brighter than the base value are displayed with [ZEBRA2] stripes.	
[ZEBRA1+2]	Both [ZEBRA1] and [ZEBRA2] are displayed.	
[OFF]	—	
[SET]	Sets the base brightness.	
	[Zebra 1]	[50%] to [105%]/[BASE/RANGE]
	[Zebra 2]	[50%] to [105%]/[BASE/RANGE]

❖ When [BASE/RANGE] Was Selected with [SET]

Centered on the brightness set with [Base Level], parts with the brightness in the range set in [Range] are displayed with the stripes.

- [Base Level] can be set in the range between 0 % and 109 % (IRE).
- [Range] can be set in the range between ± 1 % and ± 10 % (IRE).
- When [Photo Style] is set to [V-Log]/[ARRI LogC3], or when a LUT file has not been applied in [REAL TIME LUT] (base Photo Style is [V-Log]/[ARRI LogC3]), this is measured with “Stop” units. (18 % gray output level is calculated as 0 Stop)



- [ZEBRA1+2] cannot be selected while you are setting [BASE/RANGE].

[Frame Marker]



A frame with the set aspect ratio is displayed on the recording screen. This allows you to see during recording the angle of view that will be achieved with trimming (cropping) in post-processing.

MENU/SET → **[⚙️]** → **[📷]** → **Select [Frame Marker]**

[ON]	Displays the Video Frame Marker on the recording screen.	
[OFF]	—	
[SET]	[Frame Aspect]	Sets the aspect ratio of the Video Frame Marker. [2.39:1]/[2.35:1]/[2.00:1]/[1.85:1]/[16:9]/[4:3]/[5:4]/[1:1]/[4:5]/[9:16]/[CUSTOM]
	[Frame Color]	Sets the color of the Video Frame Marker.
	[Frame Mask]	Sets the opacity of the outside of the Video Frame Marker. [100%]/[75%]/[50%]/[25%]/[OFF]

❖ When [CUSTOM] Is Selected with [Frame Aspect] in [SET]

You can freely set the aspect ratio of the frame.

- Press ▲▼◀▶ to move the center position.
 - Positions can be moved to the diagonal directions using the joystick.
 - You can also change the position by dragging the frame on the recording screen.
- Set the height of the frame with [], and the width with [].
 - You can also pinch out/pinch in the frame to change the size.

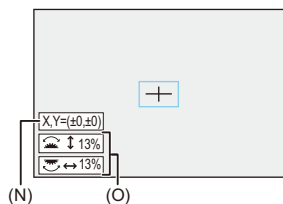

(N) Center coordinates (0 being the center of the screen)

(O) Height and width of the frame

- The aspect ratio can be set in the range between 1 % to 100 %.
- The first press of [DISP.] returns the frame position to the center.
The second press returns the frame size to the default.

Color Bars/Test Tone



The color bars are displayed on the recording screen.

A test tone is output while the color bars are being displayed.

 →  →  → **Select [Color Bars]**

Settings: [SMPTE]/[EBU]/[ARIB]

- To end the display, press .



[SMPTE]





[EBU]



[ARIB]

❖ Adjusting the Test Tone

There are 4 levels ([-12dB], [-18dB], [-20dB], and [MUTE]) of test tone to select.

Rotate ,  or  to select the test tone level.



- The color bars and test tone will be recorded on the video if video recording is started while the color bars are being displayed.
- The brightness and coloring that appear on the camera's monitor or viewfinder may differ from those that appear on another device such as an external monitor.

Special Video Recording

This chapter describes advanced video recording applications such as slow motion/quick motion video and Log recording.

- Variable Frame Rate: 465
- High Frame Rate Video: 470
- [Focus Transition]: 473
- [Live Cropping]: 478
- Log Recording: 483
- HLG Videos: 492
- Anamorphic Recording: 496
- [Synchro Scan(Video)]: 500
- [Loop Recording (video)]: 502
- [Segmented File Recording]: 505
- List of Recording Qualities That Enable Special Videos to be Recorded: 506

Variable Frame Rate



You can record smooth slow motion video and quick motion video by using a frame rate for recording that differs from the recording frame rate.

Slow Motion Video (Overcrank Recording)

Set a number of frames that is higher than the recording frame rate of the [Rec Quality].

For example: When recording at 48 fps when set to a 24.00p [Rec Quality], the speed is halved.

Quick Motion Video (Undercrank Recording)

Set a number of frames that is lower than the recording frame rate of the [Rec Quality].

For example: When recording at 12 fps when set to a 24.00p [Rec Quality], the speed is doubled.









- Variable frame rate video with a recording quality with the ALL-Intra image compression system cannot be recorded to SD cards. Use CFexpress cards.
- The volume of data recorded increases when you record slow motion video, so if the card writing speed is insufficient, recording may stop.

- 1 **Set the recording mode to [M].**
 - Set the mode dial. (→ [Selecting the Recording Mode: 82](#))
- 2 **Set [Rec. File Format] to [MOV].**
 -  → [] → [] → [Rec. File Format] → [MOV]
- 3 **Select a recording quality with which you can use [Variable Frame Rate] recording.**

-  → [] → [] → [Rec Quality]
- Items with which you can use [Variable Frame Rate] are indicated as [VFR available].
- Recording qualities with which you can use [Variable Frame Rate] recording (→ [List of Recording Qualities That Enable Special Videos to be Recorded: 506](#))



- 4 **Set [Variable Frame Rate].**
 -  → [] → [] → [Variable Frame Rate] → [ON]
 - Press ◀▶ to switch between [ON] and [OFF].
- 5 **Set the frame rate.**

- Rotate ,  or  to select a numeric value, then press  or .

❖ Available Frame Rate Setting Ranges

The frame rate you can set differs depending on the [Rec Quality] settings.

[Rec Quality]	Frame rate
C4K/4K video that uses the Long GOP image compression system	1 fps to 120 fps
5.7K video/C4K/4K video that use the ALL-Intra image compression system	1 fps to 60 fps
FHD video that uses the Long GOP image compression system	1 fps to 300 fps
FHD video that uses the ALL-Intra image compression system	1 fps to 240 fps

❖ Shutter Speeds When Recording Variable Frame Rate Video

When recording variable frame rate video, the minimum shutter speed changes depending on the set frame rate.

Frame rate	Minimum shutter speed
1 fps to 2 fps	1/8 of a second
12 fps	1/13 of a second
15 fps	1/15 of a second
20 fps	1/20 of a second
21 fps to 25 fps	1/25 of a second
26 fps to 30 fps	1/30 of a second
32 fps to 37 fps	1/40 of a second
45 fps to 50 fps	1/50 of a second
52 fps to 60 fps	1/60 of a second
62 fps to 75 fps	1/80 of a second
84 fps to 100 fps	1/100 of a second
105 fps to 125 fps	1/125 of a second
132 fps to 156 fps	1/160 of a second
165 fps to 200 fps	1/200 of a second
204 fps to 240 fps	1/250 of a second
250 fps to 300 fps	1/320 of a second



- You can filter to show just the recording qualities where [Variable Frame Rate] can be used. (→[Filtering]: 156)
- We recommend using a tripod when recording images with [Variable Frame Rate].



- Focus mode switches to MF.
(When using an interchangeable lens with no focus ring, you cannot set focus with MF.)
- The camera automatically focuses when [AF ON] is pressed, but only before starting recording.
- Audio will not be recorded during variable frame rate recording.
- When set to a frame rate exceeding 60 fps, there may be some deterioration in recording quality.
- When [Image Area of Video] is set to [PIXEL/PIXEL], a frame rate exceeding 120 fps cannot be set.
- When the following function is being used, [Variable Frame Rate] is not available:
 - [Filter Settings]

High Frame Rate Video



[MOV] video with high frame rates can be recorded to cards. By converting it with the compatible software, it is possible to produce slow motion video. AF recording and audio recording, not possible with [Variable Frame Rate], also become possible.

1 Set [Rec. File Format] to [MOV].

- → → → [Rec. File Format] → [MOV]

2 Select a recording quality for high frame rate video.

- → → → [Rec Quality]
- The following recording qualities are available in [] mode:
 - [Rec Quality] with a high frame rate video exceeding a recording frame rate of 60.00p
 - By filtering the [Rec Quality] by the frame rate, you can display just those recording qualities that match the frame rate conditions. (→ [\[Filtering\]: 156](#))
 - Recording Qualities for High Frame Rate Video (→ [List of Recording Qualities That Enable Special Videos to be Recorded: 506](#))

❖ Shutter Speeds When Recording High Frame Rate Video

When recording high frame rate video, the minimum shutter speed changes depending on the recording frame rate of the video.

Recording frame rate of the video	Minimum shutter speed	
	[AFS]/[AFC]	[MF]
47.95p	1/30 of a second	1/8 of a second*
48.00p	1/25 of a second	
100.00p	1/100 of a second	
119.88p/120.00p	1/125 of a second	
200.00p	1/200 of a second	
239.76p	1/250 of a second	

* Can be set in [M] mode ([Auto Exposure in P/A/S/M] is set to [OFF]) or [pM] mode ([Exposure Mode] is set to [M])



- When outputting via HDMI, the resolution and frame rate may be down-converted for output. (→ [Settings for Down-Converting: 522](#))



Notice regarding AF when recording high frame rate video

- When set to a [Rec Quality] where the recording frame rate is 200.00p or more, there is a limitation on the lenses on which AF is possible.

You can confirm which lenses are supported by this camera in “Compatible products which comply with Four-Thirds standard”. Refer to the “AF and AE in Motion picture recording” item.

<https://panasonic.jp/support/global/cs/dsc/connect/index.html>

(English only)

- When set to a [Rec Quality] where the recording frame rate is 200.00p or more, AF operation will be as follows:
 - AF mode is fixed to []. By pressing the shutter button halfway or pressing [AF ON], focusing is in the AF area of [].
 - Automatic detection is not available.
 - [Continuous AF] is not available.
 - [Quick AF] is not available.
 - [Eye Sensor AF] is not available.

[Focus Transition]







Smoothly transitions the focus position from the current position to a position registered in advance.

1 Set the recording mode to [M].

- Set the mode dial. (→ [Selecting the Recording Mode: 82](#))

2 Select [Focus Transition].

-  → [] → [] → [Focus Transition]
- If the [Please set the focus position.] message is displayed, press either  or .



3 Set focus positions.

- Check the focus using the same procedure as MF (→ [Record Using MF: 215](#)), and then press [WB], [ISO], and [] to set focus positions.
- You can also touch [POS1] to [POS3] to set focus positions.

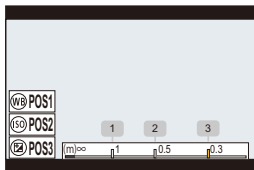



4 Register the focus positions.

- Press  or  to register the focus positions.

5 Start recording.

- Press the video rec. button.
- The advanced setting screen is displayed when you press [DISP.] before recording. (→ [Setting Items \(\[Focus Transition\]\): 476](#))
- If you have enabled [Focus Transition Rec], Focus Transition will start when you start recording a video.

6 Start Focus Transition.

- Press ◀▶ to select [1], [2], or [3], and then press  or .
- When [Focus Transition Wait] is set, Focus Transition starts after the set time has elapsed.

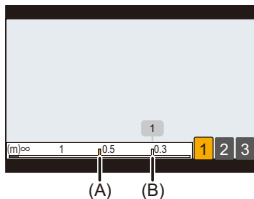

- (A) Current focus position
- (B) Registered focus position

7 End Focus Transition.

- Press [Q].

8 Stop recording.

- Press the video rec. button once again.

❖ **Setting Items ([Focus Transition])**

[Focus Position Setting]

Registers focus positions.

[Focus Transition Speed]

Sets the moving speed of focus.

- Moving speed: [SH] (fast) to [SL] (slow)
-

[Focus Transition Rec]

Starts Focus Transition when recording starts.

- Select the position registered with [Focus Position Setting].
-

[Focus Transition Wait]

Sets the wait time before the start of Focus Transition.

- The recording screen is displayed when you press [↵].



- Maintain the same distance to the subject after setting focus positions.
- The moving speed of focus varies depending on the lens being used.
- The moving speed of focus slows as it approaches the closest focusing distance of the lens or infinity.
- While using [Focus Transition], it is not possible to focus on anything other than one of the registered focus positions.
- Any of the operations below will clear the focus position settings.
 - Operating the camera on/off switch
 - Zoom operation
 - Switching the focus mode
 - Switching the recording mode
 - Replacing the lens
- When the following function is being used, [Focus Transition] is not available:
 - [Live Cropping]
- [Focus Transition] cannot be used when using an interchangeable lens that does not support the focus mode [AFC].

[Live Cropping]



By cropping a part of the image from the image displayed in the live view, it is possible to record 4K/FHD video that incorporates panning and zooming with the camera staying in a fixed position.

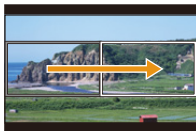

Pan

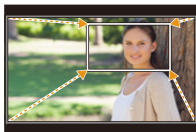

Zoom in





- Use a tripod to minimize camera shake.

1 Set the mode dial to [iM].

- Set the mode dial. (→ [Selecting the Recording Mode: 82](#))

2 Select a recording quality with which you can record [Live Cropping] video.

-  → [] → [] → [Rec Quality]
- A recording quality with which you can record [Live Cropping] video (→ [List of Recording Qualities That Enable Special Videos to be Recorded: 506](#))

3 Set the pan and zoom effect.

-  → [] → [] → [Live Cropping] → [SET]

[Cropping Duration]

You can set between 2 and 40 seconds.

[Easing Settings]

Select an effect.

[LINEAR]: Moves at a constant speed.

[EASE IN]: Gradually accelerates.

[EASE OUT]: Gradually decelerates.

[EASE IN OUT]: Decelerates after accelerating.

4 Set the cropping frame.

- **MENU/SET** → [] → [] → [Live Cropping] → [SET] → [Cropping Start/End Frame]
- Select the range to start cropping and press **MENU/SET** or .

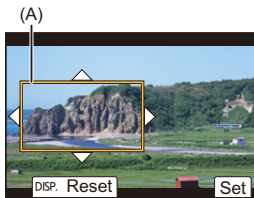

(A) Cropping start frame

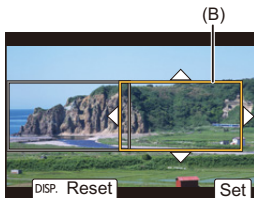

- Select the range to end cropping and press **MENU/SET** or .



(B) Cropping end frame

- To redo the settings for the position and size of the start frame and the end frame, press **◀**.
- Press [] to check the effect you have set.

5 Enable Live Cropping recording.

-  → [] → [] → [Live Cropping] → [ON]
- If you have selected a recording quality where Live Cropping recording is not available, the camera switches to a recording quality where recording is possible.

6 Start Live Cropping recording.

- Press the video rec. button.
- When the set operating time has elapsed, recording automatically ends. To end recording midway, press the video rec. button again.

(C)

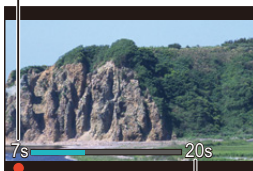





(D)

(C) Elapsed recording time

(D) Set operating time

❖ Operations for Setting the Cropping Frame

Button operation	Touch operation	Description of operation
	Touch	Moves the frame.
	Pinch out/ pinch in	Enlarges/reduces the frame in small steps.
	—	Enlarges/reduces the frame.
[DISP.]	[Reset]	Start frame: Returns the frame position and size to the default settings. End frame: Cancels the settings for the position and size of the frame.
	[Set]	Confirms the frame position and size.



- The AF mode switches to [AF-ON].
- Brightness measurements and focusing are performed within the cropping frame.
To lock the focus point, set [Continuous AF] to [OFF], or set the focus mode to [MF].
- [Metering Mode] will be [Multi] (multi-metering).
- [Image Area of Video] is fixed to [FULL].

Log Recording

- [\[Log View Assist\]: 490](#)



Setting [Photo Style] to [V-Log]/[ARRI LogC3] enables Log recording. Images finished with rich gradation can be created through post-production processing.

- **[ARRI LogC3] can be used only when you have used the Upgrade Software Key (DMW-SFU3A: optional) and enabled the function with [Activate]. (→[\[Activate\]: 692](#))**
 - This is available in [M] mode.
 - Recording qualities that enable use of the [ARRI LogC3] (→[List of Recording Qualities That Enable Special Videos to be Recorded: 506](#))

→ [] → [] → **[Photo Style] → Select [V-Log] or [ARRI LogC3]**

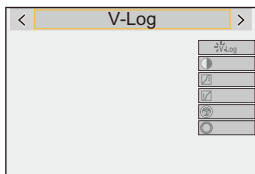



- Post-production processing is enabled by utilizing LUT (Look-Up Table). You can download the LUT file for [V-Log] from the following support site:
<https://panasonic.jp/support/global/cs/dsc/download/index3.html>
(English only)

Download the LUT file for [ARRI LogC3] from the following:

(1) ARRI Look Library (LogC3-to-Rec709)

A LUT file with the ARRI Look File applied for the Rec.709 color space. There are 87 types of Look Files, providing you with a great variety.

**[https://www.arri.com/resource/blob/365070/
de67ce8908d30b22d83526dc4c1c8732/
arri-look-library-logc3-to-rec709-3d-luts-data.zip](https://www.arri.com/resource/blob/365070/de67ce8908d30b22d83526dc4c1c8732/arri-look-library-logc3-to-rec709-3d-luts-data.zip)**

(2) ARRI Look Library (log-to-log)

A LUT file for applying Looks with the Log space as is with its rich color information.

Similarly to (1), there are 87 types of Look Files, providing you with a great variety.

**[https://www.arri.com/resource/blob/283984/
763aad4a2be5c301529704b1357513c/
arri-look-library-logc3-log-to-log-3d-luts-data.zip](https://www.arri.com/resource/blob/283984/763aad4a2be5c301529704b1357513c/arri-look-library-logc3-log-to-log-3d-luts-data.zip)**

(3) ARRI LogC3 LUT Package

A LUT file for converting from ARRI LogC3 to the color spaces of a variety of display devices.

By going through (2) ARRI Look Library (log-to-log), it is possible to produce the Look according to the color space you are aiming for.

**[https://www.arri.com/resource/blob/294620/
f4290b963ff83a4dde4fff795645bc26/
2022-09-arri-logc3-v1-2-lut-package-data.zip](https://www.arri.com/resource/blob/294620/f4290b963ff83a4dde4fff795645bc26/2022-09-arri-logc3-v1-2-lut-package-data.zip)**

Refer to the following site for information regarding **ARRI Look Files**:

**[https://www.arri.com/en/learn-help/learn-help-camera-system/
image-science/look-files](https://www.arri.com/en/learn-help/learn-help-camera-system/image-science/look-files)**

❖ ISO Sensitivity When [V-Log] Is Set

ISO sensitivity can be set in the range between [500] and [12800] (sensor output 60 fps or lower) or between [250] and [3200] (sensor output 61 fps or higher). You can set between [125] and [12800] when [Extended ISO] is set.

❖ ISO Sensitivity When [ARRI LogC3] Is Set

ISO sensitivity can be set in the range between [320] and [12800] (sensor output is 60 fps or less) or between [160] and [3200] (sensor output is 61 fps or more). When [Extended ISO] is set, it can be set in the range between [160] and [12800] (sensor output is 61 fps or more).

❖ Exposure When [V-Log] Is Set

The [V-Log] curve characteristics comply with “V-Log/V-Gamut REFERENCE MANUAL Rev.1.0”. When set to [V-Log], the standard exposure when gray with a reflectance ratio of 18 % is imaged is IRE 42 %.

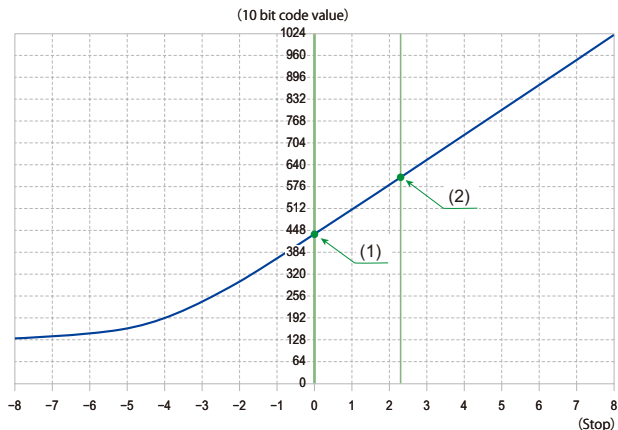

When [Photo Style] is set to [V-Log]				
Reflectance ratio (%)	IRE (%)	Stop	10 bit code value	12 bit code value
0	7.3	—	128	512
(1) 18	42	0.0	433	1732
(2) 90	61	2.3	602	2408

- When luminance is to be displayed by “Stop” units, this camera calculates IRE 42 % to “0 Stop”.

❖ Exposure When [ARRI LogC3] Is Set

The log characteristics of [ARRI LogC3] comply with 800 ASA (EI 800), described in “ARRI_ALEXA_LogC_Curve_in_VFX.pdf” released by ARRI. The log characteristics of [ARRI LogC3] on this camera do not depend on the ISO sensitivity settings. However, according to the Exposure Stops values defined in 800 ASA (EI 800), there will be the equivalent of 2 stops worth of clipping with sensor output of 60 fps or less and the equivalent of 3 stops worth of clipping with sensor output of 61 fps or more.

Refer to the following for “ARRI_ALEXA_LogC_Curve_in_VFX.pdf”:

<https://www.arri.com/resource/blob/31918/>

66f56e6abb6e5b6553929edf9aa7483e/

2017-03-alexa-logc-curve-in-vfx-data.pdf

Diagram of the log characteristics of [ARRI LogC3] on this camera

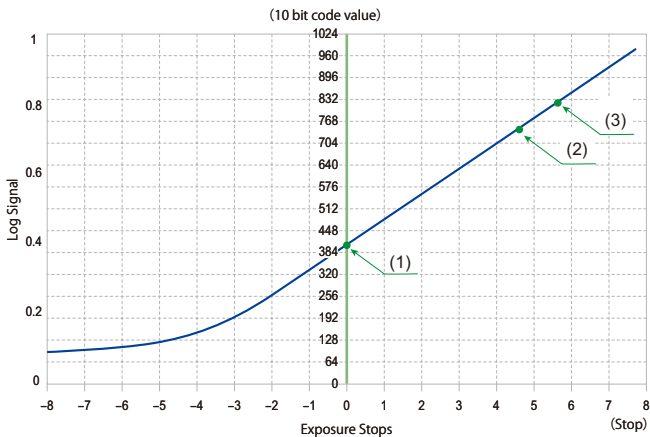

(1) 18 % gray

(2) Clipping level (sensor output 61 fps or higher)

(3) Clipping level (sensor output 60 fps or lower)

When [Photo Style] is set to [ARRI LogC3]							
	Exposure Stops (18 % gray standard)	Full range			Video range		
		IRE (%)	Code Value		IRE (%)	Code Value	
			10 bit	12 bit		10 bit	12 bit
Black level	—	3.5	95	380	9.2	145	580
(1)	0.0	38	400	1600	39	407	1628
(2)	4.6	78	748	2992	73	705	2820
(3)	5.6	87	824	3296	81	770	3080

- When the [Photo Style] is set to [ARRI LogC3] or [REAL TIME LUT] (base Photo Style is [ARRI LogC3]), the [Luminance Level] is fixed to [64-940] (video range).
- The recorded data is recorded as video range.
- HDMI output is output as video range.
- The waveform and vector scope are both displayed as video range.
- The luminance spot meter displays the 18 % gray output level as 0 Stop.



- Luminance can be checked by "Stop" units:
(→[Luminance Spot Meter]: 456, [Zebra Pattern]: 458)

[Log View Assist]

When [Photo Style] is set to [V-Log]/[ARRI LogC3], the recording screen and images output via HDMI will darken. Using [Log View Assist] means you can show images with LUT file applied on the monitor/viewfinder and output them via HDMI.

 →  →  → **Select [Log View Assist]**

[LUT Select(V-Log)]

Selects the LUT file to apply from a preset or LUT files registered in [LUT Library].

(→[LUT Library]: 364)

[LUT Select(ARRI LogC3)]

Selects the LUT file to apply from a preset or LUT files registered in [LUT Library].

(→[LUT Library]: 364)

- **The function can be used only when you have used the Upgrade Software Key (DMW-SFU3A: optional) and enabled the function with [Activate]. (→[Activate]: 692)**
-

[LUT View Assist (Monitor)]

Displays the images with LUT file applied on the monitor/viewfinder of the camera.

[LUT View Assist (HDMI)]

Applies LUT file to images output over HDMI.



- When applying the LUT file, [LUT] is displayed on the recording screen.
- When [Photo Style] is [V-Log], you cannot apply LUT files which are a base Photo Style other than [V-Log].
- When [Photo Style] is [ARRI LogC3], you cannot apply LUT files which are a base Photo Style other than [ARRI LogC3].
- [LUT View Assist (Monitor)]/[LUT View Assist (HDMI)] are not available when [LUT] is applied in the [Photo Style] image quality adjustments.

HLG Videos

- [\[HLG View Assist\]: 495](#)



Record videos with the wide dynamic range of the HLG format. You can record in very bright light where overexposure can occur or in dark areas where underexposure can occur, maintaining the rich yet subtle colors you can see with your naked eye.

You can view the video that you record by outputting via HDMI to devices (TVs, etc.) that support the HLG format, or playing back directly on supporting devices.

- “HLG (Hybrid Log Gamma)” is an international standard (ITU-R BT.2100) HDR format.

1 Set the recording mode to [M].

- Set the mode dial. (→ [Selecting the Recording Mode: 82](#))

2 Select a recording quality with which you can record HLG video.

-  → [] → [] → [Rec Quality]
- Items available for recording with HLG video are indicated as [HLG available].
- Recording qualities with which you can record HLG video (→ [List of Recording Qualities That Enable Special Videos to be Recorded: 506](#))



3 Set [Photo Style] to [Hybrid Log Gamma].

-  → [] → [] → [Photo Style] → [Hybrid Log Gamma]

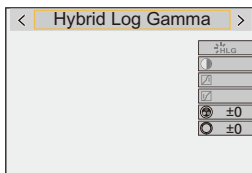



- The monitor and viewfinder on this camera do not support display of HLG format images.

With [Monitor] in [HLG View Assist] in the [Custom] ([Monitor / Display (Video)]) menu, you can display the images converted for monitoring on the monitor/viewfinder of this camera. (→[HLG View Assist]: 495)



- HLG images are shown dark on devices that do not support the HLG format. With [HDMI] in [HLG View Assist] in the [Custom] ([Monitor / Display (Video)]) menu, you can set the conversion method for images displayed for monitoring. (→[HLG View Assist]: 495)

❖ ISO Sensitivity When [Hybrid Log Gamma] Is Set

The lower limit of available ISO sensitivities will become [250].

[HLG View Assist]

At recording or playback of HLG video, this displays images with converted color gamut and brightness on the camera monitor/viewfinder, or outputs these over HDMI.

 ➔  ➔  ➔ **[HLG View Assist]** ➔ **[Monitor]** or **[HDMI]**

[AUTO]*

Converts images before outputting them via HDMI while applying the effect of [MODE2]. This conversion setting works only when the camera is connected to a device that does not support HDR (HLG format).

[MODE1]

Converts with an emphasis on bright areas such as sky.

- [MODE1] is displayed on the recording screen.

[MODE2]

Converts with an emphasis on the brightness of a main subject.

- [MODE2] is displayed on the recording screen.

[OFF]

Displays without converting color gamut and brightness.

- HLG images appear darker on devices that do not support the HLG format.

* Can only be set while [HDMI] is selected.

Anamorphic Recording

- [\[Anamorphic Desqueeze Display\]: 498](#)







From a variety of different video formats (recording qualities), you can select and record with a recording quality that suits anamorphic recording. During anamorphic recording, it is also possible to display desqueezed images and the angle of view when cropping after desqueeze editing. It is also possible to switch to an image stabilizer that suits anamorphic recording.

- For information about image stabilizers suited to anamorphic recording ([→\[Anamorphic \(Video\)\]: 299](#))

1 Set [Rec. File Format].

-  → [] → [] → [Rec. File Format]

2 Select a recording quality suited to anamorphic recording.

-  → [] → [] → [Rec Quality]
- The following recording qualities are available in [] mode:
 - [Rec Quality] exceeding a resolution of C4K
 - [Rec Quality] with a high frame rate video exceeding a recording frame rate of 60.00p
- When [Rec. File Format] is set to [MOV] or [Apple ProRes], by filtering [Rec Quality] by the number of pixels, you can display just those recording qualities with resolutions and aspect ratios that meet the conditions. (→ [\[Filtering\]: 156](#))



- This camera is not compatible with desqueeze editing of video recorded with anamorphic recording. Use compatible software.

[Anamorphic Desqueeze Display]



Display the desqueezed images suited to the magnification of the anamorphic lens on this camera.

Using the [Frame Marker], it is also possible to superimpose on display the frame of the angle of view when cropping after desqueeze editing.

1 Set the recording mode to [M].

- Set the mode dial. (→ [Selecting the Recording Mode: 82](#))

2 Set [Anamorphic Desqueeze Display].

- → [] → [] → [Anamorphic Desqueeze Display]

[] ([2.0×])

[] ([1.8×])

[] ([1.5×])

[] ([1.33×])

[] ([1.30×])

[OFF]

- Make settings to suit the magnification of the anamorphic lens you are using.



3 Set [Frame Marker].

-  →  →  → [Frame Marker] (→ [\[Frame Marker\]: 460](#))

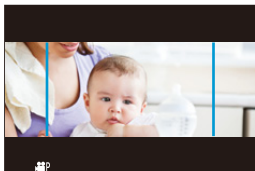

- Images output via HDMI are not desqueezed.
- When the following function is being used, [Anamorphic Desqueeze Display] is not available:
 - [Proxy Recording]

[Synchro Scan(Video)]









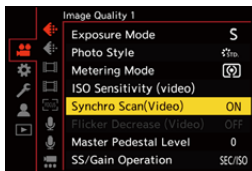

Fine-adjust the shutter speed to reduce flickering and horizontal stripes. The shutter speed set in Synchro Scan is saved separately from the shutter speed used for normal recording.

In the Synchro Scan setting screen you can call up the current shutter speed for normal recording and adjust it.

- 1 **Set the recording mode to [M].**
 - Set the mode dial. (→ [Selecting the Recording Mode: 82](#))
- 2 **Set the exposure mode to [S] or [M].**
 - → → → [Exposure Mode] → [S]/[M]
- 3 **Set [Synchro Scan(Video)].**
 - → → → [Synchro Scan(Video)] → [ON]



4 Set the shutter speed.

- Rotate ,  or  to select a numeric value, then press  or .
- The shutter speed can be set in the range between 1 second and 1/8192.0 of a second.
(The minimum shutter speed depends on the frame rate of the video being recorded.)
- Press   to change the shutter speed in 1/4 TV intervals. Press   to make fine adjustments.
- You can call up the current shutter speed for normal recording by pressing [DISP.].
- Adjust the shutter speed while looking at the screen so that flickering and horizontal stripes will be minimized.



- There may be a difference between what you see on the recording screen and the actual results of recording. We recommend shooting some tests beforehand.

[Loop Recording (video)]



Recording continues until the card becomes full, while dividing videos into short periods.

When the card becomes full, recording continues while deleting the old data.

This is a convenient function for recording over long periods that might exceed the capacity of the card.





- Recording and deleting occur at the same time, so you will need a card with a writing speed equivalent to double the bit rate of the recording quality used for recording.

If the writing speed on the card is insufficient, recording may stop.





1 Set the recording mode to [M].

- Set the mode dial. (→ [Selecting the Recording Mode: 82](#))

2 Set [Rec. File Format] to [MOV].

-  → [] → [] → [Rec. File Format] → [MOV]

3 Set [Loop Recording (video)].

-  → [] → [] → [Loop Recording (video)] → [ON]
- [] is displayed on the recording screen.
- When the recording fills the card to capacity, loop recording starts and video recording time is no longer displayed.





- Make sure the camera does not turn off during recording.
- Loop recording cannot start if there is insufficient available capacity on the card.
- When the recording time exceeds 12 hours, recording continues with data being deleted in order from the point where recording started.
- When [Video File Name] is set to [CINE Style], recording stops when the number of folders and number of files reach the maximum.

If loop recording is to be done over long periods, we recommend setting [Video File Name] to [Same As Photo(DCF Standard)].

- When the following functions are being used, [Loop Recording (video)] is not available:
 - [Rec Quality] with a bit rate of 400 Mbps or more
 - [Variable Frame Rate]
 - [Proxy Recording]
 - [Live Cropping]

[Segmented File Recording]



To avoid video loss due to unforeseen interruptions to the power supply, recorded video is segmented at set intervals while being recorded.

- The segmented videos are saved as one group image. (→ [Group Images: 567](#))

1 Set [Rec. File Format] to [MOV] or [Apple ProRes].

- → [] → [] → [Rec. File Format] → [MOV]/[Apple ProRes]

2 Set [Segmented File Recording].

- → [] → [] → [Segmented File Recording] → [10MIN.]/[5MIN.]/[3MIN.]/[1MIN.]



- When the following function is being used, [Segmented File Recording] is not available:
 - [Loop Recording (video)]

List of Recording Qualities That Enable Special Videos to be Recorded

VFR : Recording qualities that enable use of [Variable Frame Rate]

HFR : Recording qualities for High Frame Rate video

Live Crop : Recording qualities that enable use of [Live Cropping]

HLG : Recording qualities with which you can record HLG video

ARRI LogC3 : Recording qualities that enable use of the [ARRI LogC3] ([Photo Style])

The function can be used only when you have used the Upgrade Software Key (DMW-SFU3A: optional) and enabled the function with [Activate]. (→[\[Activate\]: 692](#))

❖ [Rec. File Format]: [MP4]

[System Frequency]: [59.94Hz (NTSC)]

[Rec Quality]	VFR	HFR	Live Crop	HLG	ARRI LogC3
[4K/10bit/100M/60p]			✓	✓	
[4K/10bit/72M/30p]			✓	✓	
[4K/8bit/100M/30p]			✓		
[4K/10bit/72M/24p]				✓	
[4K/8bit/100M/24p]					
[FHD/8bit/28M/60p]			✓		
[FHD/8bit/20M/30p]			✓		
[FHD/8bit/24M/24p]					

[System Frequency]: [50.00Hz (PAL)]

[Rec Quality]	VFR	HFR	Live Crop	HLG	ARRI LogC3
[4K/10bit/100M/50p]			✓	✓	
[4K/10bit/72M/25p]			✓	✓	
[4K/8bit/100M/25p]			✓		
[FHD/8bit/28M/50p]			✓		
[FHD/8bit/20M/25p]			✓		

❖ [Rec. File Format]: [MOV]

[System Frequency]: [59.94Hz (NTSC)]

[Rec Quality]	VFR	HFR	Live Crop	HLG	ARRI LogC3
[5.8K/30p/420/10-L]				✓	✓
[5.8K/24p/420/10-L]				✓	✓
[5.7K/60p/420/10-L]				✓	✓
[5.7K/48p/420/10-L]		✓		✓	✓
[5.7K/30p/420/10-L]				✓	✓
[5.7K/24p/420/10-L]				✓	✓
[4.4K/60p/420/10-L]				✓	✓
[4.4K/48p/420/10-L]		✓		✓	✓
[C4K/120p/420/10-L]		✓		✓	✓
[C4K/60p/422/10-I(H)]				✓	✓
[C4K/60p/422/10-I(L)]				✓	✓
[C4K/60p/422/10-L]				✓	✓
[C4K/60p/420/10-L]	✓			✓	✓
[C4K/60p/420/8-L]					
[C4K/48p/422/10-I(H)]		✓		✓	✓
[C4K/48p/422/10-I(L)]		✓		✓	✓
[C4K/48p/422/10-L]		✓		✓	✓
[C4K/48p/420/10-L]		✓		✓	✓
[C4K/30p/422/10-I]	✓			✓	✓
[C4K/30p/422/10-L]				✓	✓
[C4K/30p/420/10-L]	✓			✓	✓
[C4K/30p/420/8-L]					
[C4K/24p/422/10-I]	✓			✓	✓
[C4K/24p/422/10-L]				✓	✓
[C4K/24p/420/10-L]	✓			✓	✓
[C4K/24p/420/8-L]					
[4K/120p/420/10-L]		✓		✓	✓
[4K/60p/422/10-I(H)]				✓	✓

[4K/60p/422/10-I(L)]				✓	✓
[4K/60p/422/10-L]			✓	✓	✓
[4K/60p/420/10-L]	✓		✓	✓	✓
[4K/60p/420/8-L]			✓		
[4K/48p/422/10-I(H)]		✓		✓	✓
[4K/48p/422/10-I(L)]		✓		✓	✓
[4K/48p/422/10-L]		✓		✓	✓
[4K/48p/420/10-L]		✓		✓	✓
[4K/30p/422/10-I]	✓			✓	✓
[4K/30p/422/10-L]			✓	✓	✓
[4K/30p/420/10-L]	✓		✓	✓	✓
[4K/30p/420/8-L]			✓		
[4K/24p/422/10-I]	✓			✓	✓
[4K/24p/422/10-L]			✓	✓	✓
[4K/24p/420/10-L]	✓		✓	✓	✓
[4K/24p/420/8-L]			✓		
[FHD/240p/422/10-I]		✓		✓	✓
[FHD/240p/422/10-L]		✓		✓	✓
[FHD/240p/420/10-L]		✓		✓	✓
[FHD/120p/422/10-I]		✓		✓	✓
[FHD/120p/422/10-L]		✓		✓	✓
[FHD/120p/420/10-L]		✓		✓	✓
[FHD/60p/422/10-I]	✓			✓	✓
[FHD/60p/422/10-L]			✓	✓	✓
[FHD/60p/420/10-L]	✓		✓	✓	✓
[FHD/60p/420/8-L]			✓		
[FHD/60i/422/10-I]				✓	✓
[FHD/60i/422/10-L]				✓	✓
[FHD/48p/422/10-I]		✓		✓	✓
[FHD/48p/422/10-L]		✓		✓	✓
[FHD/48p/420/10-L]		✓		✓	✓
[FHD/30p/422/10-I]	✓			✓	✓

[FHD/30p/422/10-L]			✓	✓	✓
[FHD/30p/420/10-L]	✓		✓	✓	✓
[FHD/30p/420/8-L]			✓		
[FHD/24p/422/10-L]	✓			✓	✓
[FHD/24p/422/10-L]			✓	✓	✓
[FHD/24p/420/10-L]	✓		✓	✓	✓
[FHD/24p/420/8-L]			✓		

[System Frequency]: [50.00Hz (PAL)]

[Rec Quality]	VFR	HFR	Live Crop	HLG	ARRI LogC3
[5.8K/25p/420/10-L]				✓	✓
[5.7K/50p/420/10-L]				✓	✓
[5.7K/25p/420/10-L]				✓	✓
[4.4K/50p/420/10-L]				✓	✓
[C4K/100p/420/10-L]		✓		✓	✓
[C4K/50p/422/10-I(H)]				✓	✓
[C4K/50p/422/10-I(L)]				✓	✓
[C4K/50p/422/10-L]				✓	✓
[C4K/50p/420/10-L]	✓			✓	✓
[C4K/50p/420/8-L]					
[C4K/25p/422/10-I]	✓			✓	✓
[C4K/25p/422/10-L]				✓	✓
[C4K/25p/420/10-L]	✓			✓	✓
[C4K/25p/420/8-L]					
[4K/100p/420/10-L]		✓		✓	✓
[4K/50p/422/10-I(H)]				✓	✓
[4K/50p/422/10-I(L)]				✓	✓
[4K/50p/422/10-L]			✓	✓	✓
[4K/50p/420/10-L]	✓		✓	✓	✓
[4K/50p/420/8-L]			✓		
[4K/25p/422/10-I]	✓			✓	✓
[4K/25p/422/10-L]			✓	✓	✓
[4K/25p/420/10-L]	✓		✓	✓	✓
[4K/25p/420/8-L]			✓		

[FHD/200p/422/10-I]		✓		✓	✓
[FHD/200p/422/10-L]		✓		✓	✓
[FHD/200p/420/10-L]		✓		✓	✓
[FHD/100p/422/10-I]		✓		✓	✓
[FHD/100p/422/10-L]		✓		✓	✓
[FHD/100p/420/10-L]		✓		✓	✓
[FHD/50p/422/10-I]	✓			✓	✓
[FHD/50p/422/10-L]			✓	✓	✓
[FHD/50p/420/10-L]	✓		✓	✓	✓
[FHD/50p/420/8-L]			✓		
[FHD/50i/422/10-I]				✓	✓
[FHD/50i/422/10-L]				✓	✓
[FHD/25p/422/10-I]	✓			✓	✓
[FHD/25p/422/10-L]			✓	✓	✓
[FHD/25p/420/10-L]	✓		✓	✓	✓
[FHD/25p/420/8-L]			✓		

[System Frequency]: [24.00Hz (CINEMA)]

[Rec Quality]	VFR	HFR	Live Crop	HLG	ARRI LogC3
[5.8K/24p/420/10-L]				✓	✓
[5.7K/48p/420/10-L]		✓		✓	✓
[5.7K/24p/420/10-L]				✓	✓
[4.4K/48p/420/10-L]		✓		✓	✓
[C4K/120p/420/10-L]		✓		✓	✓
[C4K/24p/422/10-I]	✓			✓	✓
[C4K/24p/422/10-L]				✓	✓
[C4K/24p/420/10-L]	✓			✓	✓
[C4K/24p/420/8-L]					
[4K/120p/420/10-L]		✓		✓	✓
[4K/24p/422/10-I]	✓			✓	✓
[4K/24p/422/10-L]			✓	✓	✓
[4K/24p/420/10-L]	✓		✓	✓	✓
[4K/24p/420/8-L]			✓		
[FHD/120p/422/10-I]		✓		✓	✓
[FHD/120p/422/10-L]		✓		✓	✓
[FHD/120p/420/10-L]		✓		✓	✓
[FHD/24p/422/10-I]	✓			✓	✓
[FHD/24p/422/10-L]			✓	✓	✓
[FHD/24p/420/10-L]	✓		✓	✓	✓
[FHD/24p/420/8-L]			✓		

❖ [Rec. File Format]: [Apple ProRes]

[System Frequency]: [59.94Hz (NTSC)]

[Rec Quality]	VFR	HFR	Live Crop	HLG	ARRI LogC3
[5.7K/30p/RAW HQ]					
[5.7K/30p/RAW]					
[5.7K/30p/422 HQ]				✓	✓
[5.7K/30p/422]				✓	✓
[5.7K/24p/RAW HQ]					
[5.7K/24p/RAW]					
[5.7K/24p/422 HQ]				✓	✓
[5.7K/24p/422]				✓	✓
[C4K/60p/RAW HQ]					
[C4K/60p/RAW]					
[C4K/60p/422 HQ]				✓	✓
[C4K/60p/422]				✓	✓
[C4K/30p/RAW HQ]					
[C4K/30p/RAW]					
[C4K/30p/422 HQ]				✓	✓
[C4K/30p/422]				✓	✓
[C4K/24p/RAW HQ]					
[C4K/24p/RAW]					
[C4K/24p/422 HQ]				✓	✓
[C4K/24p/422]				✓	✓
[FHD/60p/422 HQ]				✓	✓
[FHD/60p/422]				✓	✓
[FHD/30p/422 HQ]				✓	✓
[FHD/30p/422]				✓	✓
[FHD/24p/422 HQ]				✓	✓
[FHD/24p/422]				✓	✓

[System Frequency]: [50.00Hz (PAL)]

[Rec Quality]	VFR	HFR	Live Crop	HLG	ARRI LogC3
[5.7K/25p/RAW HQ]					
[5.7K/25p/RAW]					
[5.7K/25p/422 HQ]				✓	✓
[5.7K/25p/422]				✓	✓
[C4K/50p/RAW HQ]					
[C4K/50p/RAW]					
[C4K/50p/422 HQ]				✓	✓
[C4K/50p/422]				✓	✓
[C4K/25p/RAW HQ]					
[C4K/25p/RAW]					
[C4K/25p/422 HQ]				✓	✓
[C4K/25p/422]				✓	✓
[FHD/50p/422 HQ]				✓	✓
[FHD/50p/422]				✓	✓
[FHD/25p/422 HQ]				✓	✓
[FHD/25p/422]				✓	✓

[System Frequency]: [24.00Hz (CINEMA)]

[Rec Quality]	VFR	HFR	Live Crop	HLG	ARRI LogC3
[5.7K/24p/RAW HQ]					
[5.7K/24p/RAW]					
[5.7K/24p/422 HQ]				✓	✓
[5.7K/24p/422]				✓	✓
[C4K/24p/RAW HQ]					
[C4K/24p/RAW]					
[C4K/24p/422 HQ]				✓	✓
[C4K/24p/422]				✓	✓
[FHD/24p/422 HQ]				✓	✓
[FHD/24p/422]				✓	✓

HDMI Output (Video)

You can record while outputting the camera images to an external monitor or external recorder connected with an HDMI cable.

- HDMI output control differs between during recording and during playback.

For HDMI output settings during playback (→[\[HDMI Connection\]: 688](#))

- [Connecting HDMI Devices: 518](#)
- [HDMI Output Image Quality: 519](#)
- [HDMI Output Settings: 527](#)
- [Output of RAW Video Data: 533](#)

Connecting HDMI Devices



- Check the direction of the terminals and plug in/out straight holding onto the plug. (Inserting at an angle can deform the terminal and cause malfunction.)
- Do not connect the cable to the wrong terminals. This may cause a malfunction.

Getting started:

- Turn off the camera and the external monitor/external recorder.

Connect the camera and an external monitor or external recorder with a commercially available HDMI cable.

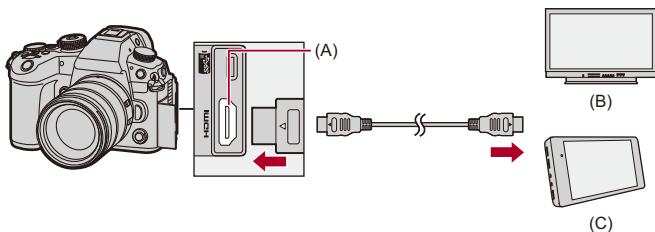

(A) HDMI socket (Type A)

(B) External monitor

(C) External recorder

- Use an Ultra High Speed HDMI cable (Type A–Type A plug) with the length less than 3 m (9.8 feet).

HDMI Output Image Quality

- [Images Output via HDMI: 519](#)
- [Settings for Down-Converting: 522](#)



Images Output via HDMI

The images output via HDMI during recording differ depending on the recording mode.

❖ [iA] Mode

Aspect ratio, resolution, and frame rate output is according to the [Rec Quality] settings in the [Video] ([Image Format]) menu. Resolution and frame rate can be down-converted for output according to the application. The YUV and bit value are output with YUV changed to 4:2:2 as shown below.

If the connected device is not compatible with the output system, output changes to match the connected device.

Recording to card	HDMI output
4:2:2 10 bit	4:2:2 10 bit
4:2:0 10 bit	4:2:2 10 bit
4:2:0 8 bit	4:2:2 8 bit

Resolution, frame rate

- Resolution and frame rate output is according to the following menu combinations:
 - [Rec Quality] in the [Video] ([Image Format]) menu.
 - [Down Convert] in [HDMI Rec Output] in the [Custom] ([IN/OUT]) menu.
- Video with a resolution exceeding 4K is output as C4K/4K resolution.
- When set to a [Rec Quality] for high frame rate video, the resolution and frame rate may be down-converted for output.
- For details (→ [Image Quality When Outputting via HDMI: 523](#))



- When set to a [Rec Quality] other than 16:9 or 17:9, bands are added to the images and they are output with a 16:9 aspect ratio.
- When [Rec Quality] is set to [C4K/60p/RAW HQ]/[C4K/60p/RAW] and [Proxy Recording] is set to [ON], output is performed via HDMI in FHD resolution.
- If you use the following functions, HDMI output stops when the video frame rate is 200p or more or when using [Proxy Recording]:
 - Wi-Fi connection with a smartphone
 - Tethered recording

❖ [iA]/[P]/[A]/[S]/[M] Mode

Output is the same as [M] mode during video recording.

Output is with a 16:9 aspect ratio during recording standby. Resolution, frame rate, YUV, and bit value output matches the connected device.



- When set to any [Aspect Ratio] other than 16:9, bands are added to the images and they are output with a 16:9 aspect ratio.

❖ Notice Regarding HDMI Output

- It may take some time for the output method to change.
- When you use the HDMI output during recording, the image may be displayed with a time lag.
- Beep sounds, AF beep, and electronic shutter sounds are muted during HDMI output.
- When you check the image and audio from the TV connected to the camera, the microphone of the camera may pick up the sound from the speakers of the TV, producing an abnormal sound (audio feedback).
If this occurs, move the camera away from the TV or lower the volume on the TV.
- Certain setting screens are not output via HDMI.
- **For information about the high temperature display (→ [For information about the high temperature display: 136](#))**

Settings for Down-Converting

Make settings for the down-conversion of resolution for HDMI output in the [iM] mode.

 →  →  → **[HDMI Rec Output]** → **Select [Down Convert]**

[AUTO]

Outputs by down-converting to match the connected device.

[C4K/4K]

Outputs by down-converting resolution to C4K/4K.

[1080p]

Down-converts resolution to FHD (1080), and outputs as progressive.

[1080i]

Down-converts resolution to FHD (1080), and outputs as interlaced.

[OFF]

Outputs at the resolution and recording frame rate of the [Rec Quality].



- The items you can select depend on the [System Frequency] setting.
- When set to a [Rec Quality] that is for high frame rate video with a resolution of 4K or more, the resolution and frame rate may be down-converted for output.
- If down-converting, AF may take longer than usual for focusing, and the performance of continuous focus tracking may deteriorate.

❖ Image Quality When Outputting via HDMI

Output is with the resolution and frame rate according to the combinations of the [Rec Quality] and [Down Convert] settings.

- When [Down Convert] is set to [AUTO], the output matches the connected device.
The maximum resolution and frame rate output when [AUTO] is set are the same as when [OFF] is selected.
- There is no HDMI output when setting combinations result in a [—] in the below tables.

[System Frequency]: [59.94Hz (NTSC)]

[Down Convert]	Resolution and recording frame rate of the [Rec Quality]			
	5.8K/29.97p 4K/29.97p	5.8K/23.98p 4.4K/47.95p 4K/47.95p 4K/23.98p	4.4K/59.94p 4K/59.94p	5.7K/59.94p C4K/59.94p
[C4K/4K]	4K/29.97p	4K/23.98p	4K/59.94p ^{*2}	C4K/59.94p ^{*2, 4}
[1080p]	1080/29.97p ^{*1}	1080/23.98p	1080/59.94p ^{*2}	1080/59.94p ^{*2}
[1080i]	1080/59.94i	—	1080/59.94i	1080/59.94i
[OFF]	4K/29.97p	4K/23.98p	4K/59.94p	C4K/59.94p

[Down Convert]	Resolution and recording frame rate of the [Rec Quality]			
	5.7K/47.95p 5.7K/23.98p C4K/47.95p C4K/23.98p	5.7K/29.97p C4K/29.97p	C4K/119.88p	4K/119.88p
[C4K/4K]	C4K/23.98p ^{*4}	C4K/29.97p ^{*4}		
[1080p]	1080/23.98p	1080/29.97p ^{*1}	1080/59.94p ^{*2}	1080/59.94p ^{*2}
[1080i]	—	1080/59.94i	1080/59.94i	1080/59.94i
[OFF]	C4K/23.98p	C4K/29.97p	1080/59.94p ^{*5}	1080/59.94p ^{*6}

[Down Convert]	Resolution and recording frame rate of the [Rec Quality]		
	1080/239.76p 1080/119.88p	1080/59.94p	1080/59.94i
[C4K/4K]	—	—	—
[1080p]	1080/119.88p ^{*3}	1080/59.94p ^{*2}	—
[1080i]	1080/59.94i	1080/59.94i	1080/59.94i
[OFF]	1080/119.88p	1080/59.94p	1080/59.94i

[Down Convert]	Resolution and recording frame rate of the [Rec Quality]	
	1080/47.95p 1080/23.98p	1080/29.97p
[C4K/4K]	—	—
[1080p]	1080/23.98p	1080/29.97p ^{*1}
[1080i]	—	1080/59.94i
[OFF]	1080/23.98p	1080/29.97p

*1 Output is 59.94p if the connected device is not compatible with 29.97p.

*2 Output is 29.97p if the connected device is not compatible with 59.94p.

*3 Output is 59.94p or 29.97p if the connected device is not compatible with 119.88p.

*4 Output is 4K if the connected device is not compatible with C4K.

*5 Output is C4K/119.88p if [4K/120p Output] is [ON].

*6 Output is 4K/119.88p if [4K/120p Output] is [ON].

[System Frequency]: [50.00Hz (PAL)]

[Down Convert]	Resolution and recording frame rate of the [Rec Quality]			
	5.8K/25.00p 4K/25.00p	4.4K/50.00p 4K/50.00p	5.7K/50.00p C4K/50.00p	5.7K/25.00p C4K/25.00p
[C4K/4K]	4K/25.00p	4K/50.00p ^{*2}	C4K/50.00p ^{*2,4}	C4K/25.00p ^{*4}
[1080p]	1080/25.00p ^{*1}	1080/50.00p ^{*2}	1080/50.00p ^{*2}	1080/25.00p ^{*1}
[1080i]	1080/50.00i	1080/50.00i	1080/50.00i	1080/50.00i
[OFF]	4K/25.00p	4K/50.00p	C4K/50.00p	C4K/25.00p

[Down Convert]	Resolution and recording frame rate of the [Rec Quality]		
	C4K/100.00p	4K/100.00p	1080/200.00p 1080/100.00p
[C4K/4K]			—
[1080p]	1080/50.00p ^{*2}	1080/50.00p ^{*2}	1080/100.00p ^{*3}
[1080i]	1080/50.00i	1080/50.00i	1080/50.00i
[OFF]	1080/50.00p ^{*5}	1080/50.00p ^{*6}	1080/100.00p

[Down Convert]	Resolution and recording frame rate of the [Rec Quality]		
	1080/50.00p	1080/50.00i	1080/25.00p
[C4K/4K]	—	—	—
[1080p]	1080/50.00p ^{*2}	—	1080/25.00p ^{*1}
[1080i]	1080/50.00i	1080/50.00i	1080/50.00i
[OFF]	1080/50.00p	1080/50.00i	1080/25.00p

*1 Output is 50.00p if the connected device is not compatible with 25.00p.

*2 Output is 25.00p if the connected device is not compatible with 50.00p.

*3 Output is 50.00p or 25.00p if the connected device is not compatible with 100.00p.

*4 Output is 4K if the connected device is not compatible with C4K.

*5 Output is C4K/100.00p if [4K/100p Output] is [ON].

*6 Output is 4K/100.00p if [4K/100p Output] is [ON].

[System Frequency]: [24.00Hz (CINEMA)]

[Down Convert]	Resolution and recording frame rate of the [Rec Quality]		
	5.8K/24.00p 4.4K/48.00p	5.7K/48.00p 5.7K/24.00p C4K/24.00p	C4K/120.00p
[C4K/4K]	4K/24.00p	C4K/24.00p ^{*1}	
[1080p]	1080/24.00p	1080/24.00p	1080/24.00p
[OFF]	4K/24.00p	C4K/24.00p	1080/24.00p ^{*3}

[Down Convert]	Resolution and recording frame rate of the [Rec Quality]	
	4K/120.00p	4K/24.00p
[C4K/4K]		4K/24.00p
[1080p]	1080/24.00p	1080/24.00p
[OFF]	1080/24.00p ^{*4}	4K/24.00p

[Down Convert]	Resolution and recording frame rate of the [Rec Quality]	
	1080/120.00p	1080/24.00p
[C4K/4K]	—	—
[1080p]	1080/120.00p ^{*2}	1080/24.00p
[OFF]	1080/120.00p	1080/24.00p

*1 Output is 4K if the connected device is not compatible with C4K.

*2 Output is 24.00p if the connected device is not compatible with 120.00p.

*3 Output is C4K/120.00p if [4K/120p Output] is [ON].

*4 Output is 4K/120.00p if [4K/120p Output] is [ON].

HDMI Output Settings

- [Outputting the Camera Information Display via HDMI: 528](#)
- [Outputting Control Information to an External Recorder: 529](#)
- [Outputting Audio via HDMI: 529](#)
- [Outputting the Enlarged Live Display \(Video\) via HDMI: 530](#)
- [Outputting as 4K/120p \(4K/100p\) via HDMI: 531](#)
- [\[4K/120p Power Save Live View\] \(\[4K/100p Power Save Live View\]\): 532](#)



Outputting the Camera Information Display via HDMI

Output the camera information display to an external device connected by HDMI.

 →  →  → **[HDMI Rec Output]** → **Select [Info Display]**

Settings: [ON]/[OFF]



- There is the following restriction when connected via HDMI and [Info Display] is set to [ON]:
 - [Touch Tab] is not available.

Outputting Control Information to an External Recorder

Recording start and stop control information is output to an external recorder connected by HDMI.

 → [] → [] → [HDMI Rec Output] → Select [HDMI Recording Control]

Settings: [ON]/[OFF]

- [HDMI Recording Control] can be set when [HDMI Time Code Output] is set to [ON] in [] mode. (→[HDMI Time Code Output]: 439)
- Control information is output when pressing the video rec. button or shutter button, even if the video cannot be recorded (such as when there is no card inserted into the camera).
- Only compatible external devices can be controlled.

Outputting Audio via HDMI

Output audio to an external device connected by HDMI.

 → [] → [] → [HDMI Rec Output] → Select [Sound Output (HDMI)]

Settings: [ON]/[OFF]

Outputting the Enlarged Live Display (Video) via HDMI

Output the enlarged screens from [MF Assist] or [Enlarged Live Display(Video)] to an external device connected by HDMI.

 → [] → [] → [HDMI Rec Output] → Select [Enlarged Live Display]

[MODE1]

Enlarged display of live view is output during standby for video recording.

- Resolution and frame rate output are the same as those set at [Down Convert].
- When [4K/120p Output] ([4K/100p Output]) is set to [ON] and the enlarged display of live view is used, the resolution and frame rate of the video is output via HDMI with C4K/120p (100p) or 4K/120p (100p), but the image refresh rate will be 30 fps or lower.

[MODE2]

Enlarged display of live view is output during standby for video recording and during video recording.

- The resolution and frame rate of the video output via HDMI will be FHD/60p or less.
- When [Down Convert] is set to [C4K/4K] or [OFF], [MODE2] is not available.
- When [4K/120p Output] ([4K/100p Output]) is set to [ON], [MODE2] is not available.

[OFF]

Enlarged display of live view is not output.

- When the monitor/viewfinder of the camera is displaying the enlarged display, the camera information display is not output via HDMI.
 - When [4K/120p Output] ([4K/100p Output]) is set to [ON] and the enlarged display of live view is used, the image refresh rate on the camera will be 30 fps or lower.
-

Outputting as 4K/120p (4K/100p) via HDMI

When set to a recording quality of C4K/120p (100p) or 4K/120p (100p), video is output to an external device connected via HDMI as C4K/120p (100p) or 4K/120p (100p).

 ➔  ➔  ➔ **[HDMI Rec Output]** ➔ **Select [4K/120p Output] ([4K/100p Output])**

[ON]

Output as C4K/120p (100p) or 4K/120p (100p) via HDMI.

If the external device is not compatible, output is FHD/60p or less.

- While outputting as C4K/120p (100p) or 4K/120p (100p) via HDMI, video cannot be recorded to cards.
- The YUV and bit value are output at 4:2:2 10-bit.
If the external device is not compatible, the output is at 4:2:0 10-bit.

[OFF]

Output as FHD/60p or less via HDMI.





- When the following function is being used, [4K/120p Output] ([4K/100p Output]) is not available:
 - [HDMI RAW Data Output]

[4K/120p Power Save Live View] ([4K/100p Power Save Live View])

When outputting C4K/120p (100p) or 4K/120p (100p) via HDMI, activation of the image sensor is limited during recording standby to reduce power consumption and keep the temperature from rising.

- This can be set when [HDMI Recording Control] and [4K/120p Output] ([4K/100p Output]) are [ON].

 ⇒  ⇒  ⇒ [HDMI Rec Output] ⇒ **Select [4K/120p Power Save Live View] ([4K/100p Power Save Live View])**

[ON]

Activation of the camera's image sensor is limited to C4K/60p (50p) or 4K/60p (50p) during recording standby.

The limitation is canceled when recording is started by pressing either the video rec. button or shutter button on the camera.

- The output destination device recognizes as C4K/120p (100p) or 4K/120p (100p), but if the recording is started on the external recorder during recording standby, recording is made with a limited image quality, so use the camera to perform the operations for starting and stopping video recording on the external recorder.

(→ [Outputting Control Information to an External Recorder: 529](#))

[OFF]

Output stays C4K/120p (100p) or 4K/120p (100p) via HDMI even during recording standby.



- The camera is released from the time code slave state when you use the [4K/120p Power Save Live View] ([4K/100p Power Save Live View]) function.

Output of RAW Video Data

- [Outputting RAW Video Data via HDMI: 535](#)
- [Notes When Outputting RAW Video Data: 540](#)



12-bit RAW Video Data with a maximum resolution of 5.8K can now be output via HDMI to a compatible external recorder.

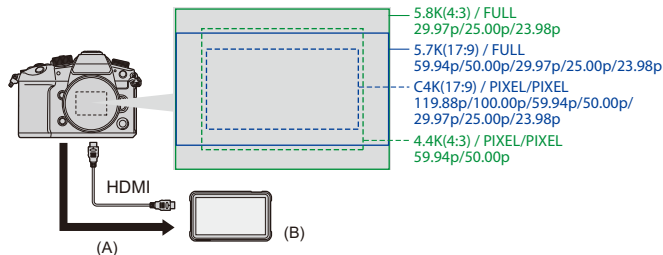

(A) RAW Video

(B) External recorder

- Recording of the RAW Video Data of this camera has been confirmed on the following external recorders. (As of May 2024)
 - ATOMOS: “NINJA V”/“NINJA V+”/“NINJA”/“NINJA ULTRA”/“SHOGUN”/“SHOGUN ULTRA”/“SHOGUN CONNECT”
 - Blackmagic Design: “Blackmagic Video Assist 5” 12G HDR”/“Blackmagic Video Assist 7” 12G HDR”

- For external recorder firmware versions that support recording of RAW Video Data, check the following site:
<https://panasonic.jp/support/global/cs/dsc/connect/index.html>
(English only)
- For details about external recorders, contact either ATOMOS or Blackmagic Design.
- This does not guarantee all of the capabilities that the compatible external recorder may have.
- You will need compatible software to edit the RAW Video Data recorded with the external recorder. Compatible software supports only V-Log/V-Gamut conversion.
- When editing RAW video data that was recorded with an ATOMOS recorder, in order to match the coloring with the V-Log/V-Gamut, download the LUT (Look-Up Table) file from the following support site and load it into the software.
- Visit the following site to download LUT file or view the latest support information:
<https://panasonic.jp/support/global/cs/dsc/>
(English only)



- Video cannot be recorded to cards while RAW Video Data is being output via HDMI.
- When [System Frequency] is set to [24.00Hz (CINEMA)], RAW Video Data cannot be output via HDMI.
- When the [Rec Quality] is set to 5.7K/60p (50p) or C4K/120p (100p) and recording to a Blackmagic Design recorder, it is recommended to set the codec quality on the recorder to the following:
 - When recording to an SSD: constant bitrate 5:1 or less
 - When recording to an SD card: constant bitrate 8:1 or less

Outputting RAW Video Data via HDMI

The image quality for the output images is set in [Rec Quality].

Getting started:

- 1 Turn off the camera and the external recorder.
- 2 Connect the camera and the external recorder with a commercially available HDMI cable.
 - Use an Ultra High Speed HDMI cable (Type A–Type A plug) with the length less than 3 m (9.8 feet).
- 3 Turn on the camera and the external recorder.

1 Set the recording mode to [M].

- Set the mode dial. (→ [Selecting the Recording Mode: 82](#))

2 Set [HDMI RAW Data Output].

-  → [] → [] → [HDMI RAW Data Output] → [ON]

- [HDMI RAW] is displayed on the recording screen.

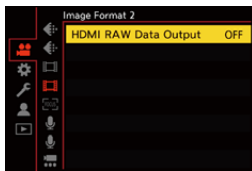

3 Select a recording quality.

-  →  →  → [Rec Quality]

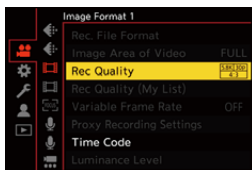

4 Set the HDMI input on the external recorder.

- When the connection is complete, images will be displayed on the screen of the external recorder.



There are differences from normal HDMI output operation.

- [HDMI Rec Output] in the [Custom] ([IN/OUT]) menu.
 - [Info Display] is not available. You cannot output the camera information display to an external recorder connected by HDMI.
 - [Down Convert] is not available. Outputs at the resolution and recording frame rate of the [Rec Quality].

❖ [Rec Quality] (When [HDMI RAW Data Output] is selected)

[Rec Quality]	[System Frequency]	[Image Area of Video]	Resolution	Frame rate
[5.8K/30p/4:3]*	59.94Hz(NTSC)	[FULL]	5760×4320	29.97p
[5.8K/24p/4:3]		[FULL]	5760×4320	23.98p
[5.7K/60p/17:9]*		[FULL]	5728×3024	59.94p
[5.7K/30p/17:9]		[FULL]	5728×3024	29.97p
[5.7K/24p/17:9]		[FULL]	5728×3024	23.98p
[4.4K/60p/4:3]*		[PIXEL/PIXEL]	4352×3264	59.94p
[C4K/120p/17:9]*		[PIXEL/PIXEL]	4096×2160	119.88p
[C4K/60p/17:9]		[PIXEL/PIXEL]	4096×2160	59.94p
[C4K/30p/17:9]		[PIXEL/PIXEL]	4096×2160	29.97p
[C4K/24p/17:9]		[PIXEL/PIXEL]	4096×2160	23.98p
[5.8K/25p/4:3]	50.00Hz(PAL)	[FULL]	5760×4320	25.00p
[5.7K/50p/17:9]*		[FULL]	5728×3024	50.00p
[5.7K/25p/17:9]		[FULL]	5728×3024	25.00p
[4.4K/50p/4:3]*		[PIXEL/PIXEL]	4352×3264	50.00p
[C4K/100p/17:9]*		[PIXEL/PIXEL]	4096×2160	100.00p
[C4K/50p/17:9]		[PIXEL/PIXEL]	4096×2160	50.00p
[C4K/25p/17:9]		[PIXEL/PIXEL]	4096×2160	25.00p

* Recording on the "NINJA V"/"NINJA"/"SHOGUN" is not available.

- Bit value: 12-bit
- Audio format: LPCM (2ch/4ch)
 - When the XLR Microphone Adaptor (DMW-XLR2: optional) is connected, if [4ch Audio Recording] is set to [XLR] or [XLR+CAMERA], 4-channel audio can be recorded.
- [Image Area of Video] is fixed to the image area according to the [Rec Quality] setting.
- [Sound Rec Quality] can be set to [96kHz/24bit] when you have connected an XLR Microphone Adaptor (DMW-XLR2: optional), Stereo Shotgun Microphone (DMW-MS2: optional), or Stereo Microphone (VW-VMS10: optional).

❖ **Monitor/Viewfinder Display When Outputting RAW Video Data**

Images equivalent to those recorded when recording with V-Log are displayed on the monitor/viewfinder of the camera for monitoring purposes. [LUT View Assist (Monitor)] with the [Vlog_709] preset applied can be used for the [Log View Assist].

- The LUT for the monitor display cannot be changed.
- When you use [LUT View Assist (Monitor)], [709] is displayed on the screen and [RAW] is displayed on the screen as a [LUT View Assist (HDMI)] item.
- [Luminance Spot Meter], and [BASE/RANGE] of [Zebra Pattern] are set at “Stop” units.
(18 % gray output level is calculated as 0 Stop)

Notes on displayed images



- The images displayed on the camera do not affect the RAW Video Data that is output.
- The images displayed on the external recorder are images that suit the external recorder specifications. This means that there may be differences between the images displayed on the camera and the images displayed on the external recorder.
- The monitor/viewfinder of the camera shows images with the angle of view of the RAW Video Data. There may be some difference with the angle of view of the data recorded on the external recorder.

❖ [HDMI Time Code Output]/[HDMI Recording Control]





The time code of the camera can be added and output via HDMI to the external recorder.

In addition, recording can be started and stopped on the external recorder by using the video rec. button and shutter button of the camera.

1 Set [HDMI Time Code Output] to [ON].



-  ⇒ [] ⇒ [] ⇒ [Time Code] ⇒ [HDMI Time Code Output] ⇒ [ON]

2 Set [HDMI Recording Control] to [ON].

-  ⇒ [] ⇒ [] ⇒ [HDMI Rec Output] ⇒ [HDMI Recording Control] ⇒ [ON]
- [HDMI Recording Control] can be set when [HDMI Time Code Output] is set to [ON] in [] mode.

Notes When Outputting RAW Video Data

Operation is as follows when outputting RAW Video Data:

- ISO sensitivity can be set in the range between [500] and [12800] (sensor output 60 fps or lower) or between [250] and [3200] (sensor output 61 fps or higher). You can set between [125] and [12800] when [Extended ISO] is set.
- The minimum shutter speed changes as follows when recording with MF and [Exposure Mode] is set to [M].
 - When [Rec Quality] is set to [C4K/120p/17:9]: can be set down to 1/125 of a second
 - When [Rec Quality] is set to [C4K/100p/17:9]: can be set down to 1/100 of a second
- [AWB], [AWBc], [AWBw] and [] cannot be used for white balance.
- [Photo Style] is fixed to [V-Log], and Image quality cannot be adjusted.
- [] of the AF mode is not available.
- Enlarging the display with [MF Assist] and [Enlarged Live Display(Video)] is not possible.
- The following functions are not available:
 - [Master Pedestal Level]
 - [i.Dynamic Range]
 - [Vignetting Comp.]
 - [Diffraction Compensation]
 - [Filter Settings]
 - [Rec. File Format]
 - [Filtering] and [add to list] in [Rec Quality]
 - [Rec Quality (My List)]
 - [Variable Frame Rate]
 - [Luminance Level]
 - [E-Stabilization (Video)] ([Image Stabilizer])
 - [Loop Recording (video)]
 - [Segmented File Recording]
 - [Color Bars]
 - [Streaming]

Using an External SSD

(Commercially Available)

Pictures and videos can be recorded and played back with a commercially available external SSD connected to the USB port of the camera.

There are recording qualities that can only be recorded to an external SSD.

- [Compatible External SSDs: 542](#)
- [Connecting the External SSD: 543](#)
- [Formatting the External SSD: 546](#)
- [Notes About External SSDs: 547](#)

Compatible External SSDs

This section describes the external SSDs that can be used with this camera. (As of May 2024)

External SSD compatible with USB Type-C® (no more than 2 TB in size)

- This camera is compatible with SuperSpeed USB 10Gbps (USB 3.2 Gen 2).
- We recommend using an external SSD whose operation has been confirmed by Panasonic.

Note beforehand that this is not a guarantee of operation on all devices.



- For the latest information about external SSDs, check the following support site:
<https://panasonic.jp/support/global/cs/dsc/connect/index.html>
(English only)
- This does not guarantee all of the capabilities that the external SSD whose operation has been verified may have.
- Perform trial recording in advance to check that operation is correct.
- Please also refer to the operating instructions for the external SSD.

Connecting the External SSD

Be sure to follow the below steps when connecting and removing the external SSD.

If you do not perform the steps as shown, the external SSD may not be recognized or the external SSD or recording data may be corrupted.

1 Set [USB-SSD] to [ON].

-  → [] → [] → [USB-SSD] → [ON]

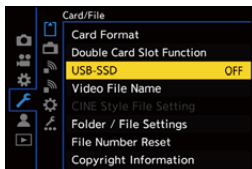

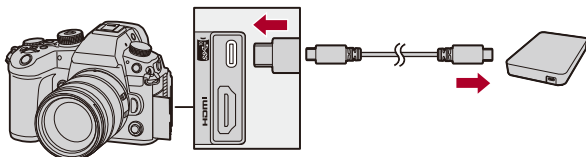

2 Connect the camera and external SSD with the USB connection cable.

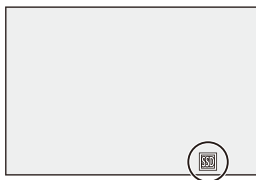

- Use the USB connection cable supplied with the external SSD.
- The USB-SSD icon is displayed on the screen when the camera recognizes the external SSD.



❖ Removing the External SSD

- 1 Set [USB-SSD] to [OFF].
 -  ⇒ [] ⇒ [] ⇒ [USB-SSD] ⇒ [OFF]
- 2 Confirm that the USB-SSD icon on the screen changes to the card icon, then unplug the USB connection cable from the camera.



- It may take a while for the external SSD to be recognized.
- When [USB-SSD] is set to [ON], you cannot use a card even if a card has been inserted. To use a card, set [USB-SSD] to [OFF].
- [] is displayed on the screen while writing to the external SSD.
- While the USB-SSD icon is being displayed on the screen, do not perform any of the following operations.

The camera may operate incorrectly or the external SSD and recorded images may be damaged.

- Disconnect the USB connection cable.
- Remove the battery or disconnect the power plug.
- Subject the camera or external SSD to vibration, impacts, or static electricity.

Formatting the External SSD

Format the external SSD with this camera before use.

 ➔ [] ➔ [] ➔ [USB-SSD Format]



- **When an external SSD is formatted, all of the data stored in the external SSD is erased and cannot be restored.**
Save a backup of necessary data before formatting the external SSD.
- Do not turn off the camera or perform another operation during formatting.
- Take care not to turn off the camera while formatting is in progress.
- If the external SSD has been formatted with a PC or other device, format it again with the camera.

Notes About External SSDs

- A Panasonic DC Coupler (DMW-DCC18: optional) is required to record the following types of video. (→[DC Coupler \(Optional\): 848](#))
 - [Rec Quality] with a high frame rate video exceeding a recording frame rate of 60.00p
 - [Variable Frame Rate] exceeding a frame rate of 60 fps
- When [USB-SSD] is set to [ON], the following functions are not available:
 - Recording to cards, playing back pictures/videos recorded to cards
 - [Double Card Slot Function]
 - [Streaming] ([USB Tethering]/[LAN] in [Connection Method])
 - [USB]
 - [Firmware Update] ([Firmware Version])
 - [Copy]
- If you want to automatically transfer pictures to a smartphone as they are taken while using an external SSD, set [USB-SSD] to [ON], then set [Auto Transfer] in [Bluetooth] to [ON]. (→[Auto Transfer: 759](#))
- When an external SSD is connected, power is supplied from the camera, so the battery will be consumed faster. It is recommended to either have a backup battery ready, or to use the Panasonic AC Adaptor (DMW-AC11: optional) and DC Coupler (DMW-DCC18: optional).
- **When not using the external SSD, turn [USB-SSD] [OFF].**
When set to [ON], power is supplied from the battery of this camera to the connected device, so the battery will be consumed faster.

- Depending on the external SSD connected, a message indicating that it cannot be used may be displayed on the screen due to insufficient power and it may not operate.
 - We recommend using an external SSD whose operation has been confirmed by Panasonic.
 - Perform trial recording in advance to check that operation is correct.
- When the temperature of the camera rises when recording over long periods to an external SSD, for example, [] appears blinking on the screen. If you continue to use the camera, a message indicating that the camera cannot be used is displayed on the screen and some functions, such as recording and HDMI output, will be stopped. Wait for the camera to cool down and for the message indicating that the camera can be used again. When the message indicating that it can be used again is displayed, turn the camera off then on again.
- The camera cannot access the external SSD if the external SSD is protected by a password, etc. Check the settings of the external SSD before use.
- Do not use USB extension cables, USB conversion adaptors, or USB hubs.

Playing Back and Editing of Images

This chapter explains how to play back and delete pictures and videos. You can also develop pictures recorded in the RAW format and repair video files that cannot be played back.

- Images recorded on devices other than this one may not be played back or edited correctly on this camera.
- [Playing Back Pictures: 550](#)
- [Playing Back Videos: 552](#)
- [Switching the Display Mode: 561](#)
- [Group Images: 567](#)
- [Deleting Images: 569](#)
- [\[RAW Processing\]: 571](#)
- [\[Video Repair\]: 580](#)
- [\[Playback\] Menu: 583](#)

Playing Back Pictures

1 Display the playback screen.

- Press [▶].

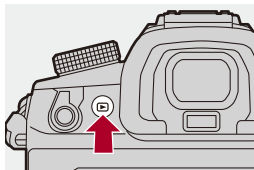

2 Select a picture.

- Select the pictures by pressing ◀▶.
- You can move continuously through images by pressing and holding ◀▶.
- You can also select by rotating 🌞 or ⚙️.
- You can also move through images by dragging the screen horizontally.



(A) Card slot

3 Stop playback.

- Press the shutter button halfway.
- You can also stop playback by pressing [▶].

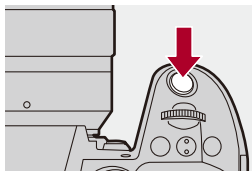

❖ Switching the Card to Display

You can switch the card displayed just by pressing [] during playback.

- You can also perform the same operation by pressing the Fn button assigned with [Card Slot Change]. (→ [Fn Buttons: 597](#))

- 1 Press [].
- 2 Press ▲▼ to select [Card Slot 1(CFexpress)] or [Card Slot 2(SD)] and then press  or .



- This camera complies with the “Design rule for Camera File system” (DCF) and “Exchangeable Image File Format” (Exif) standards established by “Japan Electronics and Information Technology Industries Association” (JEITA). The camera cannot play back files that do not comply with the DCF standard. Exif is a file format for pictures which allows recording information, etc. to be added.



- You can assign switching of the recording screen/playback screen to an Fn button:

(→ [\[Rec / Playback Switch\]: 606](#), [\[Rec / Playback Switch\]: 609](#))

Playing Back Videos

- [Video Repeat Playback: 556](#)
- [Extracting a Picture: 558](#)
- [\[Video Divide\]: 559](#)

1 Display the playback screen.

- Press [].

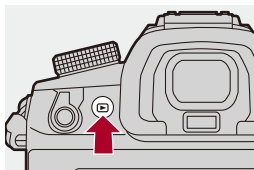

2 Select a video.

- For information about how to select images (→ [Playing Back Pictures: 550](#))
- The [] video icon is displayed for a video.
- The video recording time is displayed on the screen.
Example) When 8 minutes 30 seconds: 8m30s
- h: hour, m: minute, s: second

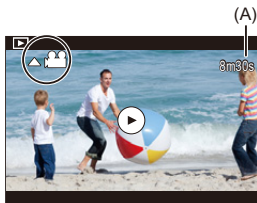

(A) Video recording time

3 Play back the video.



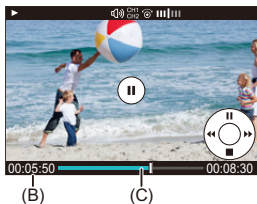









- Press ▲.
- You can also start playback by touching [▶] at the center of the screen.



4 Stop playback.

- Press ▼.

❖ Operations During Video Playback

Button operations	Touch operations	Description of operation
		Plays/pauses.
	—	Stops.
	—	Performs fast-rewind playback. • If you press  again, the fast-rewind speed increases.
		Performs frame-by-frame rewinding (while paused).
	—	Performs fast-forward playback. • If you press  again, the fast-forward speed increases.
		Performs frame-by-frame forwarding (while paused).
—		Selects the frame to display.
 / 		Extracts a picture (while paused). (→ Extracting a Picture: 558)
	—	Reduces the volume.
	—	Increases the volume.



- The camera can play back videos in MP4, MOV, and Apple ProRes formats.
- Fast-forward playback/fast-rewind playback (frame-by-frame forwarding/frame-by-frame rewinding) are not possible with RAW videos.
- The videos in the PRIVATE folder that were recorded with [Video File Name] set to [CINE Style] are also played back.
- Video recorded with a [System Frequency] setting that is different to the current one cannot be played back.
- If the reading speed of the card is slow, playback may pause or it may not be possible to play back smoothly.



- You may be able to repair video files that cannot be played back.
(→ [\[Video Repair\]: 580](#))
- You can set the operation for when playback of video finishes:
(→ [\[Behavior After Video Playback\]: 587](#))
- You can assign switching of the recording screen/playback screen to an Fn button:
(→ [\[Rec / Playback Switch\]: 606](#), [\[Rec / Playback Switch\]: 609](#))





Video Repeat Playback

You can play back a part of a video repeatedly.

1 Display the screen for setting the part to repeat.

- Press [Q] while paused.
- The screen for setting the part to repeat is also displayed when you touch [Repeat Playback] while paused.

2 Set the position to start the repeat.

- Press ◀▶ to select the start position and then press  or .
- Selection is also possible by rotating ,  or .
- You can also select the start position by touching the playback bar.

3 Set the position to end the repeat.

- Set using the same procedure as **2**.
- The position cannot be set if the position to start the repeat and the position to end the repeat are too close.

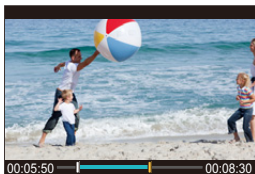

4 Start playback.

- The operations during repeat playback are the same as “[Operations During Video Playback](#)”. (→[Operations During Video Playback: 554](#))
- End repeat playback by pressing ▼ to stop playback or by pressing [Q] while paused.



- Repeat playback is not possible if the recording time is short.
- The positions set for the repeated part may shift from the position where the video is paused.

Extracting a Picture

Extract one frame of a video and save it as a JPEG image.

1 Pause playback at the position you wish to extract a picture.

- Press **▲**.
- To fine-adjust the position, press **◀▶** (rewind frame-by-frame or forward frame-by-frame).

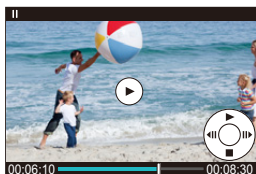

2 Save the picture.

- Press **MENU/SET** or **☺**.
- You can also save the picture by touching [Save].



- The picture created from the video is saved with a [FINE] picture quality. The picture is saved with a size according to the resolution of the [Rec Quality].
- The image quality of a picture created from a video may be coarser than normal.
- **[📷]** is displayed on the detailed information display screen for a picture created from a video.
- Pictures cannot be extracted when the following function is being used:
 - [Auto Transfer] (when there is an image queued to be transferred)
 - [Send Images to Frame.io] (when there is an image in the upload queue)

[Video Divide]

Divide a recorded video into two.



- Images cannot be returned to their original state once they have been divided. Carefully confirm the images before performing the divide operation.
- Do not remove the card or battery from the camera during the divide process. The images may be lost.

1 Select [Video Divide].

- Press **MENU/SET** → [**▶**] → [**✂**] → [Video Divide]

2 Select and play the image.



- Press **◀▶** to select an image and then press **MENU/SET** or **⌂**.

3 Pause playback at the position you wish to divide.

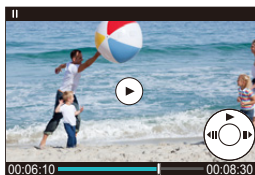
- Press **▲**.
- To fine-adjust the position, press **◀▶** (frame-by-frame rewind or frame-by-frame forward).



4 Divide the video.

- Press  or .
- You can also divide the video by touching [Divide].



- It is not possible to divide video that was recorded when [Rec. File Format] was [Apple ProRes].
- Dividing the video at a point close to the start or end may not be possible.
- Videos with a short recording time cannot be divided.
- [Video Divide] cannot be used on images recorded using [Segmented File Recording].
- [Video Divide] is not available when using the following functions:
 - [Auto Transfer] (when there is an image queued to be transferred)
 - [Send Images to Frame.io] (when there is an image in the upload queue)

Switching the Display Mode

- [Enlarged Display: 562](#)
- [Thumbnail Screen: 564](#)
- [Calendar Playback: 566](#)





You can use features to do things like enlarge recorded images for display and switch to thumbnail display to display multiple images at once (multi-playback).

You can also switch to calendar display to show images of a selected recording date.

Enlarged Display





Playback images can be displayed enlarged (Playback Zoom).

Enlarging the playback screen.

- Rotate  to the right.
- The playback screen is enlarged in the order of 2×  4×  8× 
16×.
- Rotating  to the left returns to the previous display size.
- Enlarged display to 16× may not be possible with images that have a small picture size.



❖ Operations During Enlarged Display

Button operations	Touch operations	Description of operation
	—	Enlarges/reduces the screen.
—	Pinch out/ pinch in	Enlarges/reduces the screen in small steps.
	Drag	Moves the enlarged display position. Positions can be moved to the diagonal directions using the joystick.
 / 	—	Forwards or rewinds images while maintaining the same zoom magnification and zoom position.









- You can display the point focused with AF. You can enlarge the display from that point:

(→ [\[Magnify from AF Point\]: 586](#))

Thumbnail Screen





1 Switch to thumbnail display.

- Rotate  to the left.
- The display is switched in the order of 12-image screen  30-image screen.
- Rotating  to the left during 30-image screen display switches to calendar display. (→ [Calendar Playback: 566](#))
- Rotating  to the right returns to the previous display.
- You can also switch the display by touching an icon.
 - []: 1-image screen
 - []: 12-image screen
 - []: 30-image screen
 - [CAL]: Calendar (→ [Calendar Playback: 566](#))



(A) Card slot

2 Select an image.

- Press    to select an image and then press  or .





- When you press [] while a thumbnail is being displayed, you can switch to the card being displayed.
- You can scroll the screen by dragging the thumbnail display up or down.



- Images indicated with [] cannot be played back.



Calendar Playback

1 Switch to calendar playback.







- Rotate  to the left.
- The display is switched in the order of thumbnail screen (12 images) ⇨ Thumbnail screen (30 images) ⇨ Calendar playback.
- Rotating  to the right returns to the previous display.



2 Select the recording date.

- Press    to select a date and then press  or .

3 Select an image.

- Press    to select an image and then press  or .
- Rotating  to the left returns to calendar playback.



- The card to display cannot be switched during calendar display.
- The range that the calendar can be displayed is January 2000 to December 2099.

Group Images

Images recorded with Time Lapse Shot or Stop Motion Shooting are handled as group images in the camera, and can be deleted and edited on a group basis.

(For example, if you delete a group image, all images in the group are deleted.)

You can also delete and edit each image in a group individually.

❖ Images Handled as Group Images by the Camera



Group images recorded with SH burst recording.



Group images recorded with Focus Bracket.



Group images recorded with Time Lapse Shot.



Group images recorded with Stop Motion Shooting.



Group images recorded with [Segmented File Recording].

❖ **Playing and Editing the Images in a Group One by One**

Operations such as displaying thumbnails and deleting images are available with images in groups just as with normal playback.

- 1 Select the group image in the playback state. (→ [Playing Back Pictures: 550](#))
- 2 Press ▼ to display the images in the group.
 - You can also perform the same operation by touching the group image icon.
- 3 Press ◀▶ to select an image.
 - To return to the normal playback screen, press ▼ or touch [▼▶] again.

Deleting Images



- Images cannot be restored once they have been deleted. Carefully confirm the images before deletion.
- You can only delete the images in the card of the selected card slot.
- If you delete a group image, all images in the group are deleted.

1 Press [⏻] in playback state.

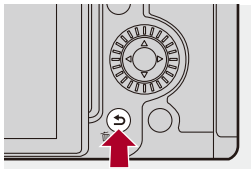

2 Press ▲▼ to select the deletion method and then press





 or .

[Delete Single]

Deletes the selected image.

[Delete Multi]

Selecting and deleting multiple images.

- 1 Press ▲▼◀▶ to select the image to delete and then press  or .
 - [] is displayed for the selected image.
 - If you press  or  again, the selection is canceled.
 - Up to 100 images can be selected.
- 2 Press [DISP.] to delete the selected image.



- To switch the card selected for deleting images, press [] and then select the card slot.



- Depending on the number of images to be deleted, it may take some time to delete them.
- Images cannot be deleted when the following function is being used:
 - [Auto Transfer] (when there is an image queued to be transferred)
 - [Send Images to Frame.io] (when there is an image in the upload queue)



- You can set which of [Yes] and [No] is selected initially in the confirmation screen when deleting:
 - (→ [\[Delete Confirmation\]: 595](#))
- All images on the card can be deleted:
 - (→ [\[Delete All Images\]: 595](#))

[RAW Processing]



This processes pictures taken in RAW format on the camera and saves them in JPEG format.

1 Select [RAW Processing].



-  → [] → [] → [RAW Processing]



2 Select the RAW image.



- Press ◀▶ to select an image and then press  or .
- When group images are selected, press ▼ and then select an image in the group.
Press ▼ again to return to the normal selection screen.
- The settings from the time of recording are reflected in displayed images.

3 Select a setting item.

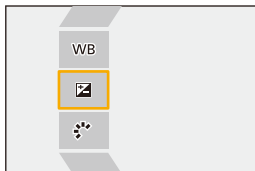
- Press ▲▼ to select an item and then press  or .





4 Change the setting.

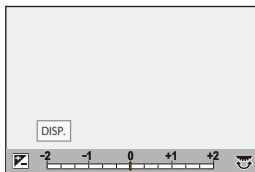

- Rotate , , or .
- The image can be enlarged/reduced by pinching out/pinching in the screen.



5 Confirm the setting.

- Press  or .
- The screen of Step 3 reappears.
To set another item, repeat Steps 3 to 5.

6 Save the image.

- Press ▲▼ to select [Begin Processing] and then press  or .

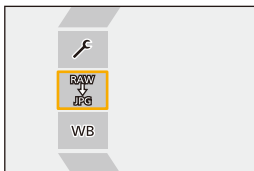

❖ Setting Items ([RAW Processing])



[Begin Processing]

Saves the image.

WB [White Balance]

Selects and adjusts the white balance.

Selecting the item with [] enables processing with the same setting as at the time of recording.

- If you press ▼ in the [White Balance] selection screen, the white balance adjustment screen appears. (→ [Adjusting the White Balance: 340](#))
 - If you press ▲ while [] to [] is selected, the color temperature setting screen appears. (→ [Color Temperature Setting: 339](#))
-

[Brightness correction]

Corrects the brightness.

- The [Brightness correction] effect differs from the effect of exposure compensation during recording.
-

[Photo Style] (→ [\[Photo Style\]: 342](#))

Selects a Photo Style.

- If you press [Q] while [Like709] is selected, the knee setting screen appears. (→ [Recording While Controlling Overexposure \(Knee\): 410](#))
 - You cannot select a Photo Style for images recorded with [V-Log]. You cannot select [V-Log] for images not recorded with [V-Log].
 - You cannot select a Photo Style other than [Cinelike D2] or [Cinelike V2] for images recorded with [Cinelike D2] or [Cinelike V2]. You cannot select [Cinelike D2] or [Cinelike V2] for images not recorded with Photo Style [Cinelike D2] or [Cinelike V2].
 - [REAL TIME LUT] cannot be selected. The Photo Styles that can be selected for images recorded with [REAL TIME LUT] depend on the base Photo Style.
-

 **[i.Dynamic Range]**

Selects the setting of [i.Dynamic Range].

 **[Contrast]**

Adjusts the contrast.

 **[Highlight]**

Adjusts the brightness of bright portions.

 **[Shadow]**

Adjusts the brightness of dark portions.

 **[Saturation]/[Color Tone]**

Adjusts the saturation or color tone.

 **[Hue]**

Adjusts the hue.

 **[Filter Effect]**

Selects filter effects.

 **[Grain Effect]**

Selects a grain effect setting.

 **[Color Noise]**

Adds color to the grain effect.

NR [Noise Reduction]

Sets noise reduction.

 **[Sharpness]**

Adjusts the sharpness.

LUT1 LUT2 [LUT]

Selects the LUT file registered in [LUT Library]. (→[LUT Library]: 364)

LUT1 LUT2 [LUT Opacity]

Adjusts the LUT file effect.

[More Settings]

[Revert To Original]: Returns the settings to the ones from the time of recording.

[Color Space]: Selects a Color Space setting from [sRGB] or [AdobeRGB]. (→[Color Space]: 632)

[Picture Size]: Selects the size for storing images.

[Destination Card Slot]: You can select the card slot to which to save images processed with RAW. When [AUTO] is selected, the image is saved to the same card slot as the RAW format image to be processed.

- The items that can be adjusted depend on the selected [Photo Style].

WB	✓	✓	✓	✓	✓
	✓	✓	✓	✓	✓
	✓	✓	✓	✓	
	✓	✓	✓		
	✓	✓	✓		
	✓	✓	✓		
	✓	✓	✓		
 ([Saturation])	✓	✓		✓	✓ ^{*1}
 ([Color Tone])			✓		
	✓	✓		✓	
			✓		
		✓	✓		✓ ^{*1}
		✓ ^{*2}			✓ ^{*1,2}
NR	✓	✓	✓	✓	✓
	✓	✓	✓	✓	✓
LUT1/	✓	✓	✓	✓	✓
LUT2/	✓	✓	✓	✓	✓

*1 Can be set when a LUT file is applied with [LUT1] or [LUT2].

*2 Can be set when [Grain Effect] is one of [Low], [Standard], or [High].



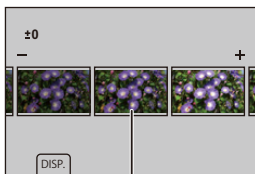

❖ Displaying a Comparison Screen

You can change a setting while checking the effect by displaying images with the applied setting value side by side.

- 1 Press [DISP.] in the screen of Step 4.
 - The image with the current setting (A) is displayed at the center.
 - Touching the image with the current setting enlarges it. Touching [↶] returns to the original display.
 - A comparison screen cannot be displayed while [Noise Reduction] or [Sharpness] is selected.



(A)

- 2 Rotate , , or  to change the setting.
- 3 Press  or  to confirm the setting.



- It may take a while for the comparison screen to be displayed.
- RAW images recorded with the camera are always recorded in the [L] size of [4:3].
(However, RAW images recorded in High Resolution mode are recorded in the [XL] size of [4:3])
- With this function, images are processed with the aspect ratio and the angle of view of [Crop Zoom(Photo)] from the time of recording.
- With RAW images recorded using [Crop Zoom(Photo)], the [Picture Size] that can be selected during processing may be different.
- [Picture Quality] is processed as [FINE] with this function.
- The results of RAW processing with this function and with the "SILKYPIX Developer Studio" software do not completely match.
- RAW processing is not possible while you are using the following function:
 - HDMI output
 - [Auto Transfer] (when there is an image queued to be transferred)
 - [Send Images to Frame.io] (when there is an image in the upload queue)

[Video Repair]

When the recording of a video could not be completed normally, a video file that cannot be played back may be generated (extension “.mdt”).

You can repair the “.mdt” file with this function to make it playable.

- Possible causes for the generation of “.mdt” files are:
 - Power turns off during video recording (battery is removed, AC cable is unplugged, power outage while using the AC adaptor, etc.)
 - Card removed during video recording
 - Card removed while writing to card after video recording
 - When an unexpected freeze occurs during video recording/while writing to the card





- Videos that can be repaired are those videos recorded with the [Rec. File Format] being either [MOV] or [Apple ProRes].
Video recorded in [MP4] cannot be repaired.
- As repairs can take some time, supply with power during the operation. (→ [Using the Camera While Supplying It with Power \(Supplying Power/Charging\): 56](#))

1 Select [Video Repair].



- → → → [Video Repair]



2 Select [Card Slot 1(CFexpress)] or [Card Slot 2(SD)].

- Press ▲▼ to select, and then press  or .
- Video files that can be repaired are filtered.

3 Select the video file to repair.

- Press ◀▶ to select a file and then press  or .
- Refer to the recording date and time (A), folder number (volume label)/file (clip) number (B), and video recording time (C) to help with selecting the video file.

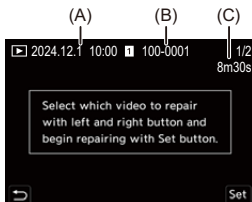



4 Select [Yes] on the confirmation screen.

- Video repair starts. Repair takes some time.
- The video file after repair is saved in the same folder as the file before repair.

❖ Canceling Video Repair

Even if you cancel video repair, the file is not deleted, so the procedure can be done over again later if required.

- 1 Press either  or  in the video repair progress screen.
- 2 Select [Yes] on the confirmation screen.



- It may not be possible to repair videos with a short recording time.
- It may not be possible to repair videos in some cases due to the state of the data.
- Video repair cannot be started if there is very limited free space on the card.
- Do not turn off the power or remove the card during repair.
Otherwise, the card and recorded data may be damaged.
- Do not perform other operations during the repair.
- You cannot repair videos recorded with devices other than this camera.
- When the following functions are being used, [Video Repair] is not available:
 - [Auto Transfer] (when there is an image queued to be transferred)

[Playback] Menu





- [How to Select an Image\(s\) in the \[Playback\] Menu: 583](#)
- [\[Playback\] \(\[Playback Mode\]\): 585](#)
- [\[Playback\] \(\[Process Image\]\): 588](#)
- [\[Playback\] \(\[Add/Delete Info.\]\): 589](#)
- [\[Playback\] \(\[Edit Image\]\): 590](#)
- [\[Playback\] \(\[Others\]\): 595](#)

How to Select an Image(s) in the [Playback] Menu

Follow the steps below when the image selection screen is displayed.







- Images are displayed separately by card slot.
- You can only select images on one card at a time.

❖ When [Single] Has Been Selected

- 1 Press ◀▶ to select the image.
- 2 Press  or .
 - If [Set/Cancel] is displayed at the right bottom of the screen, the setting is canceled when  or  is pressed again.

❖ When [Multi] Has Been Selected





When you press [], the card that is displayed is switched.

- Press    to select the image and then press  or  (repeat).
 - The setting is canceled when  or  is pressed again.



- Press [DISP.] to execute.

When [Protect] is selected

Press    to select the image, and then press  or  to set (repeat).

- The setting is canceled when  or  is pressed again.



[Playback] ([Playback Mode])

▶: Default settings

[Playback Mode]

▶[Normal Play] / [Picture Only] / [Video Only] / [Rating]

Filters the type of images to play back.

- When you have set [Rating], put a check mark in the rating level you want to display, then press [DISP.].

[Slide Show]

[All] / [Picture Only] / [Video Only] / [Rating]

Selects image types and plays them back at regular intervals in order.

- When you have set [Rating], put a check mark in the rating level you want to display, then press [DISP.].

[Start]: Starts slide show playback.

[Duration]: Sets repeat playback.

[Repeat]: Sets repeat playback.

Operations during slide show

▲: Plays/pauses (You can also perform the same operation by touching [▶] or

[⏸])

◀: Move to the previous image

▶: Move to the next image

▼: Ends the slide show

⊙: Adjusts the volume

- When [Video Only] is set, [Duration] is not available.

[Rotate Disp.]

▶[ON] / [OFF]

Automatically displays pictures vertically if they were recorded when holding the camera vertically.

[Picture Sort]

[FILE NAME] / ▶[DATE/TIME]

This sets the order in which the camera displays images during playback.

[FILE NAME]: Displays images by folder name/file name.

[DATE/TIME]: Displays images by recording date.

- If you insert another card, it may take some time to read all data, therefore pictures may not be displayed in the set order.

[Magnify from AF Point]

[ON] / ▶[OFF]

Displays the point focused with AF.

Enlarges the AF focus location when enlarging the image.

- The center of the image is enlarged for RAW images recorded in the High Resolution mode or when the image is not focused.

[LUT View Assist (Monitor)]

[ON] / ▶[OFF]

When playing back images recorded with [Photo Style] set to [V-Log]/[ARRI LogC3], this displays the images with LUT file applied on the monitor/viewfinder.

- This functions in tandem with [LUT View Assist (Monitor)] in [Log View Assist] in the [Custom] ([Monitor / Display (Video)]) menu. (→ [\[Log View Assist\]: 490](#))

[HLG View Assist (Monitor)]

[MODE1] / ▶[MODE2] / [OFF]

At recording or playback of HLG video, this converts their color gamut and brightness for display.

- This functions in tandem with [Monitor] in [HLG View Assist] in the [Custom] ([Monitor / Display (Video)]) menu. (→[\[HLG View Assist\]: 495](#))

[Anamorphic Desqueeze Display]

$2.0\times$ / $1.8\times$ / $1.5\times$ / $1.33\times$ / $1.30\times$ / ▶[OFF]

This displays the desqueezed images suited to the magnification of the anamorphic lens on this camera.

- This is linked with [Anamorphic Desqueeze Display] under the [Custom] ([Monitor / Display (Video)]) menu. (→[\[Anamorphic Desqueeze Display\]: 498](#))

[Behavior After Video Playback]

▶[End Playback] / [Pause At Last Frame]

Sets the operation for when playback of video finishes.

[End Playback]: Ends video playback and returns to the image selection screen.

[Pause At Last Frame]: Does not end video playback, but pauses on the final frame. To end video playback, press ▼.

[Playback] ([Process Image])



[RAW Processing]

Processes pictures taken in RAW format on the camera and saves them in JPEG format.

(→ [\[RAW Processing\]: 571](#))



[Time Lapse Video]

This creates videos from group images recorded with [Time Lapse Shot].

- 1 Press ◀▶ to select a [Time Lapse Shot] group and then press  or .
 - 2 Select the options for creating a video to combine the pictures into a video.
(→ [Time Lapse Shot/Stop Motion Animation Videos: 263](#))
- When [System Frequency] is set to [24.00Hz (CINEMA)], [Time Lapse Video] is not available.

[Stop Motion Video]

This creates videos from group images recorded with [Stop Motion Animation].

- 1 Press ◀▶ to select the Stop Motion Animation group and then press  or .
 - 2 Select the options for creating a video to combine the pictures into a video.
(→ [Time Lapse Shot/Stop Motion Animation Videos: 263](#))
- When [System Frequency] is set to [24.00Hz (CINEMA)], [Stop Motion Video] is not available.

[Playback] ([Add/Delete Info.])

[Protect]

[Single] / [Multi] / [Cancel]



You can set protection for images so that they will not be deleted by mistake. However, if you format the card, the protected images will also be deleted.

- For information about how to select images (→ [How to Select an Image\(s\) in the \[Playback\] Menu: 583](#))
- Be careful because the [Protect] setting may be disabled on a device other than this camera.

[Rating]

[Single] / [Multi] / [Cancel]

If you set any of the five different rating levels for images, you can do the following:

- Deleting all images except for those with ratings.
 - Use the file details view on a PC, etc., to check the rating level. (JPEG images only)
- 1 Select an image. (→ [How to Select an Image\(s\) in the \[Playback\] Menu: 583](#))
 - 2 Press ◀▶ to select a rating level (1 to 5) and then press  or .
 - When [Multi] is selected, repeat Steps 1 and 2.
 - To cancel the setting, set the rating level to [OFF].





[Playback] ([Edit Image])

▶: Default settings

[Resize]

[Single] / [Multi]

Reduce the picture size of JPEG images and save them as different images to enable them to be easily used for web pages or sent as email attachments.

- For information about how to select images (→ [How to Select an Image\(s\) in the \[Playback\] Menu: 583](#))
 - When [Single] is selected, after choosing the image, press ▲▼ to select the size, then press  or .
 - When [Multi] is selected, before choosing the images, press ▲▼ to select the size, then press  or .
- You can set up to 100 images at once with [Multi].
- The image quality of the resized image becomes lower.
- [Resize] is not available for images recorded using the following functions:
 - Video recording
 - Group images
 - [RAW] ([Picture Quality])
 - Pictures created from [C4K] video
 - [XS] ([Picture Size])

[Rotate]

Rotate images manually in 90° steps.

[]: Rotates 90° clockwise.

[]: Rotates 90° counter-clockwise.

- For information about how to select images (→ [How to Select an Image\(s\) in the \[Playback\] Menu: 583](#))
- When [Rotate Disp.] is [OFF], [Rotate] is not available.

[Video Divide]

Divide a recorded video into two.

(→ [\[Video Divide\]: 559](#))

[Copy]

[Copy Direction]

▶ [1 → 2] / [2 → 1]

[Select Copy] / [Copy All in Folder] / [Copy All in Card]



You can copy the images in one of the cards to the other card.

- Copied images will be saved in a new folder.

[Select Copy]: Copies selected images.

- 1 Select the copy origin folder (DCIM folder/PRIVATE folder (CINE Style)).
- 2 Select the folder containing the images to copy.
- 3 Select the images. (→ [How to Select an Image\(s\) in the \[Playback\] Menu: 583](#))

[Copy All in Folder]: Copies all images in a folder.

- 1 Select the copy origin folder (DCIM folder/PRIVATE folder (CINE Style)).
- 2 Select the folder to copy.
- 3 Check the images to be copied and then press  or  to execute copying.

[Copy All in Card]: Copies all images in the card.

- The images in the DCIM folder are saved to the DCIM folder in the copy destination and the images in the PRIVATE folder are saved to the PRIVATE folder in the copy destination.

Using the Fn button to copy images

If you press the Fn button with [Copy] assigned while playing back images one at a time, the image currently being played back will be copied to the other card. (→ [Fn Buttons: 597](#))

- Select the copy destination folder from the following options. In the case of group images, [Create a New Folder] is selected automatically.

[Same Folder Number as Source]: Copies to a folder with the same name as the folder of the image to be copied.

[Create a New Folder]: Creates a new folder with an incremented folder number and then copies the image to it.

[Select Folder]: Selects a folder to store the image and then copies the image to it.

- If the copy source is a PRIVATE folder, only [Create a New Folder] can be selected.
- You can set up to 100 images at once with [Select Copy].
- The [Protect] setting is not copied.
- Copying may take a while.
- When using the following combinations of cards, video copying is not available:
 - Copying from CFexpress cards to SD/SDHC memory cards

[Video Repair]

▶[Card Slot 1(CFexpress)] / [Card Slot 2(SD)]

When recording does not finish normally for some reason, it is possible to repair the video file. (→[\[Video Repair\]: 580](#))

[Playback] ([Others])

▶: Default settings

[Delete Confirmation]

["Yes" first] / ▶["No" first]

This sets which option, [Yes] or [No], will be highlighted first when the confirmation screen for deleting an image is displayed.

["Yes" first]: [Yes] is highlighted first.

["No" first]: [No] is highlighted first.

[Delete All Images]

▶[Card Slot 1(CFexpress)] / [Card Slot 2(SD)]

Deleting all images in a card.

- Images cannot be restored once they have been deleted. Carefully confirm the images before deletion.
- If you select [Delete All Non-rating], all images except those with a rating set are deleted.
- [Delete All Images] can be used when [Playback Mode] is set to [Normal Play].

Camera Customization

This chapter describes the customization function with which you can configure the camera to your preferred settings.

It also describes the [Custom] menu where you can make advanced settings for the camera operations and screen displays, and the [Setup] menu where you can make basic settings for the camera.

- [Fn Buttons: 597](#)
- [\[Dial Operation Switch\]: 612](#)
- [Quick Menu Customization: 615](#)
- [Custom Mode: 622](#)
- [\[Custom\] Menu: 627](#)
- [\[Setup\] Menu: 668](#)
- [My Menu: 698](#)

Fn Buttons





- [Register Functions to the Fn Buttons: 600](#)
- [Use the Fn Buttons: 611](#)

You can register functions to the Fn (Function) buttons. Additionally, you can register other functions to specialized buttons such as [WB] button, in the same way as with the Fn buttons.

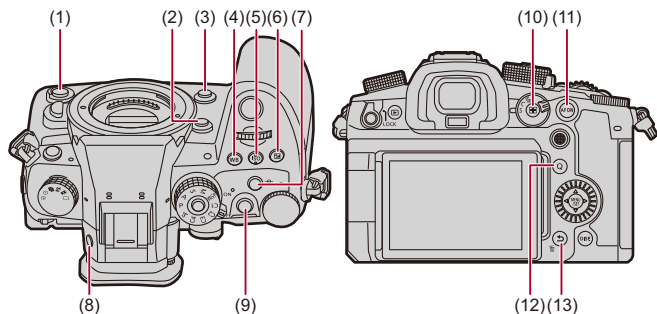
Different functions can be set for both during recording and playback.

❖ Fn Button Default Settings



Fn buttons	[Setting in REC mode]	[Setting in PLAY mode]
(1) Sub video rec. button	[Video Record]	[Video Record]
(2) [Fn2]	[AF-Point Scope]	[No Setting]
(3) [Fn3]	[Preview]	[No Setting]
(4) [WB]	[White Balance]	[No Setting]
(5) [ISO]	[Sensitivity]	[No Setting]
(6) []	[Exposure Comp.]	[No Setting]
(7) Audio information button	[Audio Information]	[No Setting]
(8) [LVF]	[LVF/Monitor Switch]	[LVF/Monitor Switch]
(9) Video rec. button	[Video Record]	[Video Record]
(10) []	[AF Mode]	[Card Slot Change]
(11) [AF ON]	[AF-ON]	[Rating★3]
(12) [Q]	[Q.MENU]	[Send Image (Smartphone)]
(13) [Fn1]/[]/ []	[Level Gauge]	<ul style="list-style-type: none"> • Cannot be used as Fn buttons during playback.

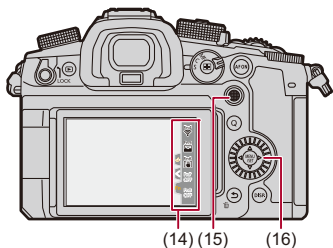

(14) (15) (16)

	Fn buttons	[Setting in REC mode]	[Setting in PLAY mode]
(14)	[Fn4]	[Wi-Fi]	
	[Fn5]	[Histogram]	
	[Fn6]	[Boost I.S. (Video)]	
	[Fn7]	[Off (Disable Press and Hold)]	
	[Fn8]	[Off (Disable Press and Hold)]	
(15)		[No Setting]	<ul style="list-style-type: none"> • Cannot be used as Fn buttons during playback.
(16)		[Zoom Control] (when using [Crop Zoom(Photo)])	

Register Functions to the Fn Buttons



- With default settings, [Fn13] to [Fn17] on the joystick cannot be used. When using functions, set the [Joystick Setting] in the [Custom] ([Operation]) menu to [Fn]. (→[Joystick Setting]: 645)

1 Select [Fn Button Set].





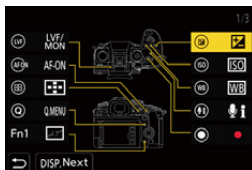

- Press → [] → [] → [Fn Button Set] → [Setting in REC mode]/ [Setting in PLAY mode]

2 Select the button.

- Press to select the button and then press or .
- Selection is also possible by rotating or .
- Press [DISP.] to change the page.







3 Find the function to register.

- Rotate  to select the sub tab where the function to register is categorized (→ [Setting Items \(\[Fn Button Set\]/\[Setting in REC mode\]\): 603](#), [Setting Items \(\[Fn Button Set\]/\[Setting in PLAY mode\]\): 609](#)) and then press  or .
- You can also select by pressing  to select the sub tab, pressing  or rotating , and then pressing .
- Switch the [1] to [3] tabs by pressing [Q].



4 Register the function.

- Press  to select a function and then press  or .
- Selection is also possible by rotating  or .
- Select items with [>] by selecting the item again.
- Depending on the button, some functions cannot be registered.



- You can also touch [**Fn**] on the control panel (→ [Control Panel: 858](#)) to display the screen in **Step 2**.
- You can also press and hold the Fn button (2 sec.) to display the screen in **Step 4**.
(This may not be displayed depending on the registered function and on the button type.)



- You can assign a function to the focus button of an interchangeable lens:
(→ [\[Lens Fn Button Setting\]: 665](#))

❖ Setting Items ([Fn Button Set]/[Setting in REC mode])

[1] tab

[Image Quality]

- [Exposure Comp.] (→ [Exposure Compensation: 322](#))
- [Sensitivity] (→ [ISO Sensitivity: 328](#))
- [White Balance] (→ [White Balance \(WB\): 334](#))
- [Photo Style] (→ [Photo Style: 342](#))
- [Apply LUT]
 - Applies the LUT file that was set in [LUT] with either [REAL TIME LUT] or [MY PHOTO STYLE]. (→ [Adjusting Image Quality: 348](#))
- [REAL TIME LUT] (→ [REAL TIME LUT: 362](#))
- [Metering Mode] (→ [Metering Mode: 303](#))
- [Aspect Ratio] (→ [Aspect Ratio: 124](#))
- [Picture Quality] (→ [Picture Quality: 127](#))
- [Picture Size] (→ [Picture Size: 125](#))
- [1 Shot Spot Metering]
 - Records with the metering mode set to [Metering Mode: 303)
- [Long Exposure NR] (→ [Long Exposure NR: 287](#))
- [Min. Shutter Speed] (→ [Min. Shutter Speed: 290](#))
- [1 Shot RAW+JPG]
 - Records a RAW image and a JPEG image simultaneously once only. (→ [Picture Quality: 127](#))
- [i.Dynamic Range] (→ [i.Dynamic Range: 325](#))
- [Filter Effect] (→ [Filter Settings: 356](#))
- [One Push AE]
 - Adjusts the aperture value and shutter speed to the settings suited for the standard exposure determined by the camera. (→ [Exposure Compensation: 322](#))
- [Touch AE] (→ [Touch AE: 118](#))
- [AWB Lock] (→ [AWB Lock Setting: 631](#))
- [Exposure Mode] (→ [Setting the Exposure for Recording Videos: 396](#))
- [Synchro Scan(Photo)] (→ [Synchro Scan\(Photo\): 288](#))
- [Synchro Scan(Video)] (→ [Synchro Scan\(Video\): 500](#))

 [Focus/Shutter]

- [AF Mode] (→ [Selecting the AF Mode: 189](#))
- [AF Detection Setting] (→ [Automatic Detection: 192](#))
- [Detecting Subject] (→ [Automatic Detection: 192](#))
- [AF Custom Setting(Photo)] (→ [\[AF Custom Setting\(Photo\)\]: 178](#))
- [AF Custom Setting(Video)] (→ [\[AF Custom Setting\(Video\)\]: 404](#))
- [Focus Limiter] (→ [\[Focus Limiter\]: 181](#))
- [Focus Limiter Range Set] (→ [\[Focus Limiter\]: 181](#))
- [Focus Peaking] (→ [\[Focus Peaking\]: 220](#))
- [Focus Peaking Sensitivity] (→ [\[Focus Peaking\]: 220](#))
- [Focus Frame Moving Speed] (→ [\[Focus Frame Moving Speed\]: 184](#))
- [Focus Ring Lock] (→ [\[Focus Ring Lock\]: 636](#))
- [AE LOCK] (→ [Locking Focus and Exposure \(AF/AE Lock\): 326](#))
- [AF LOCK] (→ [Locking Focus and Exposure \(AF/AE Lock\): 326](#))
- [AF/AE LOCK] (→ [Locking Focus and Exposure \(AF/AE Lock\): 326](#))
- [AF-ON] (→ [\[AF ON\] button: 173](#))
- [AF-ON : Near Shift]
 - AF operates giving priority to close-up subjects. (→ [Using AF: 171](#))
- [AF-ON : Far Shift]
 - AF operates giving priority to distant subjects. (→ [Using AF: 171](#))
- [AF-Point Scope] (→ [\[AF-Point Scope\]: 176](#))
- [Focus Area Set]
 - Displays the AF area/MF Assist movement screens. (→ [AF Area Operations: 206](#), [Operations on the MF Assist Screen: 217](#))
- [Enlarged Live Display(Video)] (→ [\[Enlarged Live Display\(Video\)\]: 405](#))

 [Flash]

- [Flash Mode] (→ [\[Flash Mode\]: 378](#))
- [Flash Adjust.] (→ [\[Flash Adjust.\]: 383](#))
- [Wireless Flash Setup] (→ [Recording Using a Wireless Flash: 386](#))

 **[Others (Photo)]**

- [Drive Mode Setting] (→ [Selecting the Drive Mode: 234](#))
- [Bracketing] (→ [Bracket Recording: 269](#))
- [Silent Mode] (→ [\[Silent Mode\]: 281](#))
- [Image Stabilizer] (→ [\[Operation Mode\]: 297](#))
- [Shutter Type] (→ [\[Shutter Type\]: 283](#))
- [Crop Zoom]
 - Can be set for [Crop Zoom(Photo)], [Zoom Control], [Zoom In(Tele)], [Zoom Out(Wide)], [Crop Zoom Increment(Step)], and [Zoom Speed(Photo)]. (→ [\[Crop Zoom\(Photo\)\]: 224](#))
- [Live View Composite] (→ [\[Live View Composite\]: 277](#))

[2] tab **[Image Format]**

- [Rec. File Format] (→ [\[Rec. File Format\]: 140](#))
- [Rec Quality] (→ [\[Rec Quality\]: 142](#))
- [Rec Quality (My List)] (→ [Setting or deleting in My List: 157](#))
- [Variable Frame Rate] (→ [Variable Frame Rate: 465](#))
- [Proxy Recording] (→ [Proxy Recording: 161](#))
- [Time Code Display] (→ [Time Code: 437](#))

 **[Audio]**

- [Audio Information] (→ [\[Audio Information\]: 423](#))
- [Sound Rec Level Disp.] (→ [\[Sound Rec Level Disp.\]: 414](#))
- [Mute Sound Input] (→ [\[Mute Sound Input\]: 415](#))
- [Sound Rec Level Adj.] (→ [\[Sound Rec Level Adj.\]: 417](#))
- [Sound Rec Quality] (→ [\[Sound Rec Quality\]: 418](#))
- [Sound Rec Level Limiter] (→ [\[Sound Rec Level Limiter\]: 420](#))
- [4ch Audio Recording] (→ [\[4ch Audio Recording\]: 432](#))
- [XLR Mic Adaptor Setting] (→ [XLR Microphone Adaptor \(Optional\): 429](#))
- [Sound Monitoring Channel] (→ [\[Sound Monitoring Channel\]: 435](#))

 **[Others (Video)]**

- [Image Stabilizer] (→[\[Operation Mode\]: 297](#))
- [E-Stabilization (Video)] (→[\[E-Stabilization \(Video\)\]: 298](#))
- [Boost I.S. (Video)] (→[\[Boost I.S. \(Video\)\]: 295](#))
- [Image Area of Video] (→[\[Image Area of Video\]: 166](#))
- [Crop Zoom]
 - Can be set for [Crop Zoom(Video)], [Zoom Control], [Zoom In(Tele)], [Zoom Out(Wide)], [Crop Zoom Increment(Step)], and [Zoom Speed(Video)]. (→[\[Crop Zoom\(Video\)\]: 228](#))
- [Focus Transition] (→[\[Focus Transition\]: 473](#))
- [Live Cropping] (→[\[Live Cropping\]: 478](#))
- [Live Cropping Settings] (→[\[Live Cropping\]: 478](#))

 **[Operation]**

- [Q.MENU] (→[Quick Menu: 97](#))
- [Rec / Playback Switch]
 - Switches to the playback screen. (→[Playing Back Pictures: 550](#), [Playing Back Videos: 552](#))
- [Video Record] (→[Basic Video Operations: 130](#))
- [Video Record(Creative Video)]
 - Video recording is started or stopped only in the [P_{CM}] mode. (→[Setting the Exposure for Recording Videos: 396](#))
- [LVF/Monitor Switch] (→[Switching Between the Monitor and Viewfinder: 91](#))
- [Dial Operation Switch] (→[Temporarily Change Dial Operation: 614](#))

🏠 [Monitor / Display]

- [Preview] (→[Preview Mode: 320](#))
- [Preview Aperture Effect]
 - The aperture effect can be previewed while the Fn button is being pressed.
(→[Preview Mode: 320](#))
- [Constant Preview] (→[Constant Preview: 647](#))
- [Level Gauge] (→[Level Gauge: 656](#))
- [Histogram] (→[Histogram: 648](#))
- [Luminance Spot Meter] (→[Luminance Spot Meter: 456](#))
- [Frame Marker] (→[Frame Marker: 460](#))
- [Photo Grid Line] (→[Photo Grid Line: 649](#))
- [Live View Boost] (→[Live View Boost: 649](#))
- [Monochrome Live View] (→[Monochrome Live View: 659](#))
- [Night Mode] (→[Night Mode: 650](#))
- [LVF/Monitor Disp. Set]
 - Switches the displayed monitor or viewfinder display style. (→[LVF/Monitor Disp. Set: 651](#))
- [Video-Priority Display] (→[Video-Priority Display: 661](#))
- [Zebra Pattern] (→[Zebra Pattern: 458](#))
- [LUT View Assist (Monitor)] (→[LUT View Assist \(Monitor\): 490](#))
- [LUT View Assist (HDMI)] (→[LUT View Assist \(HDMI\): 490](#))
- [LUT Select(LUT View Assist)] (→[Log View Assist: 490](#))
- [HLG View Assist (Monitor)] (→[HLG View Assist: 495](#))
- [HLG View Assist (HDMI)] (→[HLG View Assist: 495](#))
- [Sheer Overlay] (→[Sheer Overlay: 654](#))
- [I.S. Status Scope] (→[I.S. Status Scope: 655](#))
- [WFM/Vector Scope] (→[WFM/Vector Scope: 452](#))
- [Anamorphic Desqueeze Display] (→[Anamorphic Desqueeze Display: 498](#))
- [Color Bars] (→[Color Bars/Test Tone: 462](#))

[3] tab **[Lens / Others]**

- [Focus Ring Control] (→ [\[Focus Ring Control\]: 666](#))
- [AF Micro Adjustment] (→ [\[AF Micro Adjustment\]: 185](#))
- [Power Zoom Lens]
 - Can be set for [Zoom Control], [Zoom In(Tele)], [Zoom Out(Wide)], [Step Zoom], [Zoom Speed(Photo)] and [Zoom Speed(Video)]. (→ [Recording with Zoom: 222](#))
- [Lens Information] (→ [\[Lens Information\]: 300](#))

 **[Card/File]**

- [Destination Card Slot]
 - Changes the priority of cards for recording. This can be used if [Double Card Slot Function] (→ [\[Double Card Slot Function\]: 670](#)) is set to [Relay Rec].

 **[IN/OUT]**

- [Streaming] (→ [Streaming Function: 796](#))
- [Wi-Fi] (→ [Wi-Fi / Bluetooth: 715](#))
- [Fan Mode] (→ [\[Fan Mode\]: 663](#))

 **[Setting]**

- [Save to Custom Mode] (→ [Registering Instant Customization: 623](#))

 **[Others]**

- [No Setting]
 - Set when not using as an Fn button.
- [Off (Disable Press and Hold)]
 - The button does not work as an Fn button. The function registering screen is not displayed when you press and hold (2 seconds) the Fn button.
- [Restore to Default]
 - Restore the default settings for the Fn button. (→ [Fn Button Default Settings: 597](#))

❖ Setting Items ([Fn Button Set]/[Setting in PLAY mode])

[1] tab

[Playback Mode]

- [Magnify from AF Point] (→ [\[Magnify from AF Point\]: 586](#))
- [LUT View Assist (Monitor)] (→ [\[LUT View Assist \(Monitor\)\]: 586](#))
- [HLG View Assist (Monitor)] (→ [\[HLG View Assist \(Monitor\)\]: 587](#))
- [Anamorphic Desqueeze Display] (→ [\[Anamorphic Desqueeze Display\]: 498](#))

[Process Image]

- [RAW Processing] (→ [\[RAW Processing\]: 571](#))

[Add/Delete Info.]

- [Delete Single] (→ [Deleting Images: 569](#))
- [Protect] (→ [\[Protect\]: 589](#))
- [Rating★1] (→ [\[Rating\]: 589](#))
- [Rating★2] (→ [\[Rating\]: 589](#))
- [Rating★3] (→ [\[Rating\]: 589](#))
- [Rating★4] (→ [\[Rating\]: 589](#))
- [Rating★5] (→ [\[Rating\]: 589](#))

[Edit Image]

- [Copy] (→ [\[Copy\]: 592](#))

[Operation]

- [Rec / Playback Switch]
 - Switches to the recording screen. (→ [Basic Picture Operations: 121](#), [Basic Video Operations: 130](#))
- [LVF/Monitor Switch] (→ [Switching Between the Monitor and Viewfinder: 91](#))
- [Video Record] (→ [Basic Video Operations: 130](#))
- [Video Record(Creative Video)]
 - Video recording is started or stopped only in the [pM] mode. (→ [Setting the Exposure for Recording Videos: 396](#))

[Monitor / Display]

- [Night Mode] (→ [\[Night Mode\]: 650](#))

[Card/File]

- [Card Slot Change] (→ [Switching the Card to Display: 551](#))

[IN/OUT]

- [Sound Monitoring Channel(Play)] (→ [\[Sound Monitoring Channel\(Play\)\]: 684](#))
- [Wi-Fi] (→ [Wi-Fi / Bluetooth: 715](#))
- [Fan Mode] (→ [\[Fan Mode\]: 663](#))
- [Send Image (Smartphone)] (→ [Sending Images on the Camera to a Smartphone with Simple Operations: 747](#))
- [Send Images to Frame.io] (→ [\[Send Images to Frame.io\]: 793](#))
- [LUT View Assist (HDMI)] (→ [\[Log View Assist\]: 490](#))
- [HLG View Assist (HDMI)] (→ [\[HLG View Assist\]: 495](#))

[2] tab

[Others]





- [No Setting]
 - Set when not using as an Fn button.
- [Off (Disable Press and Hold)]
 - The button does not work as an Fn button. The function registering screen is not displayed when you press and hold (2 seconds) the Fn button.
- [Restore to Default]
 - Restore the default settings for the Fn button. (→ [Fn Button Default Settings: 597](#))

Use the Fn Buttons

During recording, pressing the Fn buttons enables usage of the functions registered in [Setting in REC mode], and during playback, usage of the functions registered in [Setting in PLAY mode].

1 Press the Fn button.

2 Select a setting item.

- Press ◀▶ to select a setting item and then press  or .
- Selection is also possible by rotating ,  or .
- Display and selection methods of a setting item differ depending on the menu item.

❖ Use [Fn4] to [Fn8] (Touch Icons)

During recording, you can use the Fn buttons within the Touch Tab.





- With the default settings, the Touch Tab is not displayed. Set [Touch Tab] to [ON] in [Touch Settings] in the [Custom] ([Operation]) menu. (→ [\[Touch Settings\]: 640](#))

- 1 Touch .
- 2 Touch one of [Fn4] to [Fn8].







[Dial Operation Switch]

- Register Functions to the Dials: 612
- Temporarily Change Dial Operation: 614

This temporarily changes the functions operated with  (front dial) and  (rear dial).

Register Functions to the Dials

1 Select [Dial Operation Switch Setup].

-  → [] → [] → [Dial Set.] → [Dial Operation Switch Setup] → []/[]

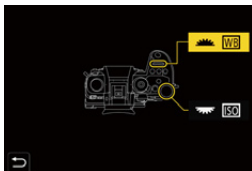

2 Register the function.

- Press   to select a function and then press  or .

❖ Functions That Can Be Registered

- [Exposure Comp.] (→ [Exposure Compensation: 322](#))
- [Sensitivity]^{*1} (→ [ISO Sensitivity: 328](#))
- [White Balance]^{*2} (→ [White Balance \(WB\): 334](#))
- [Photo Style] (→ [\[Photo Style\]: 342](#))
- [Aspect Ratio] (→ [\[Aspect Ratio\]: 124](#))
- [i.Dynamic Range] (→ [\[i.Dynamic Range\]: 325](#))
- [Filter Effect] (→ [\[Filter Settings\]: 356](#))
- [AF Mode] (→ [Selecting the AF Mode: 189](#))
- [Flash Mode] (→ [\[Flash Mode\]: 378](#))
- [Flash Adjust.] (→ [\[Flash Adjust.\]: 383](#))



*1  default setting

*2  default setting

Temporarily Change Dial Operation

1 Set [Dial Operation Switch] to the Fn button. (→Fn Buttons: 597)

2 Switch dial operation.

- Press the Fn button set in Step **1**.
- A guide will display the functions registered to  and .
- If no operations are performed, then several seconds later, the guide disappears.

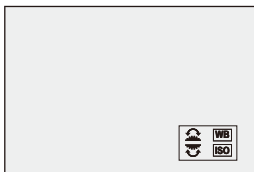

3 Set the registered function.

- Rotate  or  while the guide is displayed.

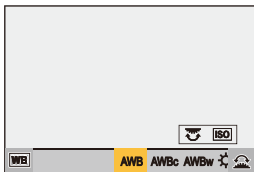

4 Confirm your selection.

- Press the shutter button halfway.

Quick Menu Customization

- [Register to the Quick Menu: 615](#)

You can change Quick menu items depending on the recording mode. Additionally, you can change the items to display on the Quick menu and their order to suit your preferences.



For information about Quick menu operation methods (→ [Quick Menu: 97](#))

Register to the Quick Menu







Change the menus to be displayed in the Quick menu.

These can be set separately for [M] mode (Video) and for other recording modes (Photo).

1 Select [Q.MENU Settings].





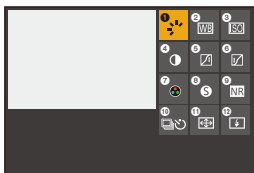

-  → [] → [] → [Q.MENU Settings] → [Item Customize (Photo)]/[Item Customize (Video)]

2 Select the item position (1 to 12).

- Press    to select the position and then press  or .
- Selection is also possible by rotating .
- Directions on the diagonal can also be selected using the joystick.







3 Find the function to register.

- Rotate  to select the sub tab where the function to register is categorized (→ [Menu Items That Can Be Registered: 617](#)) and then press  or .
- You can also select by pressing  to select the sub tab, pressing  or rotating , and then pressing .
- Each press of [Q] switches between tabs [1] and [2].



4 Register menu items.

- Press  to select an item and then press  or .
- Selection is also possible by rotating  or .
- Select items with [Q] by selecting the item again.

❖ Menu Items That Can Be Registered

[1] tab

[Image Quality]

- [Exposure Comp.] (→ [Exposure Compensation: 322](#))
- [Sensitivity] (→ [ISO Sensitivity: 328](#))
- [White Balance] (→ [White Balance \(WB\): 334](#))
- [Photo Style] (→ [\[Photo Style\]: 342](#))
- [Metering Mode] (→ [\[Metering Mode\]: 303](#))
- [Aspect Ratio] (→ [\[Aspect Ratio\]: 124](#))
- [Picture Quality] (→ [\[Picture Quality\]: 127](#))
- [Picture Size] (→ [\[Picture Size\]: 125](#))
- [Long Exposure NR] (→ [\[Long Exposure NR\]: 287](#))
- [Min. Shutter Speed] (→ [\[Min. Shutter Speed\]: 290](#))
- [i.Dynamic Range] (→ [\[i.Dynamic Range\]: 325](#))
- [Filter Effect] (→ [\[Filter Settings\]: 356](#))
- [Exposure Mode] (→ [Setting the Exposure for Recording Videos: 396](#))
- [Synchro Scan(Photo)] (→ [\[Synchro Scan\(Photo\)\]: 288](#))
- [Synchro Scan(Video)] (→ [\[Synchro Scan\(Video\)\]: 500](#))

[Focus/Shutter]

- [AF Mode] (→ [Selecting the AF Mode: 189](#))
- [AF Detection Setting] (→ [Automatic Detection: 192](#))
- [Detecting Subject] (→ [Automatic Detection: 192](#))
- [AF Custom Setting(Photo)] (→ [\[AF Custom Setting\(Photo\)\]: 178](#))
- [AF Custom Setting(Video)] (→ [\[AF Custom Setting\(Video\)\]: 404](#))
- [Focus Peaking] (→ [\[Focus Peaking\]: 220](#))
- [Focus Peaking Sensitivity] (→ [\[Focus Peaking\]: 220](#))
- [Focus Frame Moving Speed] (→ [\[Focus Frame Moving Speed\]: 184](#))

[Flash]

- [Flash Mode] (→[\[Flash Mode\]: 378](#))
- [Flash Adjust.] (→[\[Flash Adjust.\]: 383](#))
- [Wireless Flash Setup] (→[Recording Using a Wireless Flash: 386](#))

[Others (Photo)]

- [Drive Mode Setting] (→[Selecting the Drive Mode: 234](#))
- [Bracketing] (→[Bracket Recording: 269](#))
- [Silent Mode] (→[\[Silent Mode\]: 281](#))
- [Image Stabilizer] (→[\[Operation Mode\]: 297](#))
- [Shutter Type] (→[\[Shutter Type\]: 283](#))
- [Crop Zoom(Photo)] (→[\[Crop Zoom\(Photo\)\]: 224](#))
- [Zoom Speed(Photo)] (→[\[Zoom Speed\(Photo\)\]: 225](#))

[Image Format]

- [Rec. File Format] (→[\[Rec. File Format\]: 140](#))
- [Rec Quality] (→[\[Rec Quality\]: 142](#))
- [Rec Quality (My List)] (→[\[add to list\]: 157](#))
- [Variable Frame Rate] (→[Variable Frame Rate: 465](#))
- [Proxy Recording] (→[Proxy Recording: 161](#))
- [Time Code Display] (→[Time Code: 437](#))

[Audio]

- [Audio Information] (→[\[Audio Information\]: 423](#))
- [Sound Rec Level Disp.] (→[\[Sound Rec Level Disp.\]: 414](#))
- [Sound Rec Level Adj.] (→[\[Sound Rec Level Adj.\]: 417](#))
- [Sound Rec Quality] (→[\[Sound Rec Quality\]: 418](#))
- [Sound Rec Level Limiter] (→[\[Sound Rec Level Limiter\]: 420](#))
- [4ch Audio Recording] (→[\[4ch Audio Recording\]: 432](#))
- [XLR Mic Adaptor Setting] (→[XLR Microphone Adaptor \(Optional\): 429](#))
- [Sound Monitoring Channel] (→[\[Sound Monitoring Channel\]: 435](#))

[Others (Video)]

- [Image Stabilizer] (→[Operation Mode]: 297)
- [E-Stabilization (Video)] (→[E-Stabilization (Video)]: 298)
- [Boost I.S. (Video)] (→[Boost I.S. (Video)]: 295)
- [Image Area of Video] (→[Image Area of Video]: 166)
- [Crop Zoom(Video)] (→[Crop Zoom(Video)]: 228)
- [Zoom Speed(Video)] (→[Zoom Speed(Video)]: 229)
- [Focus Transition] (→[Focus Transition]: 473)
- [Live Cropping] (→[Live Cropping]: 478)

[2] tab

[Others (Video)]

- [Live Cropping Settings] (→[Live Cropping]: 478)

[Monitor / Display]

- [Constant Preview] (→[Constant Preview]: 647)
- [Level Gauge] (→[Level Gauge]: 656)
- [Histogram] (→[Histogram]: 648)
- [Luminance Spot Meter] (→[Luminance Spot Meter]: 456)
- [Frame Marker] (→[Frame Marker]: 460)
- [Photo Grid Line] (→[Photo Grid Line]: 649)
- [Live View Boost] (→[Live View Boost]: 649)
- [Monochrome Live View] (→[Monochrome Live View]: 659)
- [Night Mode] (→[Night Mode]: 650)
- [LVF/Monitor Disp. Set] (→[LVF/Monitor Disp. Set]: 651)
- [Video-Priority Display] (→[Video-Priority Display]: 661)
- [Zebra Pattern] (→[Zebra Pattern]: 458)
- [LUT View Assist (Monitor)] (→[LUT View Assist (Monitor)]: 490)
- [LUT View Assist (HDMI)] (→[LUT View Assist (HDMI)]: 490)
- [HLG View Assist (Monitor)] (→[HLG View Assist]: 495)
- [HLG View Assist (HDMI)] (→[HLG View Assist]: 495)

- [Sheer Overlay] (→[[Sheer Overlay](#)]: 654)
- [I.S. Status Scope] (→[[I.S. Status Scope](#)]: 655)
- [WFM/Vector Scope] (→[[WFM/Vector Scope](#)]: 452)
- [Anamorphic Desqueeze Display] (→[[Anamorphic Desqueeze Display](#)]: 498)
- [Color Bars] (→[[Color Bars/Test Tone](#)]: 462)

[Lens / Others]

- [Focus Ring Control] (→[[Focus Ring Control](#)]: 666)
- [Step Zoom] (→[[Step Zoom](#)]: 232)
- [Zoom Speed(Photo)] (→[[Zoom Speed\(Photo\)](#)]: 225)
- [Zoom Speed(Video)] (→[[Zoom Speed\(Video\)](#)]: 229)
- [Lens Information] (→[[Lens Information](#)]: 300)

[Card/File]

- [Destination Card Slot] (→[[Switching the Card to Display](#)]: 551)

[IN/OUT]



- [Streaming] (→[[Streaming Function](#)]: 796)
- [Wi-Fi] (→[[Wi-Fi / Bluetooth](#)]: 715)
- [Fan Mode] (→[[Fan Mode](#)]: 663)

[Others]

- [No Setting]
 - Set when not using.

❖ Quick Menu Detailed Settings

Change the appearance of the Quick menu and the operation of  during menu display.

 ⇒ [] ⇒ [] ⇒ Select [Q.MENU Settings]

[Layout Style]

Changes the appearance of the Quick menu.

[MODE1]: Displays the live view and the menu simultaneously.

[MODE2]: Displays the menu in full screen.

[Front Dial Assignment]

Changes the operation of  in the Quick menu.

[Item]: Selects menu items.

[Value]: Selects setting values.

[Item Customize (Photo)]

Customizes the Quick menu to display when the mode dial is set to [iA]/[P]/[A]/[S]/[M].

[Item Customize (Video)]

Customizes the Quick menu to display when the mode dial is set to [iM].

Custom Mode

- [Register in Custom Mode: 623](#)
- [Using Custom Mode: 625](#)
- [Calling Up Settings: 626](#)



Recording modes and menu settings that match your preferences can be registered in Custom mode. You can use registered settings by switching the mode dial to [C1] to [C4] modes.

Register in Custom Mode

You can register the currently set information of the camera.



At the time of purchase, the default settings of the [P] mode menus are registered with all Custom modes.

1 Set to recording mode and menu settings of the state you wish to save.

2 Select [Save to Custom Mode].

-  ⇒ [] ⇒ [] ⇒ [Save to Custom Mode]

3 Register.

- Select the save-to number and then press  or .
- A confirmation screen will be displayed. Press [DISP.] to change the Custom mode name.

How to enter characters (→ [Entering Characters: 108](#))

❖ Registering Instant Customization

When you press the Fn button registered with [Save to Custom Mode] in the recording standby screen, you can quickly register the current recording settings in the Custom mode. (→ [Fn Buttons: 597](#))



- You cannot register [iA] mode in Custom mode.



- List of settings that can be registered in Custom mode (→ [List of Default Settings/Custom Saving/Settings Available for Copying: 919](#))

❖ Custom Mode Detailed Settings

You can create additional Custom mode sets, and how long to retain temporarily changed settings details.

 ⇒ [] ⇒ [] ⇒ Select [Custom Mode Settings]

[Limit No. of Custom Mode]

Sets the number of Custom modes that can be registered in [C4].

A maximum of 10 sets can be registered; 3 sets are available as default settings.

[Edit Title]

Changes the Custom mode name.

A maximum of 22 characters can be entered. A two-byte character is treated as two characters.

- How to enter characters (→ [Entering Characters: 108](#))
-

[How to Reload Custom Mode]

Sets the timing at which to return the settings that were changed temporarily while the Custom mode was being used to their registered settings.

[Change Recording Mode]/[Return from Sleep Mode]/[Turn the Power ON]

[Select Loading Details]

Sets the types of settings to call up with [Load Custom Mode].

[F / SS / ISO Sensitivity]: Enables calling up of aperture value, shutter speed, and ISO sensitivity settings.

[White Balance]: Enables calling up of white balance settings.



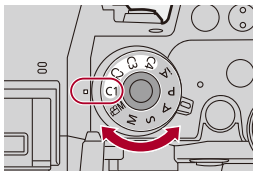

Using Custom Mode

Set the recording mode to [C1] to [C4].

- Set the mode dial. (→ [Selecting the Recording Mode: 82](#))
- If [C4], the last-used Custom mode will be called up.



❖ [C4] Custom Mode Selection

- 1 Set the recording mode to [C4].
- 2 Press .
 - The Custom mode selection menu appears.
- 3 Press  to select the Custom mode and then press  or .
 - The selected Custom mode icon will be displayed on the recording screen.



❖ Changing Registered Details

Registered settings do not change even if you change the camera settings temporarily with the mode dial set to [C1] to [C4].

To change the registered details, overwrite them by using [Save to Custom Mode] in the [Setup] ([Setting]) menu.

Calling Up Settings

Call up registered Custom mode settings to the selected recording mode and overwrite the current settings with these.



1 Set to the recording mode to be used.

- Set the mode dial. (→ [Selecting the Recording Mode: 82](#))

2 Select [Load Custom Mode].

-  → [] → [] → [Load Custom Mode]

3 Select the Custom mode to call up.

- Select the Custom mode and then press  or  .



- Calling up of Custom modes is not possible between those created from [P]/[A]/[S]/[M] modes and those created from [] mode.

[Custom] Menu

- [Custom] menu ([Image Quality]): 628
- [Custom] menu ([Focus/Shutter]): 634
- [Custom] menu ([Operation]): 640
- [Custom] menu ([Monitor / Display (Photo)]): 647
- [Custom] menu ([Monitor / Display (Video)]): 658
- [Custom] menu ([IN/OUT]): 662
- [Custom] menu ([Lens / Others]): 664

[Custom] menu ([Image Quality])

▶: Default settings

[Photo Style Settings]

[Show/Hide Photo Style]	[Vivid] / [Natural] / [L.ClassicNeo] / [Flat] / [Landscape] / [Portrait] / [L.Monochrome] / [L.Monochrome D] / [L.Monochrome S] / [LEICA Monochrome] / [Cinelike D2] / [Cinelike V2] / [Like709] / [V-Log] / [ARRI LogC3] / [REAL TIME LUT] / [Hybrid Log Gamma] / [MY PHOTO STYLE 1] to [MY PHOTO STYLE 10]
<p>Sets Photo Style items to be displayed on the menu.</p> <ul style="list-style-type: none"> • [ARRI LogC3] can be used only when you have used the Upgrade Software Key (DMW-SFU3A: optional) and enabled the function with [Activate]. (→[Activate]: 692) 	
[My Photo Style Settings]	[Add Effects]
	[Load Preset Setting]
<p>Enables detailed image quality adjustment settings for My Photo Style.</p> <p>[Add Effects]: Enables [Sensitivity] and [White Balance] settings in image quality adjustment.</p> <p>[Load Preset Setting]: Sets the timing at which image quality adjustment values changed in My Photo Style are returned to their registered state.</p>	
[Reset Photo Style]	
Returns details changed in [Photo Style] and [Photo Style Settings] to their default settings.	

[LUT Library]

[Vlog_709] / [ARRI 709] / [Sample LUT1] / [Sample LUT2] / [Sample LUT3] / [Set4]
to [Set39]

Registers LUT files to the camera.

(→ [\[LUT Library\]: 364](#))

- [ARRI 709] can be used only when you have used the Upgrade Software Key (DMW-SFU3A: optional) and enabled the function with [Activate]. (→ [\[Activate\]: 692](#))

[ISO Increments]

▶[1/3 EV] / [1 EV]

Changes the intervals between ISO sensitivity adjustment values.

[Extended ISO]

[ON] / ▶[OFF]

Extends the setting range of ISO sensitivity.

[Exposure Offset Adjust.]

[Multi Metering]	[-1EV] to [+1EV] (▶[±0EV])
[Center Weighted]	[-1EV] to [+1EV] (▶[±0EV])
[Spot]	[-1EV] to [+1EV] (▶[±0EV])
[Highlight Weighted]	[-1EV] to [+1EV] (▶[±0EV])

Adjusts the exposure level that is the standard exposure for each setting item of [Metering Mode].

Adds the adjustment value from this function to the exposure compensation value (→ [Exposure Compensation: 322](#)) when recording.

- For video recording, it is not possible to add an adjustment value of a range that exceeds ±3 EV.

[Face Priority In Multi Metering]

▶[ON] / [OFF]

When [Metering Mode] is set to [] (Multi-metering), the metering range for automatic exposure is prioritized on the eyes and face.

When set to [OFF], the change to exposure caused by the [Eye/Face] automatic detection function can be avoided.

[AWB Lock Setting]

[Operation Syncs With Shutter]	[WHILE PRESSING] / [DURING BURST SHOOTING] / ▶[OFF]
[Lock Hold With Fn Button]	▶[ON] / [OFF]

Fixes the white balance while you are pressing the shutter button or the Fn button when white balance is auto ([AWB]/[AWBc]/[AWBw]).

This prevents the white balance from changing unintentionally while pressing the shutter button halfway, during burst recording, or while recording videos.

[Operation Syncs With Shutter]

[WHILE PRESSING]: Fixes white balance while pressing the shutter button (including while pressing halfway or during burst recording).

[DURING BURST SHOOTING]: Fixes white balance during burst recording.

[OFF]: White balance is not fixed.

[Lock Hold With Fn Button]

[ON]: When you press the Fn button registered with [AWB Lock], the white balance is fixed. Press again to cancel the lock.

[OFF]: While you are pressing the Fn button registered with [AWB Lock], the white balance is fixed.

- [AWBL] is displayed on the screen while white balance is locked.
- [Operation Syncs With Shutter] does not work in [M] mode.

[Color Space]

▶[sRGB] / [AdobeRGB]

This sets the method for correcting the color reproduction of the recorded images on the screens of a PC or on a device such as a printer.

[sRGB]: This is widely used in PCs and similar devices.

[AdobeRGB]: AdobeRGB is mainly used for business purposes such as professional printing because it has a greater range of reproducible colors than sRGB.

- Set to [sRGB] if you are not very familiar with AdobeRGB.
- When the following functions are being used, the setting is fixed to [sRGB]:
 - Video recording
 - [Like709]/[V-Log]/[REAL TIME LUT] ([Photo Style])
 - [Filter Settings]

[Exposure Comp. Reset]

[ON] / ▶[OFF]

This resets the exposure value when you change the recording mode or turn off the camera.

[Auto Exposure in P/A/S/M]











▶[ON] / [OFF]

Selects the setting method for aperture value, shutter speed, and ISO sensitivity when recording video in the [P]/[A]/[S]/[M] modes.

[ON]: Records with values set automatically by the camera.

[OFF]: Records with the values set in the [P]/[A]/[S]/[M] modes.

[CreativeVideo Combined Set.]

[F/SS/ISO/Exposure Comp.]	▶[] / []
[White Balance]	▶[] / []
[Photo Style]	▶[] / []
[Metering Mode]	▶[] / []
[AF Mode]	▶[] / []
Content set in [ M] mode can be separated from when taking pictures. (→ Separating Settings for Recording Video and Pictures: 400)	

[Custom] menu ([Focus/Shutter])

▶: Default settings

[Focus/Shutter Priority]

[AFS]	▶[FOCUS] / [BALANCE] / [RELEASE]
[AFC]	[FOCUS] / ▶[BALANCE] / [RELEASE]

This sets whether to give priority to focus or shutter release during AF.

[FOCUS]: Disables recording when focus is not achieved.

[BALANCE]: Performs recording while controlling the balance between focusing and shutter release timing.

[RELEASE]: Enables recording even when focus is not achieved.

[Focus Switching for Vert / Hor]

[ON] / ▶[OFF]

This stores separate AF area positions (MF positions for MF Assist) for when the camera is held vertically and when it is held horizontally.

(→ [\[Focus Switching for Vert / Hor\]: 214](#))

[AF/AE Lock Hold]

[ON] / ▶[OFF]

This sets button operations for AF/AE Lock.

Turning this [ON] maintains the lock after releasing the button until it is pressed again.

[AF+MF]

[ON] / ▶[OFF]

When the focus mode is set to [AFS], you can fine-adjust the focus manually during AF Lock.

- When the shutter button is pressed halfway
- When [AF ON] is pressed
- When locked using the Fn button [AF LOCK] or [AF/AE LOCK]

[MF Assist]

[Focus Ring]

(When an interchangeable lens with a focus ring is attached)

▶[ON] / [OFF]

[AF Mode]

▶[ON] / [OFF]

[Press Joystick]

[ON] / ▶[OFF]

[MF Assist Display]

[FULL] / ▶[PIP]

This sets the display method of MF Assist (enlarged screen).

[Focus Ring]: The screen is enlarged by focusing with the lens.

[AF Mode]: The screen is enlarged by pressing [.].

[Press Joystick]: Press the joystick to enlarge the display. (if [Joystick Setting] is set to [D.FOCUS Movement]) (→ [\[Joystick Setting\]: 645](#))

[MF Assist Display]: Sets the display method (full screen mode/windowed mode) of MF Assist (enlarged screen).

[MF Guide][**m**] / [**ft.**] / [OFF]

* Default setting specifications vary depending on the country or area where the camera was purchased.

During MF, MF Guide, which acts as a guide to recording distance, is displayed on the screen. You can select from meters or feet for the display unit.

[Focus Ring Lock]

[ON] / ▶[OFF]

This disables the focus ring operation during MF to lock the focus.

- [MFL] is displayed on the recording screen while the focus ring is locked.

[Show/Hide AF Mode]

[Tracking]	▶[ON] / [OFF]
[Full Area AF]	▶[ON] / [OFF]
[Zone(Horizontal/Vertical)]	▶[ON] / [OFF]
[Zone]	▶[ON] / [OFF]
[1-Area+]	▶[ON] / [OFF]
[Pinpoint]	▶[ON] / [OFF]
Sets the AF mode items to be displayed on the AF mode selection screen.	

[Pinpoint AF Setting]

[Pinpoint AF Time]	[LONG] / ▶[MID] / [SHORT]
[Pinpoint AF Display]	[FULL] / ▶[PIP]
Changes enlarged screen settings displayed when AF mode is [+].	
<p>[Pinpoint AF Time]: Sets the time for which the screen is enlarged when the shutter button is pressed halfway.</p> <p>[Pinpoint AF Display]: Sets the display method (full screen mode/windowed mode) of the enlarged screen.</p>	

[AF-Point Scope Setting]

[Keep Enlarged Display]	[ON] / ▶[OFF]
[PIP Display]	[FULL] / ▶[PIP]
Changes the enlarged screen settings of AF-Point Scope (→[AF-Point Scope]: 176).	
<p>[Keep Enlarged Display]: Setting this to [ON] maintains the enlarged screen after pressing the Fn button until it is pressed again.</p> <p>[PIP Display]: Sets the display method (full screen mode^{*1}/windowed mode^{*2}) of the enlarged screen.</p> <p>*1 You can enlarge by approx. 3× to 10×.</p> <p>*2 You can enlarge by approx. 3× to 6×.</p> <ul style="list-style-type: none"> • When [Crop Zoom(Photo)] is [ON], the AF-Point Scope magnification rate is between about 3× to 6×. 	

[Shutter AF]

▶[ON] / [OFF]
This adjusts focus automatically when you press the shutter button halfway.

[Human Eye Detection Display]

▶[ON] / [OFF]

When set to [OFF], you can make the cross that appears on human eyes when focused disappear by pressing the shutter button halfway, etc.

[Half-Press Shutter]

[ON] / ▶[OFF]

You can release the shutter quickly by pressing the shutter button halfway.

[Assign REC to Shutter Button]

▶[ON] / [OFF]

Use the shutter button for the start/stop operation of video recording in the [COM] mode.

The start/stop operation of video recording using the shutter button can be disabled when set to [OFF].

[Quick AF]

[ON] / ▶[OFF]

When the amount of camera shake becomes small, the camera will automatically adjust the focus and focus adjustment will then be quicker when the shutter button is pressed.

- The battery will drain faster than usual.
- This function is not available in the following cases:
 - In preview mode
 - In low light situations

[Eye Sensor AF]

[ON] / ▶[OFF]

When looking through the viewfinder, if the eye sensor operates, then AF will function.

- [Eye Sensor AF] may not work in low light situations.

[Looped Focus Frame]

[ON] / ▶[OFF]

When moving the AF area, MF Assist, or video enlarged display of live view, this enables looping from one edge to the opposite edge of the screen.

[Enlarged Live Display(Video)]

[Keep Enlarged Display]

▶[ON] / [OFF]

[PIP Display]

[FULL] / ▶[PIP]

Sets the operation of the function for enlarging the video live view (→ [\[Enlarged Live Display\(Video\)\]: 405](#)).

[Keep Enlarged Display]

[ON]: Enlarges display after releasing the Fn button until the button is pressed again.

[OFF]: Enlarges display just while the Fn button is being pressed.

[PIP Display]

Sets the way the enlarged screen is displayed (full screen mode/windowed mode).

[Custom] menu ([Operation])

▶: Default settings

[Q.MENU Settings]

[Layout Style]	▶[MODE1] / [MODE2]
[Front Dial Assignment]	[Item] / ▶[Value]
[Item Customize (Photo)]	
[Item Customize (Video)]	
Customizes the Quick menu. (→ Quick Menu Customization: 615)	



[Touch Settings]

[Touch Screen]	▶[ON] / [OFF]
[Touch Tab]	[ON] / ▶[OFF]
[Touch AF]	▶[AF] / [AF+AE]
[Touch Pad AF]	[EXACT] / [OFFSET1] to [OFFSET7] / ▶[OFF]
Enables touch operation on the monitor display.	
<p>[Touch Screen]: All touch operations.</p> <p>[Touch Tab]: Operations of tabs, such as [] on the right side of the screen.</p> <p>[Touch AF]: Operation to optimize the focus ([AF]) for a touched subject. Alternatively, operation to optimize both the focus and brightness ([AF+AE]). (→ Focus on and Adjust Brightness for the Touched Position ([AF+AE]): 211)</p> <p>[Touch Pad AF]: Touch pad operation during viewfinder display. (→ Moving the AF Area Position with the Touch Pad: 212)</p>	

[Lock Lever Setting]

[AF ON] button	[] / ▶ []
Joystick	▶ [] / []
[Q] button	[] / ▶ []
Cursor buttons / [MENU/SET] button	▶ [] / []
Control dial	▶ [] / []
[] (AF mode) button	[] / ▶ []
[] (Playback) button	[] / ▶ []
Touch screen	▶ [] / []
[] (Cancel) button / [] (Delete) button / Fn button (Fn1)	[] / ▶ []
[DISP.] button	▶ [] / []
[] (Exposure compensation) button	[] / ▶ []
[ISO] button	[] / ▶ []
[] (Audio information) button	[] / ▶ []
Rear dial	▶ [] / []
Video rec. button	[] / ▶ []
Front dial	▶ [] / []
[WB] button	[] / ▶ []
[LVF] button	[] / ▶ []
Shutter button	[] / ▶ []
Sub video rec. button	[] / ▶ []
Lens	[] / ▶ []
Enlarged live display (video) button / Fn button (Fn2)	[] / ▶ []
Preview button / Fn button (Fn3)	[] / ▶ []

Sets the operations to be disabled with the operation lock lever. (Only for recording screen)

- The lock is applied or released each time you press .
- Press [DISP.] to change the page.
- The default settings are restored when you press [Q].
- [, X] is displayed on the screen when you try to operate an operation part that is locked.
- Operation parts locked by “Lens” depend on the lens. Lens switches are not locked.
- Even if the lens is operated while “Lens” is locked, [, X] does not get displayed on the screen.

After locking with the “Lens” setting, test whether the lock is working by trying to operate the lens.

[Fn Button Set]

[Setting in REC mode]

[Setting in PLAY mode]

Registers a function to the Fn button.

(→ [Register Functions to the Fn Buttons: 600](#))

[WB/ISO/Expo. Button]

[WHILE PRESSING] / [AFTER PRESSING1] / ▶[AFTER PRESSING2]

This sets the operation to be performed when [WB] (White balance), [ISO] (ISO sensitivity) or [] (Exposure compensation) is pressed.

[WHILE PRESSING]: Allows you to change the setting while pressing and holding the button. Release the button to confirm the settings value, and to return to the recording screen.

[AFTER PRESSING1]: Press the button to change settings. Press the button again to confirm the settings value, and to return to the recording screen.

[AFTER PRESSING2]: Press the button to change settings. Each press of the button switches the settings value. (Except that of exposure compensation) To confirm your selection and return to the recording screen, press the shutter button halfway.

[ISO Displayed Setting]

[Front/Rear Dials]	▶[ISO/ISO] / [ / ISO] / [OFF/ISO] / [ISO/ ] / [ISO/OFF]
--------------------	--

This sets the operations of the dials in the setting screen for ISO sensitivity. Assigning [] lets you change [ISO Auto Upper Limit Setting].

[Exposure Comp. Disp. Setting]

[Cursor Buttons (Up/Down)]	[] / ▶[OFF]
----------------------------	--

















This sets the operations of the ▲▼ buttons in the exposure compensation screen. Assigning [] lets you set exposure bracketing.

[Front/Rear Dials]	▶[ / ] / [ / ] / [OFF/ ] / [ / ] / [ /OFF]
--------------------	--

This sets the operations of the dials in the exposure compensation screen. Assigning [] lets you adjust flash output.

[Dial Set.]

[Assign Dial (F/SS)]		▶[SET1] / [SET2] / [SET3] / [SET4] / [SET5]			
Sets the operations to be assigned to the dials in [P]/[A]/[S]/[M] modes.					
P/⚡: Program Shift, F: Aperture value, SS: Shutter speed					
		[P]	[A]	[S]	[M]
[SET1]		P/⚡	F	SS	F
		P/⚡	F	SS	SS
[SET2]		—	F	—	F
		P/⚡	—	SS	SS
[SET3]		—	—	SS	SS
		P/⚡	F	—	F
[SET4]		—	—	—	F
		P/⚡	F	SS	SS
[SET5]		P/⚡	F	SS	F
		—	—	—	SS
[Rotation (F/SS)]		▶ ↻ / ↻			
Changes the rotational directions of the dials for aperture value and shutter speed adjustment.					
[Control Dial Assignment]		▶ ([Headphone Volume]) / ▶ / ([Exposure / Aperture]) / ▶ ([Exposure Comp.]) / ▶ ([Sensitivity]) / ▶ ([Focus Frame Size])			
Sets the function to be assigned to on the recording screen.					
▶ / : In [M] mode, this assigns the operation to adjust the aperture value. In other than [M] mode, this assigns the operation of exposure compensation.					

[Exposure Comp.]	[] / [] / ▶[OFF]
Assigns exposure compensation to  or  . (Except in [M] mode)	
• The [Assign Dial (F/SS)] setting takes priority.	
[Dial Operation Switch Setup]	[]
	[]
In the Fn button [Dial Operation Switch], this sets the functions to be registered temporarily to  or  . (→ Register Functions to the Dials: 612)	
[Rotation (Menu Operation)]	▶[] / [] / [] / [] / [] / [] / [] / []
Changes the rotational direction of the dials when operating menus.	

[Joystick Setting]

▶[D.FOCUS Movement] / [Fn] / [MENU] / [OFF]
Sets the joystick movement on the recording screen.
[D.FOCUS Movement]: Moves the AF area and MF Assist. (→ AF Area Operations: 206 , Record Using MF: 215)
[Fn]: Operates as Fn buttons.
[MENU]: Operates as  . Operations that can be performed by moving the joystick are disabled.
[OFF]: Disables the joystick.

[Video Rec. Button (Remote)]

You can register a favorite function to the video rec. button on a Shutter Remote Control (optional).

(→ [Shutter Remote Control \(Optional\): 845](#))

- [Video Record] is registered in the default setting.

[Custom] menu ([Monitor / Display (Photo)])

▶: Default settings

[Auto Review]

[Duration Time (photo)]	[HOLD] / [5SEC] to [0.5SEC] / ▶[OFF]
[Playback Operation Priority]	[ON] / ▶[OFF]
<p>This displays an image immediately after it is recorded.</p> <p>[Duration Time (photo)]: Sets the Auto Review when taking pictures.</p> <p>[Playback Operation Priority]: When this is set to [ON], you can toggle the playback screen during Auto Review, or delete pictures.</p> <ul style="list-style-type: none"> • If you set [Duration Time (photo)] to [HOLD], the image recorded stays displayed until the shutter button is pressed halfway. [Playback Operation Priority] will be fixed to [ON]. 	

[Constant Preview]

[ON] / ▶[OFF]	
[SET]	[Effect]
	[Preview While MF Assist]
<p>You can always confirm the effects of aperture on the recording screen when in [A]/[M] mode.</p> <p>You can also confirm the shutter speed at the same time when in [M] mode.</p> <ul style="list-style-type: none"> • You can set the combination of the aperture effect and the shutter speed effect in [Effect]. • Preview also operates in the MF Assist screen when [Preview While MF Assist] is set to [ON]. • The preview of the shutter speed effect does not work when using a flash. 	

[Histogram]

[ON] / ▶[OFF]

This displays the histogram.

Turning this [ON] displays the histogram transition screen.

Press ▲▼◀▶ to set the position.

Positions can be moved to the diagonal directions using the joystick.

- You can also move the position by dragging the histogram on the recording screen.
- A histogram is a graph that displays brightness along the horizontal axis, and the number of pixels at each brightness level on the vertical axis.
By looking at the distribution of the graph, you can determine the current exposure.



(A) ← → (B)

(A) Dark

(B) Bright

- When the recorded image and the histogram do not match each other under the following conditions, the histogram is displayed in orange:
 - During exposure compensation
 - When the flash fires
 - When the standard exposure is not achieved, such as in low light situations.
- When the following functions are being used, the [Histogram] is not available:
 - [WFM/Vector Scope]
 - Video recording when [Proxy Recording] is set to [ON]
- The histogram is an approximation in the recording mode.



[Photo Grid Line]

[] / [] / [] / ▶[OFF]

Sets the grid line pattern to be displayed on the recording screen.

When using [], you can press ▲▼◀▶ to set the position.

Positions can be moved to the diagonal directions using the joystick.

- When using [], you can also drag [] on the grid lines on the recording screen to move the position.

[Live View Boost]

[MODE1] / [MODE2] / ▶[OFF]

[SET]	[P/A/S/M] / ▶[M]
-------	------------------



Displays the screen brighter to make it easier to check subjects and compositions even in low-light environment.

[MODE1]: Setting for low brightness, with priority given to a soft display.



[MODE2]: Setting for high brightness, with priority given to image visibility.

- You can change the recording mode in which [Live View Boost] works by using [SET].
- This mode does not affect recorded images.
- Noise may be more noticeable in the screen than in the recorded image.
- This function does not work in the following cases:
 - When adjusting the exposure (when the shutter button is pressed halfway, for example)
 - When recording a video
 - When using [Filter Settings]
 - When displaying the shutter speed effect of [Constant Preview]

[Night Mode]

[Monitor]	[ON] / ▶[OFF]
[LVF]	[ON] / ▶[OFF]
<p>Displays the monitor and viewfinder in red. In dark environments, this reduces brightness of the screen that can make the surroundings difficult to see. You can also set the luminance of the red display.</p> <ol style="list-style-type: none"> 1 Press ▲▼◀▶ to select [ON] on the monitor or viewfinder (LVF). 2 Press [DISP.] to display the brightness adjustment screen. <ul style="list-style-type: none"> • Display the monitor to adjust the monitor, and display the viewfinder to adjust the viewfinder. 3 Press ◀▶ to adjust luminance and then press  or . <ul style="list-style-type: none"> • This effect is not applied to images output via HDMI. 	

[LVF/Monitor Disp. Set]

[LVF Disp. Set]	
[Monitor Disp. Set]	

Selects whether to show the live view without covering the information display, or to display over the entire screen.

: Scales down images slightly so you can better review the composition of the images.

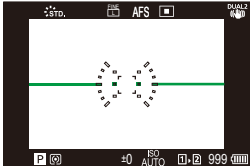

: Scales images to fill the entire screen so you can see their details.

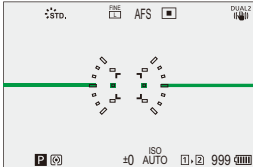

- You can assign the function that switches the currently displayed monitor or viewfinder display style to an Fn button. (→ [\[LVF/Monitor Disp. Set\]: 607](#))

[Horizontal Image Flip(Monitor)]	▶[AUTO] / [ON] / [OFF]
[Vertical Image Flip(Monitor)]	▶[AUTO] / [ON] / [OFF]
<p>You can set whether the screen flips or not depending on the facing or angle of the monitor during recording.</p> <p>[Horizontal Image Flip(Monitor)] [AUTO]: The screen automatically flips horizontally according to the angle to which the monitor is opened or closed. [ON]: The screen is flipped horizontally all the time. [OFF]: Screen is not flipped.</p> <p>[Vertical Image Flip(Monitor)] [AUTO]: The screen automatically flips vertically according to the angle to which the monitor is rotated. [ON]: The screen is flipped vertically all the time. [OFF]: Screen is not flipped.</p> <ul style="list-style-type: none">• The settings for this function are not reflected in the playback screen.	

[Expo.Meter]

[ON] / ▶[OFF]

This displays the exposure meter.

SS	125	60	30	15	8
F	2.8	4.0	5.6	8.0	11

 30 F5.6

- Set to [ON] to display the exposure meter when performing Program Shift, setting aperture, and setting shutter speed.
- If no operations are performed for a certain period of time, the exposure meter disappears.

[Focal Length]

▶[ON] / [OFF]

Displays the focal length on the recording screen during zoom control.

[Blinking Highlights]





[ON] / ▶[OFF]

Overexposed areas appear blinking in black and white during Auto Review or playback.



- The display without the highlights is added to the display shown when [DISP.] is pressed in the playback screen.
Use this to delete the highlight display. (→ [Playback Screen: 96](#))

[Sheer Overlay]

[ON] / ▶[OFF]	
[SET]	[Transparency]
	[Image Select]
	[Reset at Power Off]
	[Disp. Image (shutter-press)]
<p>A picture that has been recorded or an image extracted from a video is overlaid on the recording screen.</p> <ol style="list-style-type: none"> Use [Image Select] and select a picture or video to display. <ul style="list-style-type: none"> Press ◀▶ to select a picture or video and then press  or  to confirm. (When a video is selected) Pause playback at the position you wish to extract a picture. <ul style="list-style-type: none"> Press ▲ to pause playback. To fine-adjust the position, press ◀▶ (rewind frame-by-frame or forward frame-by-frame). (When a video is selected) Set a picture. <ul style="list-style-type: none"> Press  or . <ul style="list-style-type: none"> If you set [Disp. Image (shutter-press)] to [OFF], [Sheer Overlay] is canceled while the shutter button is being pressed halfway or pressed fully. The picture extracted from video is saved. When the following functions are being used, [Sheer Overlay] is not available: <ul style="list-style-type: none"> – Video recording – [Stop Motion Animation] – [Frame.io Connection] – [Auto Transfer] 	

[I.S. Status Scope]

[ON] / ▶[OFF]

Displays a reference point (C) on the recording screen in order to let you check for camera shake.

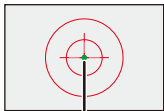

(C)

- [I.S. Status Scope] does not work in the following cases:
 - When [Operation Mode] in [Image Stabilizer] is set to [OFF]
 - When the O.I.S. switch on the lens is [OFF]
- When the following functions are being used, [I.S. Status Scope] is not available:
 - Video recording
 - High Resolution mode (when [Handheld High-Res] is set to [OFF])

[Level Gauge]

▶[ON] / [OFF]

Displays the level gauge which is useful in correcting camera tilt.

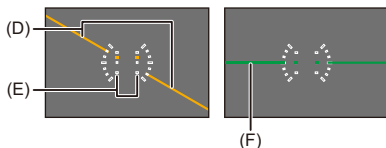

(D) Horizontal

(E) Vertical

(F) Green (no tilt)

- Even after correcting the tilt, there may still be an error of approx. $\pm 1^\circ$.
- When the camera is tilted significantly upwards or downwards, the level gauge may not be displayed correctly.
- You can adjust the level gauge and reset the adjusted values in [Level Gauge Adjust.] in the [Setup] ([Monitor / Display]) menu. (→[Level Gauge Adjust.]: 682)

[Luminance Spot Meter]

[ON] / ▶[OFF]

Specify any spot on the subject to measure the luminance over a small area.

(→ [Luminance Spot Meter]: 456)
--

[Framing Outline]

[ON] / ▶[OFF]

Displays the outline for the live view.

[Show/Hide Monitor Layout]

[Control Panel]	▶[ON] / [OFF]
-----------------	---------------

[Black Screen]	▶[ON] / [OFF]
----------------	---------------

Displays the control panel and black screen when switching between displays using [DISP.] button. (→ Recording Screen: 94)

[Custom] menu ([Monitor / Display (Video)])

▶: Default settings

[Log View Assist]

[LUT Select(V-Log)]

[LUT Select(ARRI LogC3)]

[LUT View Assist (Monitor)]

[ON] / ▶[OFF]

[LUT View Assist (HDMI)]

[ON] / ▶[OFF]

You can show images with LUT file applied on the monitor/viewfinder, or output them via HDMI.

(→[Log View Assist]: 490)

- [LUT Select(ARRI LogC3)] can be used only when you have used the Upgrade Software Key (DMW-SFU3A: optional) and enabled the function with [Activate].

(→[Activate]: 692)

[HLG View Assist]

[Monitor]

[MODE1] / ▶[MODE2] / [OFF]

[HDMI]

▶[AUTO] / [MODE1] / [MODE2] / [OFF]

At recording or playback of HLG video, this displays images with converted color gamut and brightness on the camera monitor/viewfinder, or outputs these over HDMI.

(→[HLG View Assist]: 495)

[Anamorphic Desqueeze Display]

$2.0\times$ / $1.8\times$ / $1.5\times$ / $1.33\times$ / $1.30\times$ / ▶[OFF]

This displays the desqueezed images suited to the magnification of the anamorphic lens on this camera.

(→[Anamorphic Desqueeze Display]: 498)

[Monochrome Live View]

[ON] / ▶[OFF]

You can display the recording screen in black and white.

- If you use the HDMI output during recording, the output image will not be displayed in black and white.
- [Monochrome Live View] is not available when [Night Mode] is used.

[Center Marker]

[-+]/[-;-]/[+]/[-;-]/▶[OFF]

The center of the recording screen will be displayed as [+].

The shape of the marker can be changed.

[Safety Zone Marker]

[□]/[□]/▶[OFF]

[SET]

[Size]

[95%]

▶[90%]

[80%]

This displays the safety zone, which shows a guide to the area that would be shown on a household TV, on the recording screen.

[Frame Marker]

[ON] / ▶[OFF]	
[SET]	[Frame Aspect]
	[Frame Color]
	[Frame Mask]
<p>A frame with the set aspect ratio is displayed on the recording screen. [Frame Aspect] can also be customized. (→[Frame Marker]: 460)</p>	

[Zebra Pattern]

[ZEBRA1] / [ZEBRA2] / [ZEBRA1+2] / ▶[OFF]	
[SET]	[Zebra 1]
	[Zebra 2]
<p>Parts that are brighter than the base value are displayed with stripes. (→[Zebra Pattern]: 458)</p>	

[WFM/Vector Scope]

[WAVE] / [VECTOR] / ▶[OFF]
<p>This displays the waveform monitor or the vector scope on the recording screen. (→[WFM/Vector Scope]: 452)</p>

[Color Bars]

[SMPTE] / [EBU] / [ARIB]

The color bars are displayed on the recording screen.

(→ [Color Bars/Test Tone: 462](#))

[Video-Priority Display]

[ON] / ▶[OFF]

When in [iA]/[P]/[A]/[S]/[M] modes, switch the recording screen display and the control panel to suit video recording, as with the [PM] mode.

The playback screen also switches to a display that prioritizes video.

- When set to a setting where video recording is not available, [Video-Priority Display] is fixed to [OFF].
- [Video-Priority Display] works only during video recording when using the following functions:
 - [Time Lapse Shot]
 - [Stop Motion Animation]

[Red REC Frame Indicator]

[ON] / ▶[OFF]

A red frame is displayed on the recording screen that indicates that video is being recorded.

[Streaming Blue Frame Indicator]

[ON] / ▶[OFF]

Displays a blue frame on the screen during streaming.

[Custom] menu ([IN/OUT])

▶: Default settings

[HDMI Rec Output]

[Info Display] (→ Outputting the Camera Information Display via HDMI: 528)	[ON] / ▶[OFF]
[Down Convert] (→ HDMI Output Image Quality: 519)	▶[AUTO] / [C4K/4K] / [1080p] / [1080i] / [OFF]
[HDMI Recording Control] (→ Outputting Control Information to an External Recorder: 529)	[ON] / ▶[OFF]
[Sound Output (HDMI)] (→ Outputting Audio via HDMI: 529)	▶[ON] / [OFF]
[Enlarged Live Display] (→ Outputting the Enlarged Live Display (Video) via HDMI: 530)	[MODE1] / [MODE2] / ▶[OFF]
[4K/120p Output] / [4K/100p Output] (→ Outputting as 4K/120p (4K/100p) via HDMI: 531)	[ON] / ▶[OFF]
[4K/120p Power Save Live View] / [4K/100p Power Save Live View] (→ [4K/120p Power Save Live View] ([4K/100p Power Save Live View]): 532)	[ON] / ▶[OFF]
Sets HDMI output during recording.	

[Fan Mode]

[AUTO1] / ▶[AUTO2] / [FAST] / [NORMAL] / [SLOW] / [OFF]

Sets fan operation.

[AUTO1]: The camera switches [SLOW]/[NORMAL] automatically according to the temperature of the camera. This setting prioritizes controlling rises in temperature in the camera.

[AUTO2]: The camera switches [OFF]/[SLOW]/[NORMAL] automatically according to the temperature of the camera.

[FAST]: The fan operates constantly at fast speed.

[NORMAL]: The fan operates constantly at a standard speed.

[SLOW]: The fan operates constantly at low speed.

[OFF]: The fan does not operate.

- [OFF] can be set when in [iA]/[P]/[A]/[S]/[M] mode.
- When the following functions are being used, [SLOW] is not available.
 - When the following functions are used while set to [SLOW], the setting switches to [AUTO1]:
 - [Rec Quality] exceeding a resolution of C4K
 - [Rec Quality] with a high frame rate video exceeding a recording frame rate of 60.00p
 - [Variable Frame Rate] exceeding a frame rate of 60 fps

[Tally Lamp]

[Front Tally Lamp]

▶[H] / [L] / [OFF]

[Rear Tally Lamp]

[H] / ▶[L] / [OFF]

Sets how the tally lamps turn on while recording video and their brightness.

[Custom] menu ([Lens / Others])

▶: Default settings

[Lens Focus Resume]

[ON] / ▶[OFF]

The camera saves the focus position when you turn it off.
When using an interchangeable lens compatible with power zoom, the zoom position is also saved.

[Power Zoom Lens]

[Step Zoom]

[ON] / ▶[OFF]

[Zoom Speed(Photo)]

[H] / ▶[M] / [L] / [SL]

[Zoom Speed(Video)]

[Zoom Ring]

▶[ON] / [OFF]

This sets the zoom operation when using a lens that supports power zoom (motorized zoom).

(→ [\[Power Zoom Lens\]: 232](#))

[Lens Fn Button Setting]

▶[Focus Stop] / [AF Mode] / [AF Detection Setting] / [Detecting Subject] / [Focus Ring Lock] / [AE LOCK] / [AF LOCK] / [AF/AE LOCK] / [AF-ON] / [AF-ON : Near Shift] / [AF-ON : Far Shift] / [AF-Point Scope] / [Focus Area Set] / [Enlarged Live Display(Video)] / [Image Stabilizer] / [Preview] / [Preview Aperture Effect] / [No Setting] / [Off (Disable Press and Hold)] / [Restore to Default]

Register a function to the focus button of an interchangeable lens.

- When [Focus Stop] is set, focus is fixed while the focus button is being pressed.

[Aperture Ring Increment]

[SMOOTH] / ▶[1/3EV]

Stops for setting the aperture value with the aperture ring can be changed.

[SMOOTH]: You can finely adjust the aperture value.

[1/3EV]: You can set the aperture value at 1/3 EV stops.

- This can be used when a lens compatible with a clickless aperture ring (H-X1025/H-X2550: optional) is attached. (As of May 2024)
- When taking pictures, this setting will take effect if the aperture ring is set to a position other than [A].
- If the position of the aperture ring is set to [A], the aperture value set by the camera will take effect and can be adjusted like with [1/3EV].
- During video recording, fine adjustments can be made like with [SMOOTH].
- When [SMOOTH] is set, fractions of aperture values are not displayed on the screen.

[Focus Ring Control]

▶[NON-LINEAR] / [LINEAR]	
[SET]	[90°] to [1080°] (▶[300°]) / [Maximum]
<p>Sets the amount of movement for focusing using the focus ring. (When using supported lenses)</p> <p>[NON-LINEAR]: Focus responds by accelerating according to rotation speed of the focus ring.</p> <p>[LINEAR]: Focus responds at a constant amount according to the rotational angle of the focus ring.</p> <ul style="list-style-type: none"> • When using lenses equipped with focus clutch mechanisms, set the lens to AF and the camera to MF. <p>[SET]: Sets the rotational angle of the focus ring for when [LINEAR] is selected.</p> <ul style="list-style-type: none"> • Angles that cannot be set with the attached lens are not displayed. • For information on lenses that support focus ring control, refer to the following support site: https://panasonic.jp/support/global/cs/dsc/connect/index.html (English only) 	

[AF Micro Adjustment]

[ALL] / [ADJUST BY LENS] / ▶[OFF]
<p>You can make fine adjustments to the focus point when focusing with phase detection AF.</p> <p>(➔[AF Micro Adjustment]: 185)</p>

[Lens Information]

[Lens1] to [Lens12] (▶[Lens1])

When using a lens that does not have a communication function with the camera, register the lens information in the camera.

- This is linked with [Lens Information] in [Image Stabilizer] under the [Photo] ([Others (Photo)]) menu. (→[Lens Information]: 300)

[Lens Info. Confirmation]

▶[ON] / [OFF]

When you have attached a lens that does not have a communication function with this camera, a message asking for confirmation of the lens information is displayed when you turn on the camera.

[Vertical Position Info (Video)]

▶[ON] / [OFF]

You can set whether or not to record the camera's vertical orientation information during video recording.

[ON]: Records vertical orientation information. Videos recorded with the camera held vertically will be automatically played back vertically on the PC, smartphone, etc. during playback.

[OFF]: Does not record vertical orientation information.

- On the playback screen of the camera, only the thumbnail display is played in vertical orientation.

[Setup] Menu

- [Setup] menu ([Card/File]): 669
- [Setup] menu ([Monitor / Display]): 678
- [Setup] menu ([IN/OUT]): 683
- [Setup] menu ([Setting]): 690
- [Setup] menu ([Others]): 693

[Setup] menu ([Card/File])

▶: Default settings

[Card Format]

[Card Slot 1(CFexpress)] / [Card Slot 2(SD)]

Formats the card (initialization).

Format the cards with the camera before use.

Low level formatting of CFexpress cards

When formatting CFexpress cards, you can select whether to perform a low level format.

If the writing speed of the card has started to drop, we recommend performing a low level format.

- 1 Select [Card Slot 1(CFexpress)].
- 2 Press [DISP.] and put a check mark next to [Low Level Format].
- 3 Select [Yes].

• **When a card is formatted, all of the data stored in the card is erased and cannot be restored.**

Save a backup of necessary data before formatting the card.

- Do not turn off the camera or perform another operation during formatting.
- Take care not to turn off the camera while formatting is in progress.
- If the card has been formatted with a PC or other device, format it again with the camera.
- You can format the card while keeping the camera settings information stored on the card. (→[Save/Restore Camera Setting]: 691)
- When formatting, depending on the [Video File Name] setting, the volume label of the card may be changed. (→[Video File Name]: 672)
 - When it is [Same As Photo(DCF Standard)]: “LUMIX”
 - When it is [CINE Style]: The volume label set in [CINE Style File Setting]

[Double Card Slot Function]

[Recording Method]

▶ [📷] / [📷] / [📷]

This sets the way recording to the card slots 1 and 2 is performed.

 **[Relay Rec]**: Selects the priority of card slots for recording.

[Destination Card Slot]: [1 → 2] / [2 → 1]

Relays recording to the card in the other card slot after the first card runs out of free space.

- You can assign the function that changes the card which is prioritized for recording to an Fn button. (→ [\[Destination Card Slot\]: 608](#))

 **[Backup Rec]**: Records the same images to both cards simultaneously.

 **[Allocation Rec]**: Allows you to specify the card slot to be used for recording for different image formats.

[JPEG Destination]/[RAW Destination]/[Video Destination]

- [Double Card Slot Function] does not work when using the following functions:
 - [Rec. File Format] or [Rec Quality] that does not allow recording to SD cards
 - [Proxy Recording]

Notes about relay recording

- The following video cannot be continued to be recorded on another card:
 - [Loop Recording (video)]

Notes about Backup Recording

- We recommend using cards with the same capacity.
If the card Speed Class or capacity is insufficient when video recording, recording to both cards stops.
- Backup recording is not available with the following video. They can only be recorded on a single card:
 - [Loop Recording (video)]
- When using the following combinations of cards, backup recording for videos is not available:
 - SD/SDHC memory cards and CFexpress cards

[USB-SSD]

[ON] / ▶[OFF]

The commercially available external SSD that is connected to the USB port can be used when this is set to [ON]. (→ [Using an External SSD \(Commercially Available\): 541](#))

[Video File Name]**▶[Same As Photo(DCF Standard)] / [CINE Style]**

The folder name and file name used when saving video to cards are switched to CINE Style.

[Same As Photo(DCF Standard)]: Video files are saved using the same naming convention as pictures. The storage destination is within the DCIM folder.

[CINE Style]: The naming convention for video files is switched to CINE Style. The storage destination is within the PRIVATE folder.

Naming conventions when set to [CINE Style]**Folder name**

001A A P A M

(1) (2)(3)(4)(5)(6)

(1) Folder number (3 numeric characters, 001 to 999)

(2) Fixed to "A"

(3) Frame rate

A: 59.94p / B: 50.00p / C: 29.97p/59.94i / D: 25.00p/50.00i / E: 24.00p / F:
23.98p / G: 48.00p / H: 47.95p / J: 239.76p / K: 200.00p / L: 120.00p / M:
119.88p / N: 100.00p

(4) Video format

J: Interlace recording (MOV, LPCM) / P: Progressive recording (MP4, AAC) /
Q: Progressive recording (MOV, LPCM) / Y: Progressive recording (Apple
ProRes, LPCM)

(5) Fixed to "A"

(6) Recording setting

During relay recording/allocation recording:

M: Card slot 1 / M: Card slot 2

During backup recording:

M: Card slot 1 / T: Card slot 2

File name

A001C001_221201_E125.MOV

┌─┐┌─┐┌─┐┌─┐┌─┐
└─┘└─┘└─┘└─┘└─┘
(7) (8) (9) (10) (11) (12)

- (7) Camera index (1 alphabetic character, A to Z)
- (8) Card number (3 numeric characters, 001 to 999)
- (9) Clip number (4 alphanumeric characters, C001 to C999)
- (10) Year, month, day (YYMMDD)
- (11) Hash value (4 alphanumeric characters)
- (12) Extension

- Use a card with a capacity of 48 GB or greater to set to [CINE Style].
- Up to 999 files can be stored in each folder.
- Clip numbers are assigned sequentially from C001 to C999 in the order of recording.

If you change the storage folder, a number continuing on from the last clip number will be assigned.

- In the following cases, a new folder with an incremented folder number will be created automatically when the next file is saved:
 - The clip number reaches 999
 - Any of the settings (3), (4), or (6) are changed
- New folders cannot be created when the folder number reaches 999.
We recommend backing up your data and formatting the card.
- The following files are saved in the DCIM folder even if you select [CINE Style]:
 - Video created from [Time Lapse Shot]/[Stop Motion Animation]
 - Pictures extracted from video

[CINE Style File Setting]

▶[Camera Index] / [Next Card Number]

When [Video File Name] is set to [CINE Style], volume labels can be set for cards. The volume label will be the [Camera Index]+[Next Card Number] set by the following.

[Camera Index]: The camera index of the volume label can be set in the range between A and Z.

[Next Card Number]: The card number of the volume label can be set in the range between 001 and 999.

- The volume label changes at the following times:
 - When a card is formatted
 - When a video is recorded
- How to enter characters (→ [Entering Characters: 108](#))

[Folder / File Settings]

[Select Folder] / [Create a New Folder] / [File Name Setting]

Set the folder and file name where to save the images.

Folder name

100ABCDE



- (1) Folder number (3 numeric characters, 100 to 999)
 (2) 5-character user-defined segment

File name

PABC0001.JPG



- (3) Color space ([P]: sRGB, [_]: AdobeRGB)
 (4) 3-character user-defined segment
 (5) File number (4 numeric characters, 0001 to 9999)
 (6) Extension

[Select Folder]: Selects a folder for storing images.

- When [Double Card Slot Function] is set to [Allocation Rec], [Select Folder (Slot 1)] and [Select Folder (Slot 2)] will be displayed.

[Create a New Folder]: Creates a new folder with an incremented folder number.

- If there are no recordable folders in the card, a screen for resetting the folder number is displayed.

[OK]:

Increments the folder number without changing the 5-character user-defined segment ((2) above).

[Change]:

Changes the 5-character user-defined segment ((2) above). This will also increment the folder number.

[File Name Setting]

[Folder Number Link]:

Uses the 3-character user-defined segment ((4) above) to set the folder number ((1) above).

[User Setting]:

Changes the 3-character user-defined segment ((4) above).

- Follow the steps on “[Entering Characters](#)” when the character entry screen is displayed. (→ [Entering Characters: 108](#))

Available characters: alphabetic characters (upper-case), numerals, [_]

- Each folder can store up to 1000 files.
- File numbers are assigned sequentially from 0001 to 9999 in the order of recording.

If you change the storage folder, a number continuing on from the last file number will be assigned.

- In the following cases, a new folder with an incremented folder number will be created automatically when the next file is saved:
 - The number of files in the current folder reaches 1000.
 - The file number reaches 9999.
- New folders cannot be created when there are folders numbered from 100 all the way up to 999.

We recommend backing up your data and formatting the card.

- [Select Folder] is not available when [Backup Rec] in [Double Card Slot Function] is being used.

[File Number Reset]

[Card Slot 1(CFexpress)] / [Card Slot 2(SD)]

Refresh the folder number within the DCIM folder and reset the file number to 0001.

- When the folder number reaches 999, the file number cannot be reset.
We recommend backing up your data and formatting the card.
- **To reset the folder number to 100:**
 - 1 Perform [Card Format] to format the card. (→[\[Card Format\]: 669](#))
 - 2 Perform [File Number Reset] to reset the file number.
 - 3 Select [Yes] on the folder number reset screen.
- To reset the folder number and file number inside the PRIVATE folder to 001, format the card. (→[\[Card Format\]: 669](#))

[Copyright Information]

[Artist]

[ON] / ▶[OFF] / [SET]

[Copyright Holder]

[ON] / ▶[OFF] / [SET]

[Display Copyright Info.]

Records the names of the artist and the copyright holder in the image Exif data.

- You can register names from [SET] in [Artist] and [Copyright Holder].
How to enter characters (→[Entering Characters: 108](#))
- Up to 63 characters may be entered.
- You can confirm registered copyright information in [Display Copyright Info.].

[Setup] menu ([Monitor / Display])

▶: Default settings

[Power Save Mode]

[Sleep Mode]	[10MIN.] / [5MIN.] / [2MIN.] / ▶[1MIN.] / [OFF]
[Sleep Mode(Wi-Fi)]	▶[ON] / [OFF]
[Auto LVF/Monitor Off]	[5MIN.] / [2MIN.] / ▶[1MIN.] / [OFF]
[Power Save LVF Shooting]	[Time to Sleep]
	[Method of Activation]

This is a function to automatically turn the camera to sleep (power save) status or turn off the viewfinder/monitor if no operation is performed for a set time.

(→[Power Save Mode]: 60)

[Thermal Management]

[Recording Max Temperature]

[HIGH] / ▶[STANDARD]

This sets the temperature during video recording at which the camera automatically stops recording.

When set to [HIGH], recording continues even if the camera temperature rises.

[Recording Max Temperature]

[HIGH]: Sets the temperature at which recording is stopped due to the camera temperature rising to a higher temperature.

- You can record for a longer time, but the camera body will become hot.
Use a tripod, etc., because recording with a handheld camera for long periods can cause low temperature burns.

[STANDARD]: Recording stops when the camera temperature rises.

- Set to [STANDARD] when recording with a handheld camera.

[Monitor Frame Rate]

[30fps] / ▶[60fps]

Sets the display speed for live view on the monitor when recording pictures.

[30fps]: Reduces the power consumption for a longer operating time.

[60fps]: Enables smooth display of movements.

- When the following function is being used, [Monitor Frame Rate] is not available:
 - HDMI output

[LVF Frame Rate]

▶[60fps] / [120fps]

Sets the display speed for live view on the viewfinder when recording pictures.

[60fps]: Reduces the power consumption for a longer operating time.

[120fps]: Enables smooth display of movements.

- [LVF120] is displayed on the viewfinder when it is displayed at [120fps].
- When set to [120fps], the images in the viewfinder will not be as smooth as with [60fps], but there will be no change to the images recorded.
- When the following functions are being used, [LVF Frame Rate] is not available:
 - HDMI output
 - While connected to Wi-Fi

[Monitor Settings]/[Viewfinder]

[Brightness] / [Contrast] / [Saturation] / [Red Tint] / [Blue Tint]

This adjusts the brightness, coloring, and red or blue tints of the monitor/viewfinder.

1 Press ▲▼ to select the setting item, and press ◀▶ to adjust.

2 Press  or  to confirm the setting.

- It will adjust the monitor when the monitor is in use, and the viewfinder when the viewfinder is in use.

[Monitor Backlight]/[LVF Luminance]

▶[AUTO] / [-3] to [+3]

Adjusts monitor/viewfinder luminance.



[AUTO]: The brightness is adjusted automatically depending on how bright it is around the camera.

- Adjusts the monitor luminance when displaying the monitor, and the viewfinder luminance when displaying the viewfinder.
- When either [AUTO] is set, or the adjusted value is set to positive side, the usage period will shorten.
- When [Night Mode] is being used, [Monitor Backlight]/[LVF Luminance] are not available.

[Eye Sensor]

[Sensitivity]	▶[HIGH] / [LOW]
This will set the sensitivity of the eye sensor.	
[LVF/Monitor Switch]	▶[LVF/MON AUTO] (automatic viewfinder/monitor switching) / [LVF] (viewfinder) / [MON] (monitor)
This will set the method for switching between the viewfinder and monitor.	
<ul style="list-style-type: none"> • If you press [LVF] to switch the display, the [LVF/Monitor Switch] setting will also switch. 	

[Level Gauge Adjust.]

[Adjust.]
Hold the camera in a horizontal position, and press  or  . The level gauge will be adjusted.
[Level Gauge Value Reset]
Restores the default level gauge setting.

[Setup] menu ([IN/OUT])

▶: Default settings

[Beep]

[Beep Volume]	[] (High) / ▶[] (Low) / [] (Off)
[AF Beep Volume]	[] (High) / ▶[] (Low) / [] (Off)
[AF Beep Tone]	▶[] (Pattern 1) / [] (Pattern 2) / [] (Pattern 3)
[E-Shutter Vol]	[] (High) / ▶[] (Low) / [] (Off)
[E-Shutter Tone]	▶[] (Pattern 1) / [] (Pattern 2) / [] (Pattern 3)
Sets the beep sounds, AF beep, and electronic shutter sounds.	

[Headphone Volume]

[0] to [LEVEL15] (▶[LEVEL3])

Adjusts the volume when headphones are connected.

(→ [Adjusting the Headphone Volume: 434](#))

- This functions in tandem with [Headphone Volume] in the [Video] ([Audio]) menu.

[Sound Monitoring Channel(Play)]

▶[COMBINED WITH REC] / [CH1/CH2] / [CH3/CH4] / [CH1+CH2/CH3+CH4] / [CH1] / [CH2] / [CH3] / [CH4] / [CH1+CH2] / [CH3+CH4] / [CH1+CH2+CH3+CH4]

During video playback, this selects the audio channel output to the speaker on the camera or the headphones.

For information about output audio (→[Sound Monitoring Channel]: 435)

[COMBINED WITH REC]: Outputs audio with the same settings as [Sound Monitoring Channel] in the [Video] ([Audio]) menu.

- You cannot change settings during video playback.
- The L channel and R channel are mixed for audio output from the camera's speaker.

[Streaming]

[Streaming Function] (→Streaming Settings: 810)	[ON] / ▶[OFF]
[Streaming Method] (→Streaming Settings: 810)	▶[Direct] / [Via PC Software]
[Connection Method] (→Streaming Settings: 810)	▶[Wi-Fi] ^{*1} / [USB Tethering] ^{*1} / [LAN] ^{*2}
[Streaming Setup] (→Streaming Settings: 810)	[Streaming Quality]
	[RTSP Port] ^{*2}
	[Streaming Address] ^{*1}
	[Save/Load Streaming Address] ^{*1}
	[Wi-Fi Connection Setting] ^{*3}

*1 Displayed when [Streaming Method] is set to [Direct].

*2 Displayed when [Streaming Method] is set to [Via PC Software].

*3 Displayed when [Connection Method] is set to [Wi-Fi].

[LAN / Wi-Fi®]

[Wi-Fi Function] (→ [Connecting to a Smartphone \(\[Wi-Fi connection\]\): 741](#), [Wi-Fi Connections: 772](#))

[LAN / Wi-Fi Setup] (→ [\[LAN / Wi-Fi Setup\] Menu: 784](#))

[Bluetooth®]

[Bluetooth Function] (→ [Connecting to a Smartphone \(Bluetooth Connection\): 734](#))

[Pairing]

[Add New Device]

[Delete]

[Auto Transfer] (→ [\[Auto Transfer\]: 759](#))

[Location Logging] (→ [\[Location Logging\]: 762](#))

[LUMIX Sync Settings]

[Send Image (Smartphone)] (→ [Using the menu to transfer easily: 748](#))

[Remote Wakeup] (→ [\[Remote Wakeup\]: 764](#))

[Returning from Sleep Mode] (→ [Shortening the Return Time from \[Sleep Mode\]: 756](#))

[Auto Clock Set] (→ [\[Auto Clock Set\]: 766](#))







[Wi-Fi network settings]

[Wi-Fi network settings]: Registers the Wi-Fi access point. Wireless access points used to connect the camera to Wi-Fi networks will be registered automatically.

[Frame.io]

[Frame.io Connection] (→ Connecting with Frame.io: 788)	
[Send Images to Frame.io] (→ [Send Images to Frame.io]: 793)	
[Connection Setup]	[Connection Method]
	[Wi-Fi Connection Setting]
[Upload Setup]	[Auto Upload to Queue]
	[Upload File Format]
	[Clear Upload History]
	[Upload Status]
	[Clear Upload Queue]

[USB]

[USB Mode]	▶[] [Select on connection] / [] [PC(Storage)] / [] [PC(Tether)]
<p>This sets the communication method to be used when the USB connection cable is connected.</p> <p>[] [Select on connection]: Select this setting to select the USB communication system when connecting to another device. (→USB port: 822)</p> <p>[] [PC(Storage)]: Select this setting to export images to a connected PC. (→Importing Images to a PC: 827)</p> <p>[] [PC(Tether)]: Select this setting to control the camera from a PC installed with “LUMIX Tether”. (→Tethered Recording: 833)</p>	
[USB Power Supply]	▶[ON] / [OFF]
<p>Provides power from the USB connection cable.</p> <ul style="list-style-type: none"> • Even if this item is set to [OFF], power will be supplied when the AC adaptor is connected. 	
[Tether(USB ethernet adaptor)]	[ON] / ▶[OFF]
<p>This enables connection to “LUMIX Tether” with a wired LAN connection.</p>	

[HDMI Connection]

[Output Resolution(Playback)]	▶[AUTO] / [C4K/120p] / [C4K/100p] / [C4K/60p] / [C4K/50p] / [C4K/30p] / [C4K/25p] / [C4K/24p] / [4K/120p] / [4K/100p] / [4K/60p] / [4K/50p] / [4K/30p] / [4K/25p] / [4K/24p] / [1080/120p] / [1080/100p] / [1080p] / [1080i] / [720p] / [576p] / [480p]
<p>Sets the HDMI output resolution for playback.</p> <p>[AUTO]: Outputs with a resolution suited to the connected external device. When playing back pictures, output is at a maximum resolution of 8K.</p> <ul style="list-style-type: none"> • The items you can select depend on the [System Frequency] setting. • If no image appears on the external device with [AUTO], switch to a setting other than [AUTO] to set a format supported by your external device. (Please also refer to the operating instructions for the external device.) • It may not be possible to play back video, depending on the external device connected. 	
[LUT View Assist (HDMI)]	[ON] / ▶[OFF]
<p>Images with LUT (Look-Up Table) file applied are output when you play back videos recorded with [Photo Style] set to [V-Log]/[ARRI LogC3].</p> <ul style="list-style-type: none"> • This is linked with [LUT View Assist (HDMI)] in [Log View Assist] under the [Custom] ([Monitor / Display (Video)]) menu. (→[Log View Assist]: 490) 	

[HLG View Assist (HDMI)]	▶[AUTO] / [MODE1] / [MODE2] / [OFF]
<p>At recording or playback of HLG video, this converts their color gamut and brightness for display.</p> <ul style="list-style-type: none"> • This is linked with [HDMI] in [HLG View Assist] under the [Custom] ([Monitor / Display (Video)]) menu. (→[HLG View Assist]: 495) 	
[VIERA Link (CEC)]	[ON] / ▶[OFF]
<p>You can use the device remote control to operate the camera when it is connected to a VIERA Link compatible device using an HDMI cable. (→Using VIERA Link: 825)</p>	
[Background Color(Playback)]	[■] / ▶[■]
<p>Sets the color of the bands displayed on the top and bottom or the left and right of images output on an external device.</p> <ul style="list-style-type: none"> • We recommend setting to [■] to prevent burn-in on the screen of the output destination. 	
[Photo Luminance Level]	[0-255] / ▶[16-255]
<p>Sets the level of luminance when outputting pictures to external devices.</p>	

[Power/Network Indicator]

▶[ON] / [OFF]
This will turn on the power indicator and network connection light.

[Setup] menu ([Setting])

[Save to Custom Mode]

[C1] / [C2] / [C3] / [C4-1] to [C4-10]

You can register the currently set information of the camera.

(→ [Register in Custom Mode: 623](#))

[Load Custom Mode]

[C1] / [C2] / [C3] / [C4-1] to [C4-10]

Calls up registered Custom mode settings to the selected recording mode and overwrites the current settings with these.

(→ [Calling Up Settings: 626](#))

[Custom Mode Settings]

[Limit No. of Custom Mode]

[Edit Title]

[How to Reload Custom Mode]

[Select Loading Details]

Sets the ease of use of Custom mode.

(→ [Custom Mode Detailed Settings: 624](#))

[Save/Restore Camera Setting]

[Save] / [Load] / [Delete] / [Keep Settings While Format]

Saves the camera's settings information to the card.

Saved settings information can be loaded to the camera, letting you set the same settings on multiple cameras.

[Save]: Saves the camera's settings information to the card.

- If saving new data, then select [New File], and if overwriting an existing file, select that existing file.
- When [New File] is selected, a screen to select the file name to save as is displayed.

[OK]:

Saves using the file name on the screen.

[Change the file name]:

Changes the file name and saves the file.

- Available characters: alphabetic characters (upper-case), numerals, up to 8 characters
- How to enter characters (→ [Entering Characters: 108](#))

[Load]: Loads the settings information on the card and copies it to the camera.

[Delete]: Deletes settings information on the card.

[Keep Settings While Format]: When formatting the card, formats the card while keeping camera settings information stored on the card.

- Only settings information from the same model can be loaded.
- Up to 10 instances of settings information can be saved on one card.
- List of functions for which saving of settings information is possible (→ [List of Default Settings/Custom Saving/Settings Available for Copying: 919](#))

[Reset]

Returns the camera to its default settings.

(→ [\[Reset\]: 107](#))

[Activate]

[Export Serial Code] / [Import Activation Code] / [Activation List]

Using an Upgrade Software Key (DMW-SFU3A: optional) enables usage of extended functions for the camera.

[Export Serial Code]: Exports the device information of the camera to the card.

[Import Activation Code]: Imports the activation code into the camera to enable extended functions.

[Activation List]: Displays extended functions which have been enabled for usage on the camera.

- After activation, even if [Reset] is selected in the [Setup] ([Setting]) menu, re-activation is not required.
- Refer to the Installation guide supplied with the Upgrade Software Key (DMW-SFU3A: optional) for details about activation methods.

[Setup] menu ([Others])



[Clock Set]

Sets the date and time.

(→ [Setting the Clock \(When Turning On for the First Time\): 75](#))

[Time Zone]

Sets the time zone.

Press ◀▶ to select the time zone and then press  or  to confirm.

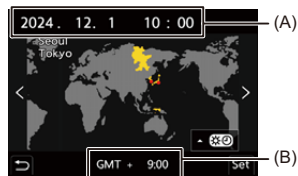

(A) Current time

(B) Time difference from GMT (Greenwich Mean Time)

- If you are using Daylight Savings [], press ▲. (The time will move forward by 1 hour.)

To return to the normal time, press ▲ again.

[System Frequency]

[59.94Hz (NTSC)] / [50.00Hz (PAL)] / [24.00Hz (CINEMA)]

* Default setting specifications vary depending on the country or area where the camera was purchased.

This changes the system frequency of videos that are recorded and played back with the camera.

(→[System Frequency]: 138)

[Pixel Refresh]

This optimizes the image sensor and image processing.

- The image sensor and image processing are optimized when the camera is purchased. Use this function when bright spots that do not exist in the subject get recorded.
- Turn the camera off and on after the pixels are corrected.

[Sensor Cleaning]

Dust reduction to blow off the debris and dust that have affixed to the front of the image sensor is performed.

- You can use this function when the dust is particularly noticeable.
- Turn the camera off and on when finished.

[Language]

This set the language displayed on the screen.

- If you set a different language by mistake, select [] from the menu icons to set the desired language.



[Firmware Version]

[Firmware Update] / [Software info]

You can check the firmware versions of the camera and lens.

In addition, you can update the firmware, and display information about the camera software.

[Firmware Update]: Updates firmware.

- 1 Download the firmware. (→ [Firmware of Your Camera/Lens: 20](#))
- 2 Save the firmware to the root directory of the card (the first folder that appears when you access the card on your PC), and then insert the card into the camera.
- 3 Select [Firmware Update], press  or , and then select [Yes] to update the firmware.

[Software info]: Displays information about the camera software.

- When a supported optional item (XLR Microphone Adaptor, etc.) is attached to the camera, you can also check its firmware version.

[Approved Regulations]

Displays the certification number for radio regulations.

- * Depending on the country or area where the camera was purchased, this is not displayed due to differences in specifications.

[Root Certificate]

[Load] / [Delete] / [Certificate Information]

Registers a root certificate when connecting to the network.

[Load]: Registers a root certificate saved on a card to the camera. (Maximum 6 files)

- Consult the administrator of the service you are connecting to for information on acquiring root certificates.
- Save the certificates you are registering for the first time in the root directory of the card.
- You can register certificates with the file extensions “.pem”, “.cer”, or “.crt”.
- You cannot register those that are not recognized as certificates by OpenSSL commands.

[Delete]: Selects root certificates registered with [Load] and deletes them.



[Certificate Information]: Selects root certificates registered with [Load] and displays their information.

My Menu

- [Registration in My Menu: 698](#)
- [Edit My Menu: 699](#)

Register frequently-used menus in My Menu.

A maximum of 23 items can be registered.



Registered menus can be called up from [] to [].

Registration in My Menu

1 Select [Add].

-  → [] → [] → [Add]

2 Register.

- Select the menu to register and then press  or .

❖ Calling up My Menu

Call up the menus registered in My Menu.

 → [] → []/[]/[] → Registered menus

Edit My Menu

You can reorder the display order of My Menu, and delete unnecessary menus.



[Add]

Selects and registers the menus to be displayed in My Menu.

[Sorting]

Changes the order of My Menu.

Select the menu to change, then set the destination.

[Delete]

Deletes menus that are registered to My Menu.

[Delete Item]: Selects the menu, then deletes.

[Delete All]: Deletes all menus registered in My Menu.

[Display from My Menu]

Displays My Menu first when displaying a menu.

[ON]: Displays My Menu.

[OFF]: Displays the last-used menu.

List of Menu

Camera customization and many function settings are performed with menus on this camera.

This chapter introduces all of the menu items in a list format.



- For information about menu operation methods (→ [Menu Operation Methods: 102](#))
- Refer to the “[Materials](#)” chapter for the following lists:
 - [List of Default Settings/Custom Saving/Settings Available for Copying: 919](#)
 - [List of Functions That Can Be Set in Each Recording Mode: 947](#)

- [\[Photo\] menu: 701](#)
- [\[Video\] menu: 703](#)
- [\[Custom\] menu: 706](#)
- [\[Setup\] menu: 710](#)
- [\[My Menu\]: 713](#)
- [\[Playback\] menu: 714](#)





[Photo] menu

: Menu items common to the [Photo] menu and [Video] menu. Their settings are synchronized.

[Image Quality]

- [Photo Style] (→ [\[Photo Style\]: 342](#)) 
- [Metering Mode] (→ [\[Metering Mode\]: 303](#)) 
- [Aspect Ratio] (→ [\[Aspect Ratio\]: 124](#))
- [Picture Quality] (→ [\[Picture Quality\]: 127](#))
- [Picture Size] (→ [\[Picture Size\]: 125](#))
- [High Resolution Mode Setting] (→ [High Resolution mode: 247](#))
- [Long Exposure NR] (→ [\[Long Exposure NR\]: 287](#))
- [ISO Sensitivity (photo)] (→ [\[ISO Sensitivity \(photo\)\]: 332](#))
- [Synchro Scan(Photo)] (→ [\[Synchro Scan\(Photo\)\]: 288](#))
- [Min. Shutter Speed] (→ [\[Min. Shutter Speed\]: 290](#))
- [i.Dynamic Range] (→ [\[i.Dynamic Range\]: 325](#)) 
- [Vignetting Comp.] (→ [\[Vignetting Comp.\]: 370](#)) 
- [Diffraction Compensation] (→ [\[Diffraction Compensation\]: 371](#)) 
- [Filter Settings] (→ [\[Filter Settings\]: 356](#)) 

[Focus]



- [AF Detection Setting] (→ [Automatic Detection: 192](#)) 
- [Detecting Subject] (→ [Automatic Detection: 192](#)) 
- [AF Custom Setting(Photo)] (→ [\[AF Custom Setting\(Photo\)\]: 178](#))
- [Focus Limiter] (→ [\[Focus Limiter\]: 181](#)) 
- [AF Assist Light] (→ [\[AF Assist Light\]: 183](#)) 
- [Focus Peaking] (→ [\[Focus Peaking\]: 220](#)) 
- [Focus Frame Moving Speed] (→ [\[Focus Frame Moving Speed\]: 184](#))



[Flash]

- [Flash Mode] (→[Flash Mode]: 378)
- [Firing Mode] (→[Firing Mode]/[Manual Flash Adjust.]: 381)
- [Flash Adjust.] (→[Flash Adjust.]: 383)
- [Flash Synchro] (→[Flash Synchro]: 384)
- [Manual Flash Adjust.] (→[Firing Mode]/[Manual Flash Adjust.]: 381)
- [Auto Exposure Comp.] (→[Auto Exposure Comp.]: 385)
- [Wireless] (→Recording Using a Wireless Flash: 386)
- [Wireless Channel] (→Recording Using a Wireless Flash: 386)
- [Wireless FP] (→[Wireless FP]: 392)
- [Communication Light] (→[Communication Light]: 392)
- [Wireless Setup] (→Setting Items ([Wireless Setup]): 390)







[Others (Photo)]

- [Bracketing] (→Bracket Recording: 269)
- [Silent Mode] (→[Silent Mode]: 281) 
- [Crop Zoom(Photo)] (→[Crop Zoom(Photo)]: 224)
- [Image Stabilizer] (→Image Stabilizer: 292) 
- [Burst Shot Setting] (→Taking Burst Pictures: 236)
- [Shutter Type] (→[Shutter Type]: 283)
- [Shutter Delay] (→[Shutter Delay]: 291)
- [Time Lapse/Animation] (→Recording with Time Lapse Shot: 252,
Recording with Stop Motion Animation: 259)
- [Live View Composite] (→[Live View Composite]: 277)
- [Self Timer] (→Recording Using the Self-timer: 265) 

[Video] menu

: Menu items common to the [Photo] menu and [Video] menu. Their settings are synchronized.







[Image Quality]

- [Exposure Mode] (→ [Setting the Exposure for Recording Videos: 396](#))
- [Photo Style] (→ [\[Photo Style\]: 342](#)) 
- [Metering Mode] (→ [\[Metering Mode\]: 303](#)) 
- [ISO Sensitivity (video)] (→ [\[ISO Sensitivity \(video\)\]: 412](#))
- [Synchro Scan(Video)] (→ [\[Synchro Scan\(Video\)\]: 500](#))
- [Flicker Decrease (Video)] (→ [\[Flicker Decrease \(Video\)\]: 449](#))
- [Master Pedestal Level] (→ [\[Master Pedestal Level\]: 409](#))
- [SS/Gain Operation] (→ [\[SS/Gain Operation\]: 450](#))
- [i.Dynamic Range] (→ [\[i.Dynamic Range\]: 325](#)) 
- [Vignetting Comp.] (→ [\[Vignetting Comp.\]: 370](#)) 
- [Diffraction Compensation] (→ [\[Diffraction Compensation\]: 371](#)) 
- [Filter Settings] (→ [\[Filter Settings\]: 356](#)) 

[Image Format]

- [Rec. File Format] (→ [\[Rec. File Format\]: 140](#))
- [Image Area of Video] (→ [\[Image Area of Video\]: 166](#))
- [Rec Quality] (→ [\[Rec Quality\]: 142](#))
- [Rec Quality (My List)] (→ [\[add to list\]: 157](#))
- [Variable Frame Rate] (→ [Variable Frame Rate: 465](#))
- [Proxy Recording Settings] (→ [Proxy Recording: 161](#))
- [Time Code] (→ [Setting the Time Code: 438](#))
- [Luminance Level] (→ [\[Luminance Level\]: 407](#))
- [HDMI RAW Data Output] (→ [Outputting RAW Video Data via HDMI: 535](#))



[Focus]

- [AF Detection Setting] (→ [Automatic Detection: 192](#)) 
- [Detecting Subject] (→ [Automatic Detection: 192](#)) 
- [AF Custom Setting(Video)] (→ [\[AF Custom Setting\(Video\)\]: 404](#))
- [Focus Limiter] (→ [\[Focus Limiter\]: 181](#)) 
- [Continuous AF] (→ [\[Continuous AF\]: 402](#))
- [AF Assist Light] (→ [\[AF Assist Light\]: 183](#)) 
- [Focus Peaking] (→ [\[Focus Peaking\]: 220](#)) 
- [Focus Frame Moving Speed] (→ [\[Focus Frame Moving Speed\]: 184](#))



[Audio]

- [Sound Rec Level Disp.] (→ [\[Sound Rec Level Disp.\]: 414](#))
- [Mute Sound Input] (→ [\[Mute Sound Input\]: 415](#))
- [Sound Rec Gain Level] (→ [\[Sound Rec Gain Level\]: 416](#))
- [Sound Rec Level Adj.] (→ [\[Sound Rec Level Adj.\]: 417](#))
- [Sound Rec Quality] (→ [\[Sound Rec Quality\]: 418](#))
- [Sound Rec Level Limiter] (→ [\[Sound Rec Level Limiter\]: 420](#))
- [Wind Noise Canceller] (→ [\[Wind Noise Canceller\]: 421](#))
- [Wind Cut] (→ [Reduction of Wind Noise: 428](#))
- [Lens Noise Cut] (→ [\[Lens Noise Cut\]: 422](#))
- [Mic Socket] (→ [External Microphones \(Optional\): 424](#))
- [Special Mic.] (→ [Setting the Sound Pickup Range \(DMW-MS2: Optional\): 427](#))
- [4ch Audio Recording] (→ [\[4ch Audio Recording\]: 432](#))
- [XLR Mic Adaptor Setting] (→ [XLR Microphone Adaptor \(Optional\): 429](#))
- [Sound Output] (→ [Switching the Sound Output Method: 434](#))
- [Headphone Volume] (→ [Adjusting the Headphone Volume: 434](#))
- [Sound Monitoring Channel] (→ [\[Sound Monitoring Channel\]: 435](#))

[Others (Video)]

- [Silent Mode] (→[\[Silent Mode\]: 281](#)) 
- [Crop Zoom(Video)] (→[\[Crop Zoom\(Video\)\]: 228](#))
- [Image Stabilizer] (→[Image Stabilizer: 292](#)) 
- [Self Timer Setting] (→[Recording Using the Self-timer: 265](#)) 
- [Focus Transition] (→[\[Focus Transition\]: 473](#))
- [Loop Recording (video)] (→[\[Loop Recording \(video\)\]: 502](#))
- [Segmented File Recording] (→[\[Segmented File Recording\]: 505](#))
- [Live Cropping] (→[\[Live Cropping\]: 478](#))

[Custom] menu

-  [Image Quality] (→ [Custom] menu ([Image Quality]): 628)
- [Photo Style Settings] (→ [Photo Style Settings]: 628)
- [LUT Library] (→ [LUT Library]: 364)
- [ISO Increments] (→ [ISO Increments]: 629)
- [Extended ISO] (→ [Extended ISO]: 629)
- [Exposure Offset Adjust.] (→ [Exposure Offset Adjust.]: 630)
- [Face Priority In Multi Metering] (→ [Face Priority In Multi Metering]: 630)
- [AWB Lock Setting] (→ [AWB Lock Setting]: 631)
- [Color Space] (→ [Color Space]: 632)
- [Exposure Comp. Reset] (→ [Exposure Comp. Reset]: 632)
- [Auto Exposure in P/A/S/M] (→ [Auto Exposure in P/A/S/M]: 632)
- [CreativeVideo Combined Set.] (→ [CreativeVideo Combined Set.]: 633)

 **[Focus/Shutter] (→[Custom] menu ([Focus/Shutter]): 634)**

- [Focus/Shutter Priority] (→[Focus/Shutter Priority]: 634)
- [Focus Switching for Vert / Hor] (→[Focus Switching for Vert / Hor]: 634)
- [AF/AE Lock Hold] (→[AF/AE Lock Hold]: 634)
- [AF+MF] (→[AF+MF]: 635)
- [MF Assist] (→[MF Assist]: 635)
- [MF Guide] (→[MF Guide]: 636)
- [Focus Ring Lock] (→[Focus Ring Lock]: 636)
- [Show/Hide AF Mode] (→[Show/Hide AF Mode]: 636)
- [Pinpoint AF Setting] (→[Pinpoint AF Setting]: 637)
- [AF-Point Scope Setting] (→[AF-Point Scope Setting]: 637)
- [Shutter AF] (→[Shutter AF]: 637)
- [Human Eye Detection Display] (→[Human Eye Detection Display]: 638)
- [Half-Press Shutter] (→[Half-Press Shutter]: 638)
- [Assign REC to Shutter Button] (→[Assign REC to Shutter Button]: 638)
- [Quick AF] (→[Quick AF]: 638)
- [Eye Sensor AF] (→[Eye Sensor AF]: 639)
- [Looped Focus Frame] (→[Looped Focus Frame]: 639)
- [Enlarged Live Display(Video)] (→[Enlarged Live Display(Video)]: 639)

 **[Operation] (→[Custom] menu ([Operation]): 640)**

- [Q.MENU Settings] (→[Q.MENU Settings]: 640)
- [Touch Settings] (→[Touch Settings]: 640)
- [Lock Lever Setting] (→[Lock Lever Setting]: 641)
- [Fn Button Set] (→[Fn Button Set]: 642)
- [WB/ISO/Expo. Button] (→[WB/ISO/Expo. Button]: 643)
- [ISO Displayed Setting] (→[ISO Displayed Setting]: 643)
- [Exposure Comp. Disp. Setting] (→[Exposure Comp. Disp. Setting]: 643)
- [Dial Set.] (→[Dial Set.]: 644)
- [Joystick Setting] (→[Joystick Setting]: 645)
- [Video Rec. Button (Remote)] (→[Video Rec. Button (Remote)]: 646)

 **[Monitor / Display (Photo)] (→[Custom] menu ([Monitor / Display (Photo)]: 647)**

- [Auto Review] (→[Auto Review]: 647)
- [Constant Preview] (→[Constant Preview]: 647)
- [Histogram] (→[Histogram]: 648)
- [Photo Grid Line] (→[Photo Grid Line]: 649)
- [Live View Boost] (→[Live View Boost]: 649)
- [Night Mode] (→[Night Mode]: 650)
- [LVF/Monitor Disp. Set] (→[LVF/Monitor Disp. Set]: 651)
- [Expo.Meter] (→[Expo.Meter]: 653)
- [Focal Length] (→[Focal Length]: 653)
- [Blinking Highlights] (→[Blinking Highlights]: 653)
- [Sheer Overlay] (→[Sheer Overlay]: 654)
- [I.S. Status Scope] (→[I.S. Status Scope]: 655)
- [Level Gauge] (→[Level Gauge]: 656)
- [Luminance Spot Meter] (→[Luminance Spot Meter]: 657)
- [Framing Outline] (→[Framing Outline]: 657)
- [Show/Hide Monitor Layout] (→[Show/Hide Monitor Layout]: 657)

 **[Monitor / Display (Video)] (→[Custom] menu ([Monitor / Display (Video)]): 658)**

- [Log View Assist] (→[Log View Assist]: 658)
- [HLG View Assist] (→[HLG View Assist]: 658)
- [Anamorphic Desqueeze Display] (→[Anamorphic Desqueeze Display]: 658)
- [Monochrome Live View] (→[Monochrome Live View]: 659)
- [Center Marker] (→[Center Marker]: 659)
- [Safety Zone Marker] (→[Safety Zone Marker]: 659)
- [Frame Marker] (→[Frame Marker]: 660)
- [Zebra Pattern] (→[Zebra Pattern]: 660)
- [WFM/Vector Scope] (→[WFM/Vector Scope]: 660)
- [Color Bars] (→[Color Bars]: 661)
- [Video-Priority Display] (→[Video-Priority Display]: 661)
- [Red REC Frame Indicator] (→[Red REC Frame Indicator]: 661)
- [Streaming Blue Frame Indicator] (→[Streaming Blue Frame Indicator]: 661)

 **[IN/OUT] (→[Custom] menu ([IN/OUT]): 662)**

- [HDMI Rec Output] (→[HDMI Rec Output]: 662)
- [Fan Mode] (→[Fan Mode]: 663)
- [Tally Lamp] (→[Tally Lamp]: 663)

 **[Lens / Others] (→[Custom] menu ([Lens / Others]): 664)**

- [Lens Focus Resume] (→[Lens Focus Resume]: 664)
- [Power Zoom Lens] (→[Power Zoom Lens]: 664)
- [Lens Fn Button Setting] (→[Lens Fn Button Setting]: 665)
- [Aperture Ring Increment] (→[Aperture Ring Increment]: 665)
- [Focus Ring Control] (→[Focus Ring Control]: 666)
- [AF Micro Adjustment] (→[AF Micro Adjustment]: 185)
- [Lens Information] (→[Lens Information]: 667)
- [Lens Info. Confirmation] (→[Lens Info. Confirmation]: 667)
- [Vertical Position Info (Video)] (→[Vertical Position Info (Video)]: 667)

[Setup] menu

[Card/File] (→ [Setup] menu ([Card/File]): 669)

- [Card Format] (→ [Card Format]: 669)
- [Double Card Slot Function] (→ [Double Card Slot Function]: 670)
- [USB-SSD] (→ [USB-SSD]: 671)
- [Video File Name] (→ [Video File Name]: 672)
- [CINE Style File Setting] (→ [CINE Style File Setting]: 674)
- [Folder / File Settings] (→ [Folder / File Settings]: 675)
- [File Number Reset] (→ [File Number Reset]: 677)
- [Copyright Information] (→ [Copyright Information]: 677)

[Monitor / Display] (→ [Setup] menu ([Monitor / Display]): 678)

- [Power Save Mode] (→ [Power Save Mode]: 678)
- [Thermal Management] (→ [Thermal Management]: 679)
- [Monitor Frame Rate] (→ [Monitor Frame Rate]: 679)
- [LVF Frame Rate] (→ [LVF Frame Rate]: 680)
- [Monitor Settings]/[Viewfinder] (→ [Monitor Settings]/[Viewfinder]: 680)
- [Monitor Backlight]/[LVF Luminance] (→ [Monitor Backlight]/[LVF Luminance]: 681)
- [Eye Sensor] (→ [Eye Sensor]: 682)
- [Level Gauge Adjust.] (→ [Level Gauge Adjust.]: 682)

- **[IN/OUT] (→[Setup] menu ([IN/OUT]): 683)**
- [Beep] (→[Beep]: 683)
- [Headphone Volume] (→[Headphone Volume]: 683)
- [Sound Monitoring Channel(Play)] (→[Sound Monitoring Channel(Play)]: 684)
- [Streaming] (→[Streaming]: 684)
- [LAN / Wi-Fi[®]] (→[LAN / Wi-Fi[®]]: 685)
- [Bluetooth[®]] (→[Bluetooth[®]]: 685)
- [Frame.io] (→[Frame.io]: 686)
- [USB] (→[USB]: 687)
- [HDMI Connection] (→[HDMI Connection]: 688)
- [Power/Network Indicator] (→[Power/Network Indicator]: 689)

 **[Setting] (→[Setup] menu ([Setting]): 690)**

- [Save to Custom Mode] (→[Save to Custom Mode]: 690)
- [Load Custom Mode] (→[Load Custom Mode]: 690)
- [Custom Mode Settings] (→[Custom Mode Settings]: 690)
- [Save/Restore Camera Setting] (→[Save/Restore Camera Setting]: 691)
- [Reset] (→[Reset]: 691)
- [Activate] (→[Activate]: 692)

 **[Others] (→[Setup] menu ([Others]): 693)**

- [Clock Set] (→[Clock Set]: 693)
- [Time Zone] (→[Time Zone]: 693)
- [System Frequency] (→[System Frequency]: 694)
- [Pixel Refresh] (→[Pixel Refresh]: 694)
- [Sensor Cleaning] (→[Sensor Cleaning]: 695)
- [Language] (→[Language]: 695)
- [Firmware Version] (→[Firmware Version]: 696)
- [Approved Regulations] (→[Approved Regulations]: 696)*

* Depending on the country or area where the camera was purchased, this is not displayed due to differences in specifications.

- [Root Certificate] (→[Root Certificate]: 697)

[My Menu]

₁ [Page 1] (→ [My Menu: 698](#))

₂ [Page 2] (→ [My Menu: 698](#))

₃ [Page 3] (→ [My Menu: 698](#))

 [Edit My Menu] (→ [Edit My Menu: 699](#))

- [Add]
- [Sorting]
- [Delete]
- [Display from My Menu]

[Playback] menu

[Playback Mode] (→[Playback] ([Playback Mode]): 585)

- [Playback Mode] (→[Playback Mode]: 585)
- [Slide Show] (→[Slide Show]: 585)
- [Rotate Disp.] (→[Rotate Disp.]: 586)
- [Picture Sort] (→[Picture Sort]: 586)
- [Magnify from AF Point] (→[Magnify from AF Point]: 586)
- [LUT View Assist (Monitor)] (→[LUT View Assist (Monitor)]: 586)
- [HLG View Assist (Monitor)] (→[HLG View Assist (Monitor)]: 587)
- [Anamorphic Desqueeze Display] (→[Anamorphic Desqueeze Display]: 587)
- [Behavior After Video Playback] (→[Behavior After Video Playback]: 587)

[Process Image] (→[Playback] ([Process Image]): 588)

- [RAW Processing] (→[RAW Processing]: 588)
- [Time Lapse Video] (→[Time Lapse Video]: 588)
- [Stop Motion Video] (→[Stop Motion Video]: 588)

[Add/Delete Info.] (→[Playback] ([Add/Delete Info.]): 589)

- [Protect] (→[Protect]: 589)
- [Rating] (→[Rating]: 589)

[Edit Image] (→[Playback] ([Edit Image]): 590)

- [Resize] (→[Resize]: 590)
- [Rotate] (→[Rotate]: 591)
- [Video Divide] (→[Video Divide]: 591)
- [Copy] (→[Copy]: 592)
- [Video Repair] (→[Video Repair]: 594)

[Others] (→[Playback] ([Others]): 595)

- [Delete Confirmation] (→[Delete Confirmation]: 595)
- [Delete All Images] (→[Delete All Images]: 595)



Wi-Fi / Bluetooth

This chapter explains the Wi-Fi® and Bluetooth® functions of the camera.

• This document refers to both smartphones and tablets as **smartphones**.

- [Connecting to “LUMIX Lab”](#): 717
- [Using “LUMIX Lab”](#): 723
- [Connecting to “LUMIX Sync”](#): 732
- [Using “LUMIX Sync”](#): 750
- [Sending Images from the Camera to a PC](#): 768
- [Wi-Fi Connections](#): 772
- [Send Settings and Selecting Images](#): 782
- [\[LAN / Wi-Fi Setup\] Menu](#): 784

❖ Checking operation of the Wi-Fi and Bluetooth functions

Light (blue)	Monitor	Operation
Lit		The Wi-Fi function is set to on, or there is a connection.
		The Bluetooth function is set to on, or there is a connection.
Blinking		When image data is sent using a camera operation.

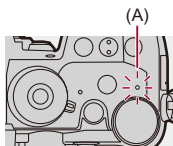

(A) Network connection light



- Do not remove the card or battery or move to an area without any reception while sending images.
- The camera cannot be used to connect to a public wireless LAN connection.
- We strongly recommend that you set an encryption to maintain information security.
- We recommend that you use a sufficiently charged battery when sending images.
- When the remaining battery level is low, it may not be possible to connect to or maintain communication with other devices.
(A message such as [Communication error] is displayed.)
- Images may not be completely sent depending on radio wave conditions.
If the connection is terminated while sending images, images with missing parts may be sent.



- You can set so that the network connection light does not turn on:
(→ [\[Power/Network Indicator\]: 689](#))

Connecting to “LUMIX Lab”

- [Installing “LUMIX Lab”](#): 718
- [Connecting to a Smartphone \(Bluetooth Connection\)](#): 719

Connect with a smartphone which has the “Panasonic LUMIX Lab” (below: “LUMIX Lab”) smartphone app installed.

Use “LUMIX Lab” for [LUT Library] operations and image transfers.

Installing “LUMIX Lab”

“LUMIX Lab” is an application for smartphones provided by Panasonic.



Supported OS

Android™: Android 10 or higher

iOS: iOS 15 or higher

- 1 Connect the smartphone to a network.**
- 2 (Android) Select “Google Play™ Store”.**
(iOS) Select “App Store”.
- 3 Enter “LUMIX” or “panasonic lumix lab” into the search box.**
- 4 Select and install the “Panasonic LUMIX Lab”**  .



- This can also be downloaded via the QR code displayed with [REAL TIME LUT].
 - Use the latest version.
 - Supported OSs are current as of May 2024 and are subject to change.
 - Read the [Help] in the “LUMIX Lab” menu for further details on how to operate.
 - The app may not operate correctly depending on your smartphone.
- For information on the “LUMIX Lab”, refer to the following support site:
<https://panasonic.jp/support/global/cs/dsc/>
(English only)

Connecting to a Smartphone (Bluetooth Connection)

Follow a simple connection setup procedure (pairing) to connect to a smartphone that supports Bluetooth Low Energy.

- For the first-time connection, pairing settings are required.

When connecting the second and subsequent times, the connection is automatic when you turn on the camera's Bluetooth function.



Supported smartphones

Android™: Android 10 or higher with Bluetooth 4.0 or higher (excluding those that do not support Bluetooth Low Energy)

iOS: iOS 15 or higher

- **Turn on the Bluetooth function on the smartphone beforehand.**

1 On the smartphone, start up “LUMIX Lab”.

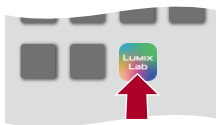

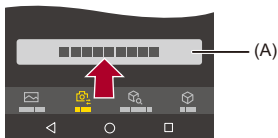

2 View the content in the displayed guidance and start using the app.

3 Switch to the [Camera] screen and select [Pair The Camera].



(A) [Pair The Camera]



4 Set the camera to Bluetooth pairing standby state.

- **MENU/SET** → [] → [] → [Bluetooth] → [Bluetooth Function] → [ON]
- The camera enters the pairing standby state.
- When the camera is detected, it is displayed in “LUMIX Lab”.

5 Select the camera to be connected in “LUMIX Lab”.

- Pairing is executed when you select [Pairing] in the confirmation screen.



- The paired smartphone is registered as a paired device.
- Even if you set up pairing with more than one smartphone, you can only connect to one smartphone at a time.
- When pairing takes some time, canceling the pairing settings on both the smartphone and camera and re-establishing the connection may result in the camera being detected correctly.
- During Bluetooth connection, [] is displayed in the recording screen. When the Bluetooth function is enabled, but a connection is not established with the smartphone, [] appears translucent.
- Up to 16 smartphones can be registered. If you try to register more than 16 smartphones, the registration information will be deleted from the oldest first.
- It is not possible to connect “LUMIX Lab” and “LUMIX Sync” to the camera at the same time.
- When the following function is being used, [Bluetooth] is not available:
 - [Frame.io Connection]

❖ End Bluetooth Connection



To terminate the Bluetooth connection, turn off the Bluetooth function of the camera.

 ⇒ [] ⇒ [] ⇒ [Bluetooth] ⇒ [Bluetooth Function] ⇒ Select [OFF]



- Even if you terminate the connection, the pairing information for it will not be deleted.

❖ Canceling Pairing

- 1 Cancel the pairing setting of the camera.
 -  ⇒ [] ⇒ [] ⇒ [Bluetooth] ⇒ [Pairing] ⇒ [Delete]
- 2 Select the smartphone for which to cancel the pairing.



- Also cancel the pairing setting on the smartphone.
- When [Reset] in the [Setup] ([Setting]) menu is used to reset the network settings, the information for registered devices is deleted.

Using “LUMIX Lab”

- [LUT Library Operations: 723](#)
- [Import images: 725](#)
- [\[Auto Transfer\]: 727](#)
- [\[Location Logging\]: 730](#)

This explains the functions for operating the camera from “LUMIX Lab”.

LUT Library Operations

Operate “LUMIX Lab” to update the [LUT Library] in the camera.

Getting started:

- Connect the camera to a smartphone by Bluetooth. (→ [Connecting to a Smartphone \(Bluetooth Connection\): 719](#))
- On the smartphone, start up “LUMIX Lab”.

1 Select [LUT Transfer] in the [Camera] screen.

- Connect to the camera with Wi-Fi. Select [Join] to start the connection.

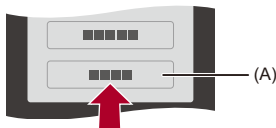

(A) [LUT Transfer]

2 Select the LUT file in the [LUT Library] screen to edit.

- You can transfer, rename, delete or reorder your LUT files.
- A list of LUT files saved to “LUMIX Lab” is shown in [Device].
- A list of LUT files saved to the camera is shown in [Camera].

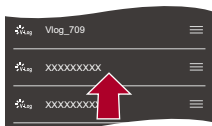

3 Select from [Device] the LUT file to transfer.

4 Select [Transfer to Camera] and update the [LUT Library] on the camera.



- When the following function is being used, [Bluetooth] is not available:
 - [Frame.io Connection]

Import images

Operate “LUMIX Lab” to transfer images from the camera to your smartphone.

Getting started:

- Connect the camera to a smartphone. (→ [Connecting to a Smartphone \(Bluetooth Connection\): 719](#))
- On the smartphone, start up “LUMIX Lab”.

1 Select [Transfer Photo / Video] in the [Camera] screen.

- Connect to the camera with Wi-Fi. Select [Join] to start the connection.

2 Select the image to transfer.

- Touch the checkbox to select.

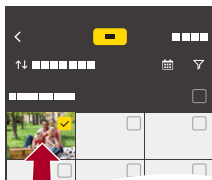

3 Transfer the image.

- Select [].

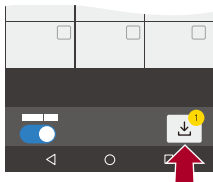

- It is not possible to transfer images with file sizes exceeding 4 GB.
- Images recorded using the following function cannot be transferred:
 - [MOV], [Apple ProRes] videos
- When the following function is being used, [Bluetooth] is not available:
 - [Frame.io Connection]
- The transfer speed slows when the camera temperature rises.



[Auto Transfer]

You can automatically transfer images from the camera to your smartphone as they are taken.

Getting started:

- Connect the camera to a smartphone by Bluetooth. (→ [Connecting to a Smartphone \(Bluetooth Connection\): 719](#))

1 Enable [Auto Transfer] on the camera.

-  ⇒ [] ⇒ [] ⇒ [Bluetooth] ⇒ [Auto Transfer] ⇒ [ON]
- The function can also be enabled in “LUMIX Lab”.
- Connect to the smartphone with Wi-Fi.

2 Check the send settings on the camera and then press



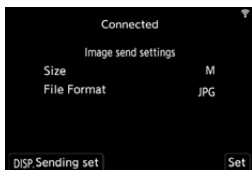

- To change the send setting, press [DISP.]. (→ [Image Send Settings: 782](#))
- Automatic image transfer is possible when [] is displayed on the camera recording screen.



3 Record with the camera.

- [] is displayed in the recording screen of the camera while a file is being sent.

❖ To Stop the Automatic Transfer of Images

-  ⇒ [] ⇒ [] ⇒ [Bluetooth] ⇒ [Auto Transfer] ⇒ Select [OFF]
- A confirmation screen is displayed, asking you to terminate the Wi-Fi connection.



- If the [Bluetooth Function] and [Auto Transfer] settings of the camera are [ON], the camera automatically connects to the smartphone via Wi-Fi and Bluetooth when you turn on the camera.

Start up the “LUMIX Lab” on the smartphone to connect to the camera. Note that if “LUMIX Sync” is running on the smartphone, automatic image transfer may not work properly.



- When [Auto Transfer] is set to [ON], [Wi-Fi Function] cannot be used.
- Automatic image transfer is interrupted while recording or playing back videos. The transfer starts at the start of the file where it was interrupted when the transmission restarts.
- If the camera is turned off during image transfer, and the file sending is interrupted, then turn on the camera to restart the sending.
 - If the storage status of unsent files changes, then sending of files may no longer be possible.
 - If there are many unsent files, then sending of all files may not be possible.
- If automatic image transfer is performed in places where the ambient temperature is high, communications may be interrupted. The camera automatically reconnects when its temperature goes down and automatic image transfer restarts. If automatic image transfer does not restart, turn the camera off then on again to reconnect.
- Images recorded with the following function cannot be transferred automatically:
 - Video recording
- When the following function is being used, [Bluetooth] is not available:
 - [Frame.io Connection]



[Location Logging]

The smartphone sends its location information to the camera via Bluetooth, and the camera performs recording while writing the acquired location information.

Getting started:

- Enable the GPS function on the smartphone.
- Connect the camera to a smartphone by Bluetooth. (→ [Connecting to a Smartphone \(Bluetooth Connection\): 719](#))

1 Enable [Location Logging] on the camera.

-  ⇒ [] ⇒ [] ⇒ [Bluetooth] ⇒ [Location Logging] ⇒ [ON]
- The function can also be enabled in “LUMIX Lab”.
- The camera will enter a mode where location information can be recorded and [GPS] is displayed in the recording screen of the camera.

2 Record images with the camera.

- Location information will be written to the recorded images.



- When [GPS] on the recording screen appears translucent, location information cannot be acquired, therefore data cannot be written.

Smartphone GPS positioning may not be possible if the smartphone is within a building, a bag, or similar. Move the smartphone to a position affording a wide view of the sky to improve positioning performance.

In addition, refer to the operating instructions of your smartphone.

- Images with location information are indicated with [GPS].
- Be sure to pay special attention to the privacy, the likeness rights, etc. of the subject when you use this function. Use at your own risk.
- The smartphone drains its battery faster while acquiring location information.
- When the following function is being used, [Bluetooth] is not available:
 - [Frame.io Connection]

Connecting to “LUMIX Sync”

- [Installing “LUMIX Sync”](#): 733
- [Connecting to a Smartphone \(Bluetooth Connection\)](#): 734
- [Connecting to a Smartphone \(\[Wi-Fi connection\]\)](#): 741
- [Sending Images on the Camera to a Smartphone with Simple Operations](#): 747

Connect with a smartphone which has the “Panasonic LUMIX Sync” (below: “LUMIX Sync”) smartphone app installed.

Use “LUMIX Sync” for remote recording and image transfers.

Installing “LUMIX Sync”

“LUMIX Sync” is an application for smartphones provided by Panasonic.



Supported OS

Android™: Android 10 or higher

iOS: iOS 15 or higher

- 1 Connect the smartphone to a network.**
- 2 (Android) Select “Google Play™ Store”.**
(iOS) Select “App Store”.
- 3 Enter “LUMIX” or “panasonic lumix sync” into the search box.**
- 4 Select and install the “Panasonic LUMIX Sync”** 



- Use the latest version.
- Supported OSs are current as of May 2024 and are subject to change.
- Read the [Help] in the “LUMIX Sync” menu for further details on how to operate.
- The app may not operate correctly depending on your smartphone.

For information on the “LUMIX Sync”, refer to the following support site:

<https://panasonic.jp/support/global/cs/dsc/>

(English only)

Connecting to a Smartphone (Bluetooth Connection)

Follow a simple connection setup procedure (pairing) to connect to a smartphone that supports Bluetooth Low Energy.

When pairing is set up, the camera also automatically connects to the smartphone via Wi-Fi.

- For the first-time connection, pairing settings are required.

For information about connecting for the second and subsequent times

(→ [Connecting to a Paired Smartphone: 739](#))



Supported smartphones

Android™: Android 10 or higher with Bluetooth 4.0 or higher (excluding those that do not support Bluetooth Low Energy)

iOS: iOS 15 or higher

- **Turn on the Bluetooth function on the smartphone beforehand.**

1 On the smartphone, start up “LUMIX Sync”.

- A message regarding device (camera) registration is displayed. Select [Next].

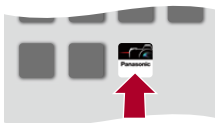

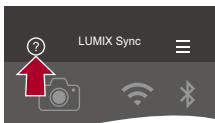

- If you have closed the message, select [?], then register the camera using [Camera registration (pairing)].



2 Check the content in the displayed guide and select [Next] until the screen to register the camera is displayed.

Operating the camera in accordance with the smartphone guide.

3 Set the camera to Bluetooth pairing standby state.

-  ⇒ [] ⇒ [] ⇒ [Bluetooth] ⇒ [Pairing] ⇒ [Add New Device]
- The camera enters pairing standby state and the device name (A) is displayed.

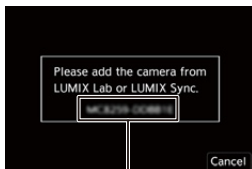

(A)

4 On the smartphone, select the camera's device name.

- (iOS devices) When a message to confirm the change of destination is displayed, select [Join].

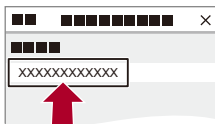

5 When a message indicating that device registration is complete, select [OK].

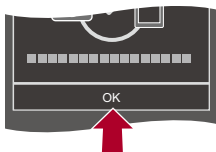

- A Bluetooth connection between the camera and the smartphone will be made.



- The paired smartphone is registered as a paired device.
- During Bluetooth connection, [Bluetooth icon] is displayed in the recording screen. When the Bluetooth function is enabled, but a connection is not established with the smartphone, [Bluetooth icon] appears translucent.
- Up to 16 smartphones can be registered. If you try to register more than 16 smartphones, the registration information will be deleted from the oldest first.
- When the following function is being used, [Bluetooth] is not available:
 - [Frame.io Connection]

❖ End Bluetooth Connection

To terminate the Bluetooth connection, turn off the Bluetooth function of the camera.



 → [] → [] → [Bluetooth] → [Bluetooth Function] → Select [OFF]



- Even if you terminate the connection, the pairing information for it will not be deleted.

❖ Connecting to a Paired Smartphone

Connect paired smartphones using the following procedure.

- 1 Enable the Bluetooth function of the camera.
 - MENU SET ⇒ [] ⇒ [] ⇒ [Bluetooth] ⇒ [Bluetooth Function] ⇒ [ON]
- 2 On the smartphone, start up “LUMIX Sync”.
 - If a message is displayed indicating that the smartphone is searching for cameras, close the message.
- 3 Select [].

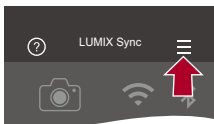

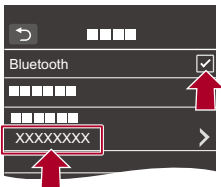

- 4 Select [Bluetooth Setup].
- 5 Turn Bluetooth ON.
- 6 From [Registered camera(s)] items, select the camera's device name.



- Even if you set up pairing with more than one smartphone, you can only connect to one smartphone at a time.
- When pairing takes some time, canceling the pairing settings on both the smartphone and camera and re-establishing the connection may result in the camera being detected correctly.

❖ Canceling Pairing

- 1 Cancel the pairing setting of the camera.
 -  ⇒ [] ⇒ [] ⇒ [Bluetooth] ⇒ [Pairing] ⇒ [Delete]
- 2 Select the smartphone for which to cancel the pairing.



- Also cancel the pairing setting on the smartphone.
- When [Reset] in the [Setup] ([Setting]) menu is used to reset the network settings, the information for registered devices is deleted.

Connecting to a Smartphone ([Wi-Fi connection])

Connect to the smartphone using Wi-Fi. The default setting is to connect with enhanced security using password authentication. It is also possible to easily connect to a smartphone without using a password.

1 Display the QR code (B).

- Press **[MENU/SET]** → **[]** → **[Wi-Fi]** → **[LAN / Wi-Fi]** → **[Wi-Fi Function]** → **[New Connection]** → **[Control With Smartphone]**
- You can also perform the same operation by pressing the Fn button assigned with **[Wi-Fi]**. (→ [Fn Buttons: 597](#))
- Press **[MENU/SET]** or **[]** to enlarge the QR code.



(B)

2 On the smartphone, start up “LUMIX Sync”.

- If a message is displayed indicating that the smartphone is searching for cameras, close the message.

3 Select **[≡]**.

4 Select **[Wi-Fi connection]**.

- 5 **Select [QR code].**
- 6 **Scan the QR code displayed on the screen of the camera using “LUMIX Sync”.**
 - (iOS devices) When a message to confirm the change of destination is displayed, select [Join].

Manually entering a password to connect

- 1 Display the screen in Step 1 (→ [Connecting to a Smartphone \(\[Wi-Fi connection\]\): 741](#)).
- 2 In the setting menu of the smartphone, turn the Wi-Fi function ON.

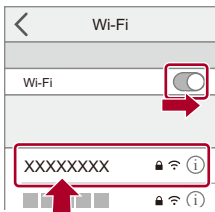



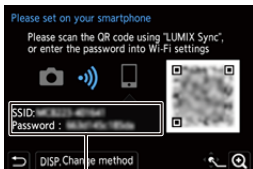



- 3 On the Wi-Fi setup screen, select the SSID (C) displayed on the camera.
- 4 (At the first connection) Enter the password (C) displayed on the camera.



- 5 On the smartphone, start up “LUMIX Sync”.

❖ Connecting Without Using Password Authentication

- 1 Set [Wi-Fi Password] on the camera to [OFF].
 -  ⇒ [] ⇒ [] ⇒ [LAN / Wi-Fi] ⇒ [LAN / Wi-Fi Setup] ⇒ [Wi-Fi Password] ⇒ [OFF]
- 2 Set the camera to Wi-Fi connection standby status.
 -  ⇒ [] ⇒ [] ⇒ [LAN / Wi-Fi] ⇒ [Wi-Fi Function] ⇒ [New Connection] ⇒ [Control With Smartphone]
 - The SSID (D) of the camera is displayed on the screen.
 - You can also perform the same operation by pressing the Fn button assigned with [Wi-Fi]. (⇒ [Fn Buttons: 597](#))



(D)

- 3 In the setting menu of the smartphone, turn the Wi-Fi function ON.
- 4 Select the SSID displayed on the camera.

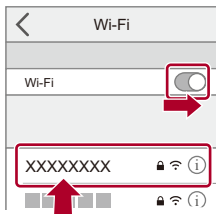

- 5 On the smartphone, start up “LUMIX Sync”.





- 6 (At the first connection) Confirm the device name displayed on the camera and then select [Yes].



- When a device different than the one you want to connect to is displayed, the camera will automatically connect to that device if you select [Yes].
If there are other Wi-Fi connection devices nearby, we recommend using either QR code or manual password input to connect with password authentication.
(→ [Connecting to a Smartphone \(\[Wi-Fi connection\]\): 741](#))
- When the following functions are being used, [Wi-Fi Function] is not available:
 - [Streaming Function]
 - [Auto Transfer]
 - [Frame.io Connection]

❖ Connection Methods Other Than the Default Settings

When connecting with [Via Network], or [WPS Connection] in [Direct], follow the steps below:

- 1 Display the connection method setting screen for the camera.
 -  ⇒ [] ⇒ [] ⇒ [LAN / Wi-Fi] ⇒ [Wi-Fi Function] ⇒ [New Connection] ⇒ [Control With Smartphone]
- 2 Press [DISP.].

Connecting via network



- 1 Select [Via Network] and then press  or  .
 - Connect the camera to a wireless access point. (⇒ [\[Via Network\]: 773](#))
- 2 In the setting menu of the smartphone, turn the Wi-Fi function ON.
- 3 Connect the smartphone to the wireless access point that the camera is connected to.
- 4 On the smartphone, start up “LUMIX Sync”.

Connecting directly

- 1 Select [Direct] and then press  or  .
 - Select [WPS Connection] to connect the camera to a smartphone. (⇒ [\[Direct\]: 777](#))
- 2 On the smartphone, start up “LUMIX Sync”.

❖ Terminating the Wi-Fi Connection

To end the Wi-Fi connection between the camera and smartphone, follow the steps below.

- 1 Press the shutter button halfway to put the camera in recording mode.
- 2 Terminate the Wi-Fi connection.
 -  ⇒ [] ⇒ [] ⇒ [LAN / Wi-Fi] ⇒ [Wi-Fi Function] ⇒ [Yes]
 - You can also perform the same operation by pressing the Fn button assigned with [Wi-Fi]. (⇒ [Fn Buttons: 597](#))
- 3 On the smartphone, close the “LUMIX Sync”.

Sending Images on the Camera to a Smartphone with Simple Operations

You can transfer pictures to a smartphone connected by Bluetooth just by pressing [Q] during playback.

You can also use the menu to connect easily.

- You can also perform the same operation by pressing the Fn button registered with [Send Image (Smartphone)]. (→ [Fn Buttons: 597](#))



Getting started:

- Install “LUMIX Sync” on your smartphone. (→ [Installing “LUMIX Sync”: 733](#))
- Connect the camera to a smartphone by Bluetooth. (→ [Connecting to a Smartphone \(Bluetooth Connection\): 734](#))
- Press [



Send a single image

- 1 Press ◀▶ to select the image.
- 2 Press [Q].
- 3 Select [Single Select].
 - To change the send settings of images, press [DISP.]. (→ [Image Send Settings: 782](#))
- 4 On the smartphone, select [Yes] (for Android devices) or [Join] (for iOS devices).
 - This connects automatically using Wi-Fi.



Send multiple images

- 1 Press [Q].
- 2 Select [Multi Select].
 - To change the send settings of images, press [DISP.]. (→ [Image Send Settings: 782](#))
- 3 Select the images and then transfer.
◀▶ : Select images
 or  : Set/Cancel
[DISP.]: Transfer
- 4 On the smartphone, select [Yes] (for Android devices) or [Join] (for iOS devices).
 - This connects automatically using Wi-Fi.

❖ Using the menu to transfer easily

 ⇒ [] ⇒ [] ⇒ [Bluetooth] ⇒ [LUMIX Sync Settings] ⇒ [Send Image (Smartphone)]

Settings: [Single Select]/[Multi Select]

- If [Single Select], press ▶◀ to select the image and then press  or  to execute.
- If [Multi Select], use the same operation as with “[Send multiple images](#)”. (→ [Send multiple images: 748](#))



- It is not possible to transfer images with file sizes exceeding 4 GB.
- Images recorded using the following function cannot be transferred:
 - [MOV] videos, [Apple ProRes] videos
- When recording, recording is prioritized so it will take time for sending to complete.
- If the camera is turned off, or the Wi-Fi is disconnected before sending is completed, then sending will not restart.
- You may not be able to delete files or use the [Playback] menu while sending.
- When the following functions are being used, [Wi-Fi Function] is not available:
 - [Streaming Function]
 - [Auto Transfer]
 - [Frame.io Connection]

Using “LUMIX Sync”

- [Remote shooting]: 752
- [Shutter Remote Control]: 754
- [Import images]: 757
- [Auto Transfer]: 759
- [Location Logging]: 762
- [Remote Wakeup]: 764
- [Auto Clock Set]: 766
- [Camera settings copy]: 767

This explains the functions for operating the camera from “LUMIX Sync”. Functions described in this document with the () symbol require a smartphone that supports Bluetooth Low Energy.



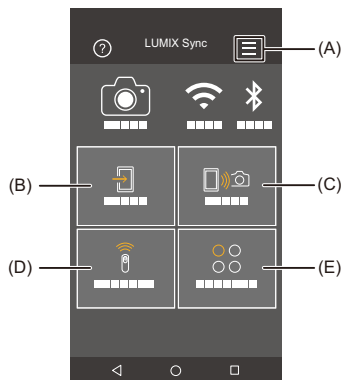

❖ Home Screen

When you start up “LUMIX Sync”, the home screen is displayed.



- (A)  : App settings (→ [Connecting to a Paired Smartphone: 739](#), [Connecting to a Smartphone \(\[Wi-Fi connection\]\): 741](#), [\[Remote Wakeup\]: 764](#))

This allows connection settings, camera power operations, and displays Help.

- (B)  : [Import images] (→ [\[Import images\]: 757](#))
- (C)  : [Remote shooting] (→ [\[Remote shooting\]: 752](#))
- (D)  : [Shutter Remote Control] (→ [\[Shutter Remote Control\]: 754](#))
- (E)  : [Others] ([Camera settings copy]) (→ [\[Camera settings copy\]: 767](#), [Streaming Function: 796](#))

[Remote shooting]

You can use the smartphone to record from a remote location while viewing the live view images from the camera.

Getting started:

- Connect the camera to a smartphone. (→ [Connecting to a Smartphone \(Bluetooth Connection\): 734](#), [Connecting to a Smartphone \(\[Wi-Fi connection\]\): 741](#))
- On the smartphone, start up “LUMIX Sync”.

1 Select ([Remote shooting]) in the home screen.

- (iOS devices) When a message to confirm the change of destination is displayed, select [Join].

2 Start recording.

- The recorded image is saved on the camera.

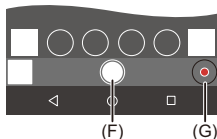

(F) Takes a picture

(G) Starts/ends the video recording





- When used in combination with [Auto Transfer], it is possible to automatically transfer the remotely recorded images to a smartphone. (→ [\[Auto Transfer\]: 759](#))



- Certain features, including some settings, may not be available.
- When the following function is being used, [Bluetooth] is not available:
 - [Frame.io Connection]

❖ Operation Method During Remote Recording

Set either the camera or the smartphone as the priority control device to be used during remote recording.

 → [] → [] → [LAN / Wi-Fi] → [LAN / Wi-Fi Setup] → Select [Priority of Remote Device]

[Camera]

Operation is possible on both the camera and the smartphone.

- The camera's dial settings, etc. cannot be changed with the smartphone.

[Smartphone]

Operation is possible only on the smartphone.

- The camera's dial settings, etc. can be changed with the smartphone.
- To end remote recording, press any of the buttons on the camera to turn on the screen, and select [End].

-
- The default setting is [Camera].



- The setting of this function cannot be changed while the connection is active.

[Shutter Remote Control]

Bluetooth

You can use the smartphone as a remote control for the shutter.

Getting started:

- Connect the camera to a smartphone by Bluetooth. (→ [Connecting to a Smartphone \(Bluetooth Connection\): 734](#))
- On the smartphone, start up “LUMIX Sync”.

- 1 Select [] ([Shutter Remote Control]) in the home screen.**
- 2 Start recording.**



Starts/ends the video recording







Takes a picture

- [Bulb Recording: 755](#)
-

❖ Bulb Recording

The shutter can be kept open from the start to end of recording, which is useful for recording of starry skies or night scenery.

Getting started:



- Set the camera to [M] mode. (→ [Manual Exposure Mode: 315](#))
 - Set the camera shutter speed to [B] (Bulb). (→ [\[B\] \(Bulb\): 319](#))
- 1 Touch [] to start recording (keep touching, without removing your finger).
 - 2 Remove your finger from [] to end recording.
 - Slide [] in the direction of [LOCK] to record with the shutter button locked in a fully-pressed state.
(Slide [] back to its original position or press the camera shutter button to end recording)
 - During [B] (Bulb) recording, if the Bluetooth connection is broken, then carry out Bluetooth connection again, then end recording from the smartphone.

❖ Shortening the Return Time from [Sleep Mode]

You can shorten the time it takes for the camera to return from [Sleep Mode] when the [Shutter Remote Control] is used.

Getting started:

- Connect the camera to a smartphone by Bluetooth. (→ [Connecting to a Smartphone \(Bluetooth Connection\): 734](#))
- Set [Remote Wakeup] in [LUMIX Sync Settings] to [ON]. (→ [\[Remote Wakeup\]: 764](#))

 ⇒ [] ⇒ [] ⇒ [Bluetooth] ⇒ [LUMIX Sync Settings] ⇒ Select [Returning from Sleep Mode]

[Import / Remote Priority]

Shortens the time to return when using [Import images] or [Remote shooting].

[Remote Shutter Priority]

Shortens the time to return when using [Shutter Remote Control].



- To use the [Shutter Remote Control] to cancel [Sleep Mode] on the camera, set [Bluetooth] in the [Setup] ([IN/OUT]) menu as follows, then connect via Bluetooth:
 - [Remote Wakeup] ([LUMIX Sync Settings]): [ON] (→ [\[Remote Wakeup\]: 764](#))
 - [Auto Transfer]: [OFF] (→ [\[Auto Transfer\]: 759](#))
- The camera cannot be turned on by using [Shutter Remote Control].
- When the following function is being used, [Bluetooth] is not available:
 - [Frame.io Connection]

[Import images]

Transfer an image stored on the card to the smartphone connected via Wi-Fi.

Getting started:

- Connect the camera to a smartphone. (→ [Connecting to a Smartphone \(Bluetooth Connection\): 734](#), [Connecting to a Smartphone \(\[Wi-Fi connection\]\): 741](#))
- On the smartphone, start up “LUMIX Sync”.

1 Select [] ([Import images]) in the home screen.

- (iOS devices) When a message to confirm the change of destination is displayed, select [Join].

2 Select the image to transfer.

- You can switch the card displayed by touching (H).



3 Transfer the image.

- Select [➡].
- If the image is a video, you can play it back by touching [(▶)] at the center of the screen.



- When a video is played back, this has a small data size and is transmitted using “LUMIX Sync”, therefore its image quality will differ from that of the actual video recording.
Depending on the smartphone and on the usage conditions, the image quality may deteriorate or the sound may skip during video or picture playback.
- It is not possible to transfer images with file sizes exceeding 4 GB.
- Images recorded using the following function cannot be transferred:
 - [MOV] videos, [Apple ProRes] videos
- When the following function is being used, [Bluetooth] is not available:
 - [Frame.io Connection]
- The transfer speed slows when the camera temperature rises.

[Auto Transfer]

Bluetooth

You can automatically transfer recorded pictures to a smartphone as they are taken.

Getting started:

- Connect the camera to a smartphone by Bluetooth. (→ [Connecting to a Smartphone \(Bluetooth Connection\): 734](#))

1 Enable [Auto Transfer] on the camera.

-  → [] → [] → [Bluetooth] → [Auto Transfer] → [ON]

- If a confirmation screen is displayed on the camera asking you to terminate the Wi-Fi connection, select [Yes] to terminate it.

2 On the smartphone, select [Yes] (for Android devices) or [Join] (for iOS devices).

- The camera automatically makes a Wi-Fi connection.

3 Check the send settings on the camera and then press

-  or  .

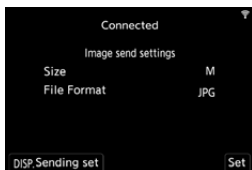

- To change the send setting, press [DISP.]. (→ [Image Send Settings: 782](#))
- Automatic image transfer is possible when [] is displayed on the camera recording screen.



4 Record with the camera.

- [] is displayed in the recording screen of the camera while a file is being sent.

❖ To Stop the Automatic Transfer of Images

 ⇒ [] ⇒ [] ⇒ [Bluetooth] ⇒ [Auto Transfer] ⇒ Select [OFF]

- A confirmation screen is displayed, asking you to terminate the Wi-Fi connection.



- If the [Bluetooth Function] and [Auto Transfer] settings of the camera are [ON], the camera automatically connects to the smartphone via Wi-Fi and Bluetooth when you turn on the camera.

Start up the “LUMIX Sync” on the smartphone to connect to the camera. Note that if “LUMIX Lab” is running on the smartphone, automatic image transfer may not work properly.



- Images are not transferred while the recording screen of the camera is displayed on the smartphone in [Remote shooting].
- When [Auto Transfer] is set to [ON], [Wi-Fi Function] cannot be used.
- Automatic image transfer is interrupted while recording or playing back videos. The transfer starts at the start of the file where it was interrupted when the transmission restarts.
- If the camera is turned off during image transfer, and the file sending is interrupted, then turn on the camera to restart the sending.
 - If the storage status of unsent files changes, then sending of files may no longer be possible.
 - If there are many unsent files, then sending of all files may not be possible.
- Images recorded with the following function cannot be transferred automatically:
 - Video recording
- When the following function is being used, [Bluetooth] is not available:
 - [Frame.io Connection]

[Location Logging]



Bluetooth

The smartphone sends its location information to the camera via Bluetooth, and the camera performs recording while writing the acquired location information.

Getting started:

- Enable the GPS function on the smartphone.
- Connect the camera to a smartphone by Bluetooth. (→ [Connecting to a Smartphone \(Bluetooth Connection\): 734](#))

1 Enable [Location Logging] on the camera.

-  ⇒ [] ⇒ [] ⇒ [Bluetooth] ⇒ [Location Logging] ⇒ [ON]
- The camera will enter a mode where location information can be recorded and [GPS] is displayed in the recording screen of the camera.

2 Record images with the camera.

- Location information will be written to the recorded images.



- When [GPS] on the recording screen appears translucent, location information cannot be acquired, therefore data cannot be written.

Smartphone GPS positioning may not be possible if the smartphone is within a building, a bag, or similar. Move the smartphone to a position affording a wide view of the sky to improve positioning performance.

In addition, refer to the operating instructions of your smartphone.



- Images with location information are indicated with [GPS].
- Be sure to pay special attention to the privacy, the likeness rights, etc. of the subject when you use this function. Use at your own risk.
- The smartphone drains its battery faster while acquiring location information.
- When the following function is being used, [Bluetooth] is not available:
 - [Frame.io Connection]

[Remote Wakeup]

Bluetooth

Even when the camera is turned off, the smartphone can be used to start the camera and record images, or check the recorded images.

Getting started:

- 1 Connect to a smartphone using Bluetooth. (→ [Connecting to a Smartphone \(Bluetooth Connection\): 734](#))
- 2 Enable [Remote Wakeup] on the camera.
 -  ⇒ [] ⇒ [] ⇒ [Bluetooth] ⇒ [LUMIX Sync Settings] ⇒ [Remote Wakeup] ⇒ [ON]
- 3 Set the camera on/off switch to [OFF].
- 4 On the smartphone, start up “LUMIX Sync”.

❖ Turning On the Camera

Select [Remote shooting] in the “LUMIX Sync” home screen.

- (iOS devices) When a message to confirm the change of destination is displayed, select [Join].
- The camera turns on, and automatically connects using Wi-Fi.

❖ Turning Off the Camera

- 1 Select [] in the “LUMIX Sync” home screen.
- 2 Select [Turn off the camera].
- 3 Select [Power OFF].



- When [Auto Transfer] is set to [ON], images recorded while remote operation is running are automatically transferred to a smartphone.
If [Power OFF] is selected while there are still unsent images, sending is resumed when the camera is next turned on.
- When [Remote Wakeup] has been set, the Bluetooth function continues to work even if the camera on/off switch is set to [OFF], so the battery will drain.
- When the following function is being used, [Bluetooth] is not available:
 - [Frame.io Connection]

[Auto Clock Set]



Bluetooth

Synchronize the clock and the time zone setting of the camera with those of a smartphone.

Getting started:

- Connect the camera to a smartphone by Bluetooth. (→ [Connecting to a Smartphone \(Bluetooth Connection\): 734](#))

Enable [Auto Clock Set] on the camera.

-  ⇒ [] ⇒ [] ⇒ [Bluetooth] ⇒ [LUMIX Sync Settings] ⇒ [Auto Clock Set] ⇒ [ON]



- When the following function is being used, [Bluetooth] is not available:
 - [Frame.io Connection]

[Camera settings copy]

Bluetooth

This saves the camera's settings information to the smartphone. Saved settings information can be loaded to the camera, letting you set the same settings on multiple cameras.

Getting started:

- Connect the camera to a smartphone by Bluetooth. (→ [Connecting to a Smartphone \(Bluetooth Connection\): 734](#))

1 Select [] ([Others]) → [] ([Camera settings copy]) in the “LUMIX Sync” home screen.

2 Save or load settings information.

- Read the [Help] in the “LUMIX Sync” menu for further details on how to operate the “LUMIX Sync”.



- Only settings information from the same model can be loaded.
- When transferring settings information, a Wi-Fi connection is automatically created.
(iOS devices) When a message to confirm the change of destination is displayed, select [Join].
- You can save or load the settings information of items that are the same as those in [Save/Restore Camera Setting] under the [Setup] ([Setting]) menu. (→ [List of Default Settings/Custom Saving/Settings Available for Copying: 919](#))
- When the following function is being used, [Bluetooth] is not available:
 - [Frame.io Connection]

Sending Images from the Camera to a PC

Send recorded images to the PC connected with Wi-Fi.



Supported OS

Windows: Windows 10, Windows 11

Mac: macOS 12.0 to 12.7, 13.0 to 13.6, 14.1 to 14.2

Getting started:

- Turn on the PC.
- Create a destination folder for images.
- If the workgroup of the destination PC has been changed from the standard setting, change the corresponding setting of the camera in [PC Connection]. (→[PC Connection]: 785)

❖ Create a Destination Folder for Images

When using Windows (Example for Windows 10)

- 1 Select the destination folder and then right-click.
- 2 Select [Properties] and then enable folder sharing.



When using Mac (Example for macOS 12.0)

- 1 Select the destination folder and then click the items in the following order.
[File] ➔ [Get Info]
- 2 Enable folder sharing.



- Create a PC account name (up to 254 characters) and password (up to 32 characters) consisting of alphanumeric characters.
A destination folder may not be created if the account name includes non-alphanumeric characters.
- When the computer name (NetBIOS name for Mac) contains a space (blank character), etc., it may not be recognized.
In that case, we recommend changing the name to one consisting only of 15 or less alphanumeric characters.
- Refer to the operating instructions for your PC or Help on the OS for detailed setting procedures.

1 Select the method for sending images on the camera.

-  → [] → [] → [LAN / Wi-Fi] → [Wi-Fi Function] → [New Connection] → [Send Images to PC While Recording]/[Send Images Stored in the Camera to PC]

2 Connect the camera and PC by Wi-Fi.

- Select [Via Network] (→ [\[Via Network\]: 773](#)) or [Direct] (→ [\[Direct\]: 777](#)), and then connect.

3 Enter the computer name of the PC you want to connect to (for Mac, the NetBIOS name).

- How to enter characters (→ [Entering Characters: 108](#))

4 Select a folder for storing images.



- Folders sorted by sent date will be created in the selected folder, and images will be saved there.

5 Check the send settings and then press or .

- To change the send setting, press [DISP.]. (→ [Image Send Settings: 782](#))

6 (When [Send Images to PC While Recording] is selected) Take pictures.

- [] is displayed in the recording screen of the camera while a file is being sent.
- To end the connection, follow the steps below:

 ⇒ [] ⇒ [] ⇒ [LAN / Wi-Fi] ⇒ [Wi-Fi Function] ⇒ [Yes]

(When [Send Images Stored in the Camera to PC] is selected) Select an image. (→ [Selecting Images: 783](#))

- To end the connection, select [Exit].



- If the screen for a user account and password entry appears, enter the one you set on your PC.
- When the firewall of the OS, security software, etc. is enabled, connecting to the PC may not be possible.
- When recording, recording is prioritized so it will take time for sending to complete.
- If the camera is turned off, or the Wi-Fi is disconnected before sending is completed, then sending will not restart.
- You may not be able to delete files or use the [Playback] menu while sending.
- When the following functions are being used, [Wi-Fi Function] is not available:
 - [Streaming Function]
 - [Auto Transfer]
 - [Frame.io Connection]

❖ Images That Can be Sent

The images that can be sent depend on the method used for sending them.

Images that can be sent	
[Send Images to PC While Recording]	[Send Images Stored in the Camera to PC]
JPEG/RAW	JPEG/RAW/MP4/MOV/Apple ProRes



- Depending on the OS version, these may not be displayed correctly.
- Sending may not be possible depending on your device.
- It may not be possible to send images recorded with devices other than this camera, or images edited or processed on a PC.

Wi-Fi Connections

- [\[Via Network\]: 773](#)
- [\[Direct\]: 777](#)
- [Connect to Wi-Fi Using Previously Saved Settings: 779](#)
- [Fn Button Assigned with \[Wi-Fi\]: 781](#)

When [New Connection] has been selected in [Wi-Fi Function] in [LAN / Wi-Fi] of the [Setup] ([IN/OUT]) menu, select the connection method from either [Via Network] or [Direct] to connect.

On the other hand, when you use [Select a destination from History] or [Select a destination from Favorite], the camera connects to the selected device with the previously-used settings.

[Via Network]

Connect the camera and destination device through the wireless access point.

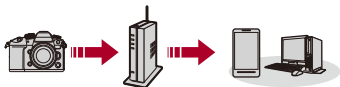

Select the method for connecting to a wireless access point.

Settings: [WPS (Push-Button)]/[WPS (PIN code)]/[From List] (→[WPS (Push-Button)]: 774, [WPS (PIN code)]: 774, [From List]: 775)



- After selecting [Via Network] once, the camera will connect to the previously-used wireless access point.
To change the wireless access point used for connection, press [DISP.] and change the connection destination.
- Check the operating instructions and settings of the wireless access point.

❖ [WPS (Push-Button)]

Press the WPS button on the wireless access point to set up a connection.

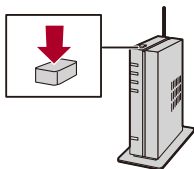

Press the wireless access point WPS button until it switches to WPS mode.

Example)



❖ [WPS (PIN code)]

Enter a PIN code into the wireless access point to set up a connection.

- 1 On the camera screen, select the wireless access point you are connecting to.
- 2 Enter the PIN code displayed on the camera screen into the wireless access point.
- 3 Press  or  of the camera.

❖ [From List]

Searches for a wireless access point to use, and connects to this.



- Confirm the encryption key of the wireless access point.

- 1 Select the wireless access point you are connecting to.
 - Press [DISP.] to run a wireless access point search again.
 - If no wireless access point is found (→ [Connecting by Manual Input: 776](#))
- 2 (If network authentication is encrypted) Enter the encryption key.
 - How to enter characters (→ [Entering Characters: 108](#))

❖ Connecting by Manual Input



- Check the SSID, network authentication, encryption, and encryption key of the wireless access point you are using.

- 1 In the screen in Step 1 of “[From List]”, select [Manual Input]. (→[From List]: 775)
- 2 Enter the SSID of the wireless access point you are connecting to, and then select [Set].
 - How to enter characters (→[Entering Characters: 108])
- 3 Select the network authentication.

[WPA3-SAE]/[WPA3/WPA2]/[WPA2-PSK]/[WPA2/WPA-PSK]

Supported encryption: [TKIP], [AES]

[No Encryption]

- 4 (When other than [No Encryption] is selected) Enter the encryption key and then select [Set].

[Direct]

Directly connect the camera and the destination device.



Select the method for connecting with the destination device.

[WPS Connection]

[WPS (Push-Button)]: Press the WPS button on the destination device to connect.

- On the camera, press [DISP.] to extend the connection wait time.

[WPS (PIN code)]: Enter the PIN code into the camera, and connect.

[Manual Connection]

Search for the camera on the destination device to connect.

- 1 Select the network authentication.

[WPA3]/[WPA3/WPA2]

- If [Wi-Fi Password] in [LAN / Wi-Fi Setup] is [OFF], this is not displayed if the connected device is [Smartphone].

- 2 Enter the SSID and password displayed on the camera into the device.

- If [Wi-Fi Password] in [LAN / Wi-Fi Setup] is [OFF], the password is not displayed if the connected device is [Smartphone].

Select the SSID to establish a connection. (→ [Connecting to a Smartphone \(Wi-Fi connection\): 741](#))







- Please also refer to the operating instructions for the device to be connected.

Connect to Wi-Fi Using Previously Saved Settings

Use the Wi-Fi connection history to connect using the same settings as previously.

1 Display the Wi-Fi connection history.

-  ⇒ [] ⇒ [] ⇒ [LAN / Wi-Fi] ⇒ [Wi-Fi Function] ⇒ [Select a destination from History]/[Select a destination from Favorite]



2 Select the History item to connect to.

- Press [DISP.] to confirm details of the connection history.

❖ Register to Favorite

You can register the Wi-Fi connection history to Favorite.

1 Display the Wi-Fi connection history.



-  ⇒ [] ⇒ [] ⇒ [LAN / Wi-Fi] ⇒ [Wi-Fi Function] ⇒ [Select a destination from History]

2 Select the History item to register and then press ►.

3 Enter a registration name and then select [Set].

- How to enter characters (→ [Entering Characters: 108](#))
- A maximum of 30 characters can be entered. A two-byte character is treated as two characters.

❖ Editing Items Registered in Favorite

- 1 Display items registered to Favorite.
 -  ⇒ [] ⇒ [] ⇒ [LAN / Wi-Fi] ⇒ [Wi-Fi Function] ⇒ [Select a destination from Favorite]
- 2 Select the History item to edit in Favorite and then press ►.

[Remove from Favorite]

[Change the Order in Favorite]

Specify the destination location of the desired item to change the display order.

[Change the Registered Name]

Enter characters to change the registered name.

- How to enter characters (⇒ [Entering Characters: 108](#))
-



- The number of items that can be saved in History is limited. Register frequently-used connection settings to Favorite.
- When [Reset] in the [Setup] ([Setting]) menu is used to reset the network settings, the content registered in History and Favorite is deleted.
- If the device you want to connect to (PC, etc.) is connected to a wireless access point other than the camera, you cannot connect the device to the camera using [Direct].
Change the Wi-Fi settings of the device you want to connect to so that the access point to be used is set to the camera. You can also select [New Connection] and reconnect the devices. (⇒ [Sending Images from the Camera to a PC: 768](#))
- It may be difficult to connect to networks to which many devices are connected. In these cases, connect using [New Connection].
- When the following functions are being used, [Wi-Fi Function] is not available:
 - [Streaming Function]
 - [Auto Transfer]
 - [Frame.io Connection]

Fn Button Assigned with [Wi-Fi]

You can perform the following operations by pressing the Fn button assigned with [Wi-Fi] after connecting to Wi-Fi. (→ [Fn Buttons: 597](#))

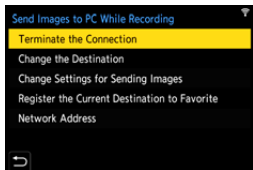

[Terminate the Connection]

Terminates the Wi-Fi connection.

[Change the Destination]

Terminates the Wi-Fi connection, and allows you to select a different Wi-Fi connection.

[Change Settings for Sending Images]

Sets the image size, file format, and other items for sending recorded images.

(→ [Image Send Settings: 782](#))

[Register the Current Destination to Favorite]

Registers the current connection destination or method so that you can easily connect with the same connection settings next time.

[Network Address]

Displays the MAC address and IP address of the camera. (→ [\[Network Address Display \(Wi-Fi\)\]: 786](#))

-
- Depending on the Wi-Fi function being used or the connection destination, you may not be able to perform some of these operations.

Send Settings and Selecting Images

- [Image Send Settings: 782](#)
- [Selecting Images: 783](#)

Image Send Settings

Set the size, file format, and other items for sending the image to the destination device.

- 1 **After Wi-Fi connection, the send settings confirmation screen will be displayed, so press [DISP.].**

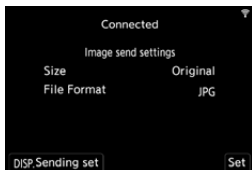

- 2 **Change the send settings.**

[Size]

Resize the image to send.

[Original]/[Change] ([L], [M], [S], [XS] or [VGA])

[File Format]

Sets the file format of images to send.

[JPG]/[RAW+JPG]/[RAW]



- This setting is possible when the destination supports the sending of RAW images from this camera. (→ [Images That Can be Sent: 771](#))
-

Selecting Images





When sending by [Send Images Stored in the Camera to PC], select the images using the following procedure.

- 1 Select [Single Select] or [Multi Select].**
- 2 Select the image.**

[Single Select] setting

- 1 Press ◀▶ to select an image.
- 2 Press  or .

[Multi Select] setting

- 1 Press ▲▼◀▶ to select an image and then press  or . (Repeat this)
 - To cancel the setting, press  or  again.
 - Images are displayed separately by card slot.
To switch the card to display, press [].
 - Selecting images at once is possible only for the images in a single card.



- 2 Press [DISP.] to execute.

[LAN / Wi-Fi Setup] Menu

This configures the settings required for the wired LAN/Wi-Fi function. The settings cannot be changed while connected with wired LAN/Wi-Fi.

Displaying the [LAN / Wi-Fi Setup] menu.

-  →  →  → [LAN / Wi-Fi] → [LAN / Wi-Fi Setup]

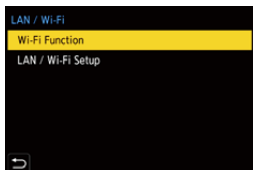

[Wi-Fi Frequency Bands]

This sets the frequency band used for direct connection with a smartphone.

[2.4GHz]: Connection uses the 2.4 GHz frequency band.

[5GHz]: Connection uses the 5 GHz frequency band.

- Depending on the region, local regulations, etc. may prohibit you from using the 5 GHz frequency band outdoors. If this is the case, when outdoors, connect to the smartphone using [2.4GHz] for the Wi-Fi connection.

[Priority of Remote Device]

This sets either the camera or the smartphone as the priority control device to be used during remote recording. (→ [Operation Method During Remote Recording: 753](#))

[IP Address Setting (LAN)]

Sets the IP address when connecting via wired LAN.

You can select to either automatically allocate the IP address with the DHCP, or set any static IP address.

[DHCP Server]: Select when the camera is to be connected as the DHCP server.

[DHCP Client]: Select when the camera is to be connected as the DHCP client.

(Default setting)

[Static IP Address]: Select when connecting using an IP set in [Static IP Address Setting].

[Static IP Address Setting]: Set the IP address to be used in [Static IP Address].

[IP Address]: The default setting is <192.168.0.2>.

[Subnet Mask]: The default setting is <255.255.255.0>.

[Default Gateway]: The default setting is <192.168.0.1>.

Use the correct combinations when setting the [IP Address], [Subnet Mask], and

[Default Gateway].

- Consult the administrator of the network you are using for detailed information about the DHCP settings and static IP address settings.
- If you have modified settings in [IP Address Setting (LAN)], turn the camera off and on again.

[Wi-Fi Password]

When connecting to a smartphone, you can use a password for enhanced security.

(→ [Connecting to a Smartphone \(\[Wi-Fi connection\]: 741\)](#))

- You can change the password by using [Device Name/Password]. (→ [\[Device Name/Password\]: 786](#))

[PC Connection]

You can set the workgroup.

To send images to a PC, you need to connect to the same workgroup as the destination PC.

(The default setting is "WORKGROUP".)

- To change the workgroup name, press  or  and enter the new workgroup name.
 - To return to the default settings, press [DISP].
-

[Device Name/Password]

You can change the camera name (SSID) and password.

- Press [DISP.] to change the device name and password.
 - The number of characters you can enter is a maximum of 32 for the device name and between 8 and 63 for the password.
-

[LAN / Wi-Fi Function Lock]

You can set a password to prevent incorrect operation and use of the wired LAN/Wi-Fi functions by a third party and to protect personal information that may be found either in the camera itself or in images recorded with the camera.

[Setup]: Enter any 4-digit numbers as the password.

- Once a password is set, you are required to enter it when you select [LAN / Wi-Fi Setup] or [Streaming].

[Cancel]: Cancel the password.

[Network Address Display (LAN)]

Displays the MAC address and IP address of the camera when connecting via wired LAN.

[Network Address Display (Wi-Fi)]

Displays the MAC address and IP address of the camera when connecting via Wi-Fi.



- If you forget your password, you can use [Reset] in the [Setup] ([Setting]) menu to reset the network settings and thereby reset the password.



- How to enter characters (→ [Entering Characters: 108](#))

Frame.io Camera to Cloud

This camera is compatible with “Frame.io Camera to Cloud”.

By connecting the camera to the internet via Wi-Fi, you can upload still images and proxy videos directly to the Frame.io platform.

* This does not guarantee all of the functions of “Frame.io Camera to Cloud”.

- [Connecting with Frame.io: 788](#)
- [\[Send Images to Frame.io\]: 793](#)
- [\[Upload Setup\]: 794](#)

Connecting with Frame.io

 → [] → [] → [Frame.io] → [Frame.io Connection] →
Select [ON]

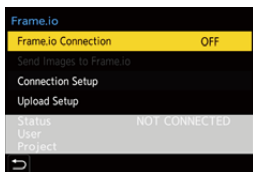

- Perform [Wi-Fi Connection Setting] and [Pairing(Frame.io)] when connecting for the first time.

[Wi-Fi Connection Setting]

Select [New connection] and connect via Wi-Fi to the access point.

[Pairing(Frame.io)]

A pairing code is displayed on the camera.

Log into Frame.io from a PC, etc., and enter the pairing code in the device registration screen.

- This can also be set by selecting [Frame.io Connection] → [SET] → [Pairing(Frame.io)].
-

- You can view the [Status] in relation to Frame.io in the [Frame.io] menu screen.
 - [NOT CONNECTED]: Connection with Frame.io not started
 - [CONNECTING]: Currently trying to connect with Frame.io (incomplete)
 - [CONNECTED]: Connection with Frame.io completed
 - [CONNECTED(PAUSED)]: Camera connection has been paused on the Frame.io site
- The user name ([User]) and project name ([Project]) are displayed on the camera when the connection is completed.



- If connection with Frame.io fails repeatedly (authentication failure), try the pairing setting procedure again.
- If it is not possible to connect with Frame.io, check the connection method and then try setting [Frame.io Connection] to [ON] again.
- Depending on the status of the camera, it may take some time to transfer images.



- When the following functions are being used, [Frame.io] is not available:
 - [Bluetooth]
 - [Streaming]
 - [USB]
 - Tethered recording

❖ Changing the Connection Method

MENU / **SET** → [] → [] → [Frame.io] → [Connection Setup] →
Select [Connection Method]

[Wi-Fi]

Connect to an access point via Wi-Fi.

[USB Tethering]

Connect using the USB tethering function of a smartphone.

- When a smartphone is used, the camera is connected to the internet via mobile data communications (4G, 5G, etc.) enabling you to connect with Frame.io from locations where a router is not available, when you are out and about, for example.

- 1 Connect the camera and the smartphone using a USB connection cable.

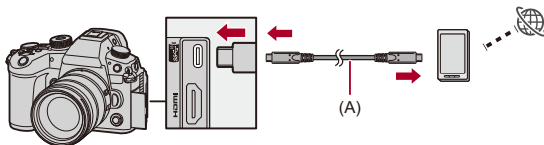

(A) USB connection cable (commercially available)

- 2 Enable the USB tethering function on the smartphone.
 - Select [USB Tethering] (for Android devices) or [Personal Hotspot] (for iOS devices) on the smartphone.
 - If a confirmation message appears on the smartphone screen asking for permission to enable access by the connected device, grant permission. Connection is not complete until permission is given.
 - Please also refer to the operating instructions of your smartphone.
-

- If the connection method is changed while connected with Frame.io, the connection with Frame.io is temporarily broken, and then it is reestablished after the change.



Notes When Using USB Tethering

- For information about the tethering function of your smartphone, refer to the operating instructions of the smartphone and the contract you have with the cell-phone provider.
Depending on the contract you have, there may be limitations on tethering or it may incur large additional charges.
- **Set [Frame.io Connection] to [OFF] if you are not going to connect with Frame.io.**
When set to [ON], if the [Connection Method] is set to [USB Tethering], power is supplied from the battery of this camera to the connected device, so the battery will be consumed faster.
- **For information about the high temperature display**
When the temperature of the camera rises, [] appears blinking on the screen. If you continue to use the camera, a message indicating that the camera cannot be used is displayed on the screen and some functions, such as recording and HDMI output, will be stopped. Wait for the camera to cool down and for the message indicating that the camera can be used again. When the message indicating that it can be used again is displayed, turn the camera off then on again.
- The network connection light does not light when connected to the internet via USB tethering.
- After connecting via USB tethering, when charging the battery in the camera, make sure that the charging light of the camera lights red.
If the charging light does not light, reconnect the USB connection cable while the camera is turned off.

❖ Changing the Wi-Fi Connection Destination

Change the access point, etc., while connected to Frame.io.

 → [] → [] → [Frame.io] → [Connection Setup] →
Select [Wi-Fi Connection Setting]

- Press [DISP.] to reselect the connection destination.

❖ Disconnecting from Frame.io

 → [] → [] → [Frame.io] → [Frame.io Connection] →
Select [OFF]

- The upload queue is not cleared even if you break the connection (Wi-Fi) with Frame.io.

❖ Unpairing (Frame.io)

 → [] → [] → [Frame.io] → [Frame.io Connection] →
[SET] → Select [Delete]

- This deletes the information for pairing with Frame.io and breaks the connection (Wi-Fi) with Frame.io.
- The upload queue is cleared.







[Send Images to Frame.io]

When [Frame.io Connection] is set to [ON], the images to upload can be reserved manually.

 → [] → [] → [Frame.io] → Select [Send Images to Frame.io]

- You also can display the screen for selecting images by pressing the Fn button which has been assigned [Send Images to Frame.io].
- The images filtered by [Upload File Format] in [Upload Setup] are displayed.



- Press   to select the images and press  to add check marks.
- Images are added to the end of the upload queue when you press [DISP.].
- During playback, images reserved for transfer are indicated with [ >] and images already transferred are indicated with [ ].

[Upload Setup]

Make settings related to uploading of images.

 → [] → [] → [Frame.io] → **Select [Upload Setup]**

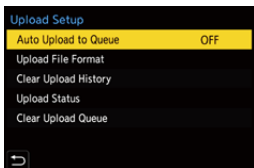

[Auto Upload to Queue]

When set to [ON], images are added to the Frame.io upload queue as they are recorded.

[Upload File Format]

Select the format of the files to be automatically uploaded.

With [Send Images to Frame.io], you can filter the file types to display when making image selections.

You can upload proxy videos and pictures (JPEG/RAW).

[Clear Upload History]

Removes the icon indicating an image is uploaded from images that have been uploaded.

[Upload Status]

You can see the projects that are connected and the number of files remaining to be uploaded, etc.

Press [DISP.] to see even more detailed information.

[Clear Upload Queue]

Clears the upload queue for Frame.io.

Removes the icon indicating that images are in the queue for uploading.

- Images that are removed from the upload queue are not uploaded to Frame.io.
-

❖ Notes About the Upload Queue (Transfer Reservation List)

When the camera has been connected to Frame.io, the images in the upload queue are uploaded to Frame.io.

- If there are images remaining in the upload queue, uploading is continued even if the camera on/off switch is set to [OFF]. The power is turned off when uploading is completed. If [Exit] is selected to turn off the power, uploading is resumed when the camera is next turned on.
- Uploading is canceled when the connection with Frame.io is broken and then is resumed when the connection is reestablished.
- The upload queue is cleared in the following cases:
 - [Clear Upload Queue] is executed
 - Pairing with Frame.io is canceled
- Do not remove the battery while the camera is still turned on. The upload queue will not be kept properly.

Streaming Function

Live stream the camera's images and audio over the internet.

There are the following connection methods for streaming:

Wi-Fi connection with an access point such as a router or smartphone/USB tethering connection with a smartphone

- Streaming can be started with operations on a smartphone or on the camera.
- Compatible with RTMP/RTMPS*.

You can stream to video sharing websites that support these protocols.

- When a smartphone is used, the camera is connected to the internet via mobile data communications (4G, 5G, etc.) enabling you to live stream from locations where a router is not available, when you are out and about, for example.

Wired LAN connection with a PC

- A wired LAN connection with a PC requires a commercially available USB ethernet adaptor.
- Operate the streaming software installed on the PC to stream.
- Compatible with RTP/RTSP*.

You can stream to video sharing websites that support these protocols.

* Communication protocol for streaming



- **Video cannot be recorded to the cards while using streaming function.**
- For information about the tethering function of your smartphone, refer to the operating instructions of the smartphone and the contract you have with the cell-phone provider.
Depending on the contract you have, there may be limitations on tethering or it may incur large additional charges.
- For information about USB ethernet adaptors whose operation has been verified with this camera, check the following support site. (As of May 2024)
<https://panasonic.jp/support/global/cs/dsc/connect/index.html>
(English only)

- [Stream by Operating a Smartphone: 798](#)
- [Stream by Operating the Camera: 802](#)
- [Stream by Operating the PC: 807](#)
- [Streaming Settings: 810](#)
- [Notes When Using the Streaming Function: 818](#)

Stream by Operating a Smartphone



Operate the smartphone app “LUMIX Sync” to start streaming. (Supported protocols: RTMP/RTMPS)

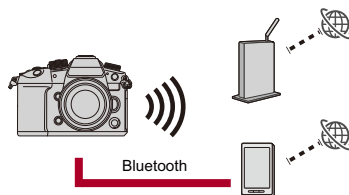

Getting started:

- Install “LUMIX Sync” on your smartphone. (→ [Installing “LUMIX Sync”: 733](#))
- Connect the camera to a smartphone by Bluetooth. (→ [Connecting to a Smartphone \(Bluetooth Connection\): 734](#))
- (When using USB tethering) Confirm that the camera and smartphone are not connected via USB.

1 Set the camera's recording mode to [CAM].

- Set the mode dial. (→ [Selecting the Recording Mode: 82](#))

2 Set streaming on the smartphone.

- 1 Start up "LUMIX Sync".
- 2 Select [Others] ➔ [Live streaming] in the "LUMIX Sync" home screen.
- 3 Select a video sharing website or [Stream with RTMP/RTMPS].
 - Select [Stream with RTMP/RTMPS] to enter the streaming destination address manually.
- 4 Make detailed streaming settings.
 - The setting items depend on the selection made in Step 3. Follow the smartphone screen to make the settings.

[Connection Method]: Select [Wi-Fi] or [USB Tethering].

- If you select [Wi-Fi], set the wireless access point that the camera will connect to for streaming.

[Streaming Quality]: Sets the image quality that will be streamed.

[Privacy settings]: Selects privacy setting.

[Stream URL]: Enter the streaming URL acquired from the streaming service.

[Stream key]: Enter the streaming key acquired from the streaming service.

- 5 Select [Set to the camera].
 - If the message [Unable to confirm security of the streaming address. Continue?] is displayed, check that the URL of the streaming destination is correct before continuing the connecting operation.
 - The settings will be sent from the smartphone to the camera.
 - [Streaming Function] on the camera turns [ON] and [▲] is displayed on the recording screen.
 - (When using Wi-Fi) The camera connects via Wi-Fi to the access point.

3 (When using USB tethering) Set the USB tethering connection.

- 1 Connect the camera and the smartphone using a USB connection cable.

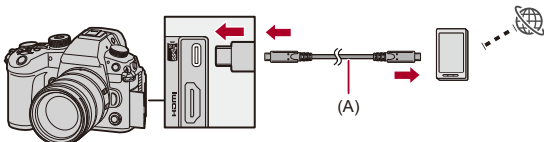

(A) USB connection cable (commercially available)

- 2 Enable the USB tethering function on the smartphone.
 - Select [USB Tethering] (for Android devices) or [Personal Hotspot] (for iOS devices) on the smartphone.
 - If a confirmation message appears on the smartphone screen asking for permission to enable access by the connected device, grant permission. Connection is not complete until permission is given.
 - Please also refer to the operating instructions of your smartphone.

4 Start streaming.

- Select [Start streaming] on “LUMIX Sync”.
- [📹] is displayed on the camera’s recording screen.

5 Stop streaming.

- Select [Stop streaming] on “LUMIX Sync”.

6 End the streaming function.

- If you select [End streaming] on “LUMIX Sync”, the [Streaming Function] of the camera will be set to [OFF].



- Displays a blue frame on the screen during streaming:
(→ [\[Streaming Blue Frame Indicator\]: 661](#))
- When you press the shutter button or the video rec. button on the camera to start streaming, you can record the images being streamed on an external recorder connected via HDMI:
(→ [\[Outputting Control Information to an External Recorder: 529\]](#))

Stream by Operating the Camera



Sets the streaming destination on a PC and saves it to a card. Insert the card to the camera and start streaming by operating the camera. (Supported protocols: RTMP/RTMPS)

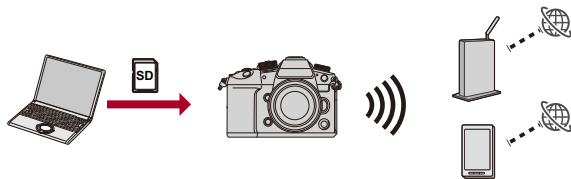

Getting started:

- Install “LUMIX Network Setting Software” to the PC.
<https://panasonic.jp/support/global/cs/dsc/download/index3.html>
(English only)

Supported OS

Windows: Windows 10, Windows 11

Mac: macOS 12.0 to 12.7, 13.0 to 13.6, 14.0 to 14.2

- Insert a card into the PC.
- (When using USB tethering) Confirm that the camera and smartphone are not connected via USB.

1 Set the streaming destination on the PC.



- 1 Start up “LUMIX Network Setting Software”.
- 2 Login to a video sharing website and retrieve a streaming destination (URL, stream key).
- 3 Input the streaming destination (URL, stream key) to “LUMIX Network Setting Software” and select [Next].
- 4 Set the output destination (card) and file name, and select [Save].
 - Characters that can be set in [File Name]: Alphabet (uppercase), numbers, up to 8 characters.
 - To prevent usage from a third party, you can secure the streaming destination with a password.
 - Put a check mark in [Password].
 - When you set a password, password input will be required when loading the streaming destination.
 - You can enter any 4-digit numbers as the password.
 - The settings set at step 3 is saved in the card.

2 Set the camera’s recording mode to [P/M].

- Set the mode dial. (→ [Selecting the Recording Mode: 82](#))

3 Insert into the camera the card onto which you have saved the streaming destination in Step 1.

4 Load the streaming destination onto the camera.

-  ⇒ [] ⇒ [] ⇒ [Streaming] ⇒ [Streaming Setup] ⇒ [Save/Load Streaming Address] ⇒ [Load]
- If a password is set at step 1, input the password.

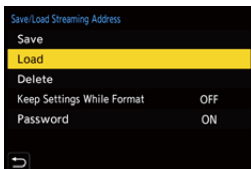

- The streaming destination address can be displayed and changed.
(⇒[Streaming Setup]: 812)



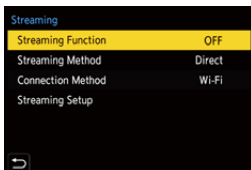

5 Set up streaming settings on the camera.

-  ⇒ [] ⇒ [] ⇒ [Streaming]



- 1 Select [Direct] in [Streaming Method].
- 2 Select [Wi-Fi] or [USB Tethering] in [Connection Method].
- 3 Select [Streaming Quality] in [Streaming Setup]. (⇒Streaming Settings: 810)
- 4 (When using Wi-Fi) Set [Wi-Fi Connection Setting] in [Streaming Setup]. (⇒Streaming Settings: 810)

6 Set [Streaming Function] on the camera to [ON].

-  → [] → [] → [Streaming] → [Streaming Function] → [ON]
- If the message [Unable to confirm security of the streaming address. Continue?] is displayed, check that the URL of the streaming destination is correct before continuing the connecting operation.
- [] is displayed on the recording screen.
- (When using Wi-Fi) The camera connects via Wi-Fi to the access point.

7 (When using USB tethering) Set the USB tethering connection.

- 1 Connect the camera and the smartphone using a USB connection cable.

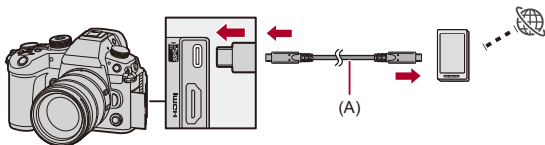

(A) USB connection cable (commercially available)

- 2 Enable the USB tethering function on the smartphone.
 - Select [USB Tethering] (for Android devices) or [Personal Hotspot] (for iOS devices) on the smartphone.
 - If a confirmation message appears on the smartphone screen asking for permission to enable access by the connected device, grant permission. Connection is not complete until permission is given.
 - Please also refer to the operating instructions of your smartphone.



8 Start streaming.

- Press the shutter button or video rec. button.
- [] is displayed on the recording screen.
- Operations to start streaming may be needed on the video sharing website.

9 Stop streaming.

- Press the shutter button or video rec. button.

10 End the streaming function.

-  → [] → [] → [Streaming] → [Streaming Function] → [OFF]



- Displays a blue frame on the screen during streaming:
(→ [\[Streaming Blue Frame Indicator: 661\]](#))
- When you press the shutter button or the video rec. button on the camera to start streaming, you can record the images being streamed on an external recorder connected via HDMI:
(→ [\[Outputting Control Information to an External Recorder: 529\]](#))

Stream by Operating the PC



Via a commercially available USB ethernet adaptor, connect the camera to the router/PC with a wired LAN, then use the streaming software installed on the PC to IP stream. (Supported protocols: RTP/RTSP)

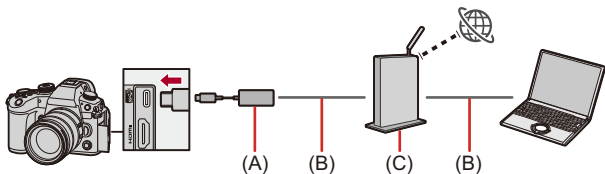

(A) USB ethernet adaptor (commercially available)

(B) LAN cable (commercially available)

(C) Router

Getting started:

- Install the RTP/RTSP compatible streaming software onto your PC.

1 Set the camera's recording mode to [M].

- Set the mode dial. (→ [Selecting the Recording Mode: 82](#))

2 Set [IP Address Setting (LAN)] to the same network as the PC.

-  → [] → [] → [LAN / Wi-Fi] → [LAN / Wi-Fi Setup] → [IP Address Setting (LAN)] (→ [IP Address Setting (LAN)]: 785)

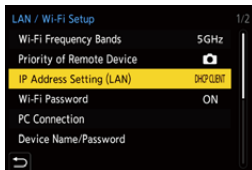

- If you have modified settings in [IP Address Setting (LAN)], turn the camera off and on again.

3 Set up streaming settings on the camera.

-  → [] → [] → [Streaming]

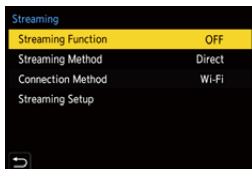

- 1 In [Streaming Method], select [Via PC Software], and set [Connection Method] to [LAN].
- 2 In [Streaming Setup], set [Streaming Quality] and [RTSP Port].
- 3 Set [Streaming Function] to [ON].
 - [▲] is displayed on the recording screen.

4 Connect the commercially available USB ethernet adaptor to the camera, then use commercially available LAN cables to connect the camera and the PC to a router.

5 Use your streaming software to start/end streaming.

- Set the URL as follows in your streaming software:
rtsp://(IP address of this camera)/stream
- If the [RTSP Port] has been changed from the default setting (554), set as follows:
rtsp://(IP address of this camera):(RTSP port)/stream
- When streaming starts, [] is displayed on the recording screen of the camera.
- For details about operation methods, refer to the operating instructions of the streaming software.



- Displays a blue frame on the screen during streaming:
(→ [\[Streaming Blue Frame Indicator\]: 661](#))
- When you press the shutter button or the video rec. button on the camera, you can record the images being streamed on an external recorder connected via HDMI:
(→ [Outputting Control Information to an External Recorder: 529](#))



- During IP streaming, just starting “LUMIX Tether” establishes the wired LAN connection with “LUMIX Tether”, meaning that you do not have to operate the camera.
(The live view is not displayed on the “LUMIX Tether” screen during streaming.)

Streaming Settings



Configures streaming settings.

 →  →  → **Select [Streaming]**

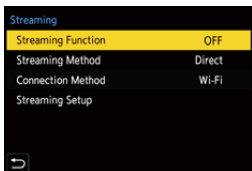

[Streaming Function]	<p>Enables/disables the streaming function.</p> <ul style="list-style-type: none"> • The settings may not be reflected when the camera is connected to USB devices. Reconnect the USB connection cable if this occurs. • Before setting to [ON], set [Streaming Method], [Connection Method], and [Streaming Setup].
[Streaming Method]	<p>[Direct]: Directly stream from the camera to the live streaming service. (Supported protocols: RTMP/RTMPS)</p> <p>[Via PC Software]: Use the streaming software on a PC to stream. (Supported protocols: RTP/RTSP)</p>
[Connection Method]	<p>[Wi-Fi]^{*1}: Connect to an access point such as a smartphone via Wi-Fi.</p> <p>[USB Tethering]^{*1}: Connect using the USB tethering function of a smartphone.</p> <p>[LAN]^{*2}: Use a commercially available USB ethernet adaptor to connect to a PC with a LAN cable.</p>
[Streaming Setup]	<p>Make advanced settings for streaming.</p> <p>(→ [Streaming Setup]: 812)</p>

*1 Displayed when [Streaming Method] is set to [Direct].

*2 Displayed when [Streaming Method] is set to [Via PC Software].

❖ [Streaming Setup]

[Streaming Quality]	Sets the image quality that will be streamed. (→ [Streaming Quality]: 815)
[RTSP Port]^{*1}	Set the RTSP port number. [CHANGE]: Change to any number. (Up to 65535) [DEFAULT]: Set to the default setting (554). • The following numbers cannot be set: 0 to 553, 555 to 1023, 1900, 10669, 10670, 15740, 50001, and 60606
[Streaming Address]^{*2}	Displays the current streaming destination address. To change the streaming destination, press [DISP.] first then input the streaming destination address.

[Save/Load Streaming Address]^{*2}	[Save]	<p>Saves the current streaming destination address to the card.</p> <ul style="list-style-type: none"> • If saving new data, then select [New File], and if overwriting an existing file, select that existing file. • When [New File] is selected, a screen to select the file name to save as is displayed. <p>[OK]: Saves using the file name on the screen. [Change the file name]: Changes the file name and saves the file.</p> <ul style="list-style-type: none"> • Available characters: alphabetic characters (uppercase), numerals, up to 8 characters <p>When you set [Password], the screen for entering the password (4-digit numeral) is displayed.</p>
	[Load]	<p>Copy the streaming destination address in the card to the camera.</p> <ul style="list-style-type: none"> • If you set a password when you saved the streaming destination address on the card, the password entry screen is displayed.
	[Delete]	<p>Deletes the streaming destination address within the card.</p>
	[Keep Settings While Format]	<p>When formatting the card, you can keep the streaming destination address saved in the card and format.</p>
	[Password]	<p>Select whether to set a password when you save the streaming destination address on the card.</p>
[Wi-Fi Connection Setting]^{*3}	<p>Sets the wireless access point the camera connects to when streaming. To change the destination, press [DISP.]. (→[Via Network]: 773)</p>	

- *1 Displayed when [Streaming Method] in [Streaming] is set to [Via PC Software].
- *2 Displayed when [Streaming Method] in [Streaming] is set to [Direct].
- *3 Displayed when [Connection Method] in [Streaming] is set to [Wi-Fi].



- Up to 10 streaming destination addresses can be saved onto one card.
- Set [Wi-Fi Connection Setting] before setting [Streaming Function] to [ON].
- If you forget the password, save the streaming destination address again with a new password.



- How to enter characters (→ [Entering Characters: 108](#))

❖ [Streaming Quality]

- Video compression format:
 - [H.265] streaming quality: H.265/HEVC
 - [H.264] streaming quality: H.264/MPEG-4 AVC
- Audio format: AAC (2ch)

- (A) Frame rate
 (B) Bit rate (Mbps)
 (C) [Wi-Fi]
 (D) [USB Tethering]
 (E) [LAN]

[System Frequency]: [59.94Hz (NTSC)]								
[Streaming Quality]	[Image Area of Video]		Resolution	(A)	(B)	[Connection Method]		
	FULL	PIXEL PIXEL				(C)	(D)	(E)
[H.265/4K/50M/60p]		✓	3840×2160	59.94p	50	—	—	✓
[H.265/4K/25M/60p]		✓	3840×2160	59.94p	25	—	—	✓
[H.265/4K/25M/30p]	✓	✓	3840×2160	29.97p	25	—	—	✓
[H.265/4K/12.5M/30p]	✓	✓	3840×2160	29.97p	12.5	—	—	✓
[H.265/FHD/20M/60p]	✓	✓	1920×1080	59.94p	20	—	—	✓
[H.265/FHD/16M/60p]	✓	✓	1920×1080	59.94p	16	—	—	✓
[H.265/FHD/12M/30p]	✓	✓	1920×1080	29.97p	12	—	—	✓
[H.265/FHD/6M/30p]	✓	✓	1920×1080	29.97p	6	—	—	✓
[H.264/4K/50M/60p]		✓	3840×2160	59.94p	50	—	—	✓
[H.264/4K/25M/60p]		✓	3840×2160	59.94p	25	—	—	✓
[H.264/4K/25M/30p]	✓	✓	3840×2160	29.97p	25	—	—	✓
[H.264/4K/12.5M/30p]	✓	✓	3840×2160	29.97p	12.5	—	✓	✓
[H.264/FHD/16M/60p]	✓	✓	1920×1080	59.94p	16	✓*	✓	✓
[H.264/FHD/8M/60p]	✓	✓	1920×1080	59.94p	8	✓	✓	✓
[H.264/FHD/6M/30p]	✓	✓	1920×1080	29.97p	6	✓	✓	✓
[H.264/FHD/3M/30p]	✓	✓	1920×1080	29.97p	3	✓	✓	✓
[H.264/HD/6M/60p]	✓	✓	1280×720	59.94p	6	✓	✓	✓

[H.264/HD/4M/30p]	✓	✓	1280×720	29.97p	4	✓	✓	✓
-------------------	---	---	----------	--------	---	---	---	---

[System Frequency]: [50.00Hz (PAL)]

[Streaming Quality]	[Image Area of Video]		Resolution	(A)	(B)	[Connection Method]		
	FULL	PIXEL PIXEL				(C)	(D)	(E)
[H.265/4K/50M/50p]		✓	3840×2160	50.00p	50	—	—	✓
[H.265/4K/25M/50p]		✓	3840×2160	50.00p	25	—	—	✓
[H.265/4K/25M/25p]	✓	✓	3840×2160	25.00p	25	—	—	✓
[H.265/4K/12.5M/25p]	✓	✓	3840×2160	25.00p	12.5	—	—	✓
[H.265/FHD/20M/50p]	✓	✓	1920×1080	50.00p	20	—	—	✓
[H.265/FHD/16M/50p]	✓	✓	1920×1080	50.00p	16	—	—	✓
[H.265/FHD/12M/25p]	✓	✓	1920×1080	25.00p	12	—	—	✓
[H.265/FHD/6M/25p]	✓	✓	1920×1080	25.00p	6	—	—	✓
[H.264/4K/50M/50p]		✓	3840×2160	50.00p	50	—	—	✓
[H.264/4K/25M/50p]		✓	3840×2160	50.00p	25	—	—	✓
[H.264/4K/25M/25p]	✓	✓	3840×2160	25.00p	25	—	—	✓
[H.264/4K/12.5M/25p]	✓	✓	3840×2160	25.00p	12.5	—	✓	✓
[H.264/FHD/16M/50p]	✓	✓	1920×1080	50.00p	16	✓*	✓	✓
[H.264/FHD/8M/50p]	✓	✓	1920×1080	50.00p	8	✓	✓	✓
[H.264/FHD/6M/25p]	✓	✓	1920×1080	25.00p	6	✓	✓	✓
[H.264/FHD/3M/25p]	✓	✓	1920×1080	25.00p	3	✓	✓	✓
[H.264/HD/6M/50p]	✓	✓	1280×720	50.00p	6	✓	✓	✓
[H.264/HD/4M/25p]	✓	✓	1280×720	25.00p	4	✓	✓	✓

* This can be set when the streaming destination is RTMP. (Cannot be set when it is RTMPS.)



- Set a streaming image quality (bit rate) appropriate to the communication speed of your internet connection.
- Images output via HDMI are output with a resolution and frame rate that match [Streaming Quality].
However, when [Streaming Quality] is set to [HD], the output is in [FHD] resolution.

Notes When Using the Streaming Function

● Notes When Using USB Tethering/Wired LAN: 819

- The following functions are not available while you are using the streaming function:
 - [Hybrid Log Gamma] ([Photo Style])
 - [Rec. File Format]
 - [Rec Quality]
 - [Rec Quality (My List)]
 - [Sound Rec Quality]
 - [4ch Audio Recording]
 - [Loop Recording (video)]
 - [Segmented File Recording]
 - [Live Cropping]
 - [Wi-Fi Function] (Wi-Fi connection destination during streaming can be set in [Streaming Setup].)
 - Pairing function of [Bluetooth]
 - [Reset]
- The streaming function is not available when using the following functions:
 - [HDMI RAW Data Output]
 - When [System Frequency] is set to [24.00Hz (CINEMA)]
 - During USB connection (PC)
 - [Frame.io Connection]
 - Tethered recording (except when connected via wired LAN)
- The communication speed depends on the internet connection and the handset, so we recommend that you perform streaming tests beforehand.
- If you turn the camera off without ending the streaming function, when the next time the camera is turned on, it is automatically reconnected to the connection destination that was previously connected.
- The menu screen cannot be displayed while streaming.
- The camera's recording information will not be displayed on the streamed images.
- The required conditions for streaming differ depending on the video sharing website. Check the video sharing website for details.

Notes When Using USB Tethering/Wired LAN

- **When the streaming function is not to be used, set [Streaming Function] to [OFF].**

When set to [ON], if the [Connection Method] is set to [USB Tethering] or [LAN], power is supplied from the battery of this camera to the connected device, so the battery will be consumed faster.

- **For information about the high temperature display (→ [For information about the high temperature display: 136](#))**
- The network connection light does not light when connected to the internet via USB tethering.
- After connecting via USB tethering or wired LAN, when charging the battery in the camera, make sure that the charging light of the camera lights red.
If the charging light does not light, reconnect the USB connection cable while the camera is turned off.

Connecting to Other Devices

This chapter describes connections with other devices, for example, HDMI devices, such as TVs, and PCs.

Connect using either the HDMI socket or the USB port on the camera.

- [Connecting: 821](#)
- [Viewing on a TV: 823](#)
- [Importing Images to a PC: 827](#)
- [Storing on a Recorder: 832](#)
- [Tethered Recording: 833](#)

Connecting



- Check the direction of the terminals and plug in/out straight holding onto the plug. (Inserting these at an angle may cause deformation or malfunction)
- Do not connect the cable to the wrong terminals. This may cause a malfunction.

HDMI socket

Connect the camera and HDMI device (TV, etc.) with a commercially available HDMI cable.

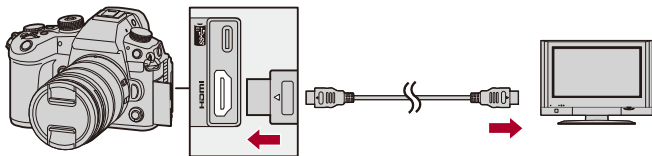

- Use an Ultra High Speed HDMI cable (Type A–Type A plug) with the length less than 3 m (9.8 feet).

USB port

Use a USB connection cable (commercially available) to connect the camera to a PC or recorder.

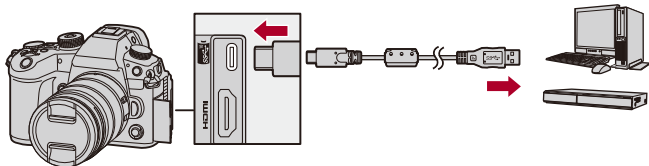

- Use a USB connection cable that complies with the USB standards.

Viewing on a TV

You can connect the camera to a TV or external monitor to view recorded pictures and videos.

Getting started:

- Turn off the camera and TV.

- 1 Connect the camera and TV with a commercially available HDMI cable. (→ [HDMI socket: 821](#))**
- 2 Turn on the TV.**
- 3 Switch the TV input to HDMI input.**
- 4 Turn on the camera.**
- 5 Display the playback screen.**
 - Press [].
 - The recorded images are displayed on the camera and TV.



- With the default settings, pictures are output at the optimal resolution for the connected TV.
The output resolution can be changed in [Output Resolution(Playback)].
(→[Output Resolution(Playback)]: 688)
- Depending on the aspect ratio, gray bands may be displayed on the top and bottom or the left and right of images.
You can change the band color in [Background Color(Playback)] in [HDMI Connection] of the [Setup] ([IN/OUT]) menu. (→[Background Color(Playback)]: 689)
- HDMI output is not possible if you connect a USB connection cable at the same time while [USB Mode] is set to [PC(Storage)].
- The audio of video recorded with [4ch Audio Recording] set to other than [OFF] cannot be output if the external device connected via HDMI is not compatible with 4-channel audio or high-resolution audio.
- Change the screen mode on your TV if images are displayed with the top or bottom cut off.
- Please also refer to the operating instructions for the TV.

❖ Using VIERA Link

VIERA Link (HDAVI Control™) is a function that allows you to use your remote control for the Panasonic TV for easy operations when the camera has been connected to a VIERA Link compatible device using an HDMI cable for automatic linked operations.

(Not all operations are possible.)



- To use VIERA Link, you need to also configure the settings on the TV. For the setting procedure, refer to the operating instructions for the TV.

- 1 Connect the camera to a Panasonic TV compatible with VIERA Link using a commercially available HDMI cable. (→ [HDMI socket: 821](#))
- 2 Turn on the camera.
- 3 Turn on the VIERA Link.
 - ⇒ [] ⇒ [] ⇒ [HDMI Connection] ⇒ [VIERA Link (CEC)] ⇒ [ON]
- 4 Display the playback screen.
 - Press [].
 - The recorded images are displayed on the TV. (The monitor and viewfinder of the camera will turn off.)
- 5 Operate with the remote control for the TV.

Power off link

If you turn off the TV with its remote control, the camera will also turn off.

Automatic input switching

If you turn on the camera and then press [], the input of the TV automatically switches to input to which this camera is connected.

Furthermore, when the TV power is in the standby state, it turns on automatically. (When “Power on link” on the TV is set to “Set”)



- VIERA Link is a unique Panasonic function built on an HDMI control function using the standard HDMI CEC (Consumer Electronics Control) specification. Linked operations with HDMI CEC compatible devices made by other companies are not guaranteed.
- The camera supports “VIERA Link Ver.5”. “VIERA Link Ver.5” is the standard for Panasonic's VIERA Link compatible devices. This standard is compatible with Panasonic's conventional VIERA Link devices.
- Operation using the buttons on the camera will be limited.

Importing Images to a PC

- [Copying Images to a PC: 828](#)
- [Installing Software: 831](#)

If you connect the camera to a PC, you can copy the recorded images to the PC.

You will need to use software that is compatible with the recorded video format in order to play back or edit video on the PC.

You can also use software for processing and editing RAW images.

(→ [Installing Software: 831](#))

Copying Images to a PC

After connecting to the PC, you can copy the recorded images by dragging files and folders on this camera to the PC.



- The camera can be connected to a PC running any of the following OSs which can detect mass storage devices.

Supported OS

Windows: Windows 10, Windows 11

Mac: macOS 12.0 to 12.7, 13.0 to 13.6, 14.0 to 14.2



- Mac:

Supported by “Final Cut Pro X”.

For details on “Final Cut Pro X”, please contact Apple Inc.

Getting started:

- Turn on the camera and PC.

- 1 Connect the camera and PC with the USB connection cable (commercially available). (→USB port: 822)**
- 2 Press ▲▼ to select [PC(Storage)] and then press  or .**
 - Windows: The drive (“LUMIX” or the volume label of the card set with [CINE Style File Setting]) is displayed in [This PC].
 - Mac: The drive (“LUMIX” or the volume label of the card set with [CINE Style File Setting]) is displayed on the desktop.
- 3 Drag the files and folders from the camera to the PC.**

❖ Folder Structure Inside Card

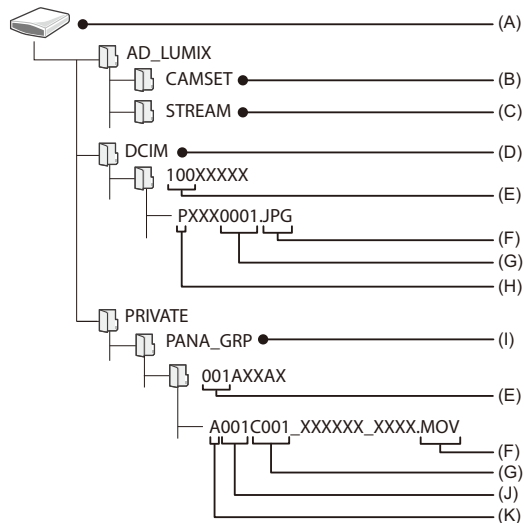

(A) Volume label

When [Video File Name] is set to [Same As Photo(DCF Standard)]: LUMIX

When [Video File Name] is set to [CINE Style]: The volume label of the card set in [CINE Style File Setting]

(B) The camera's setup information

(C) Streaming Settings

(D) Images

(E) Folder number

- (F) JPG: JPEG format pictures
RAW2: RAW format pictures
MP4: MP4 videos
MOV: MOV videos, Apple ProRes videos
- (G) File number
- (H) Color space
P: sRGB
_: AdobeRGB
- (I) CINE Style video
- (J) Card number
- (K) Camera index



- If [USB Mode] is set to [PC(Storage)] in the [Setup] ([IN/OUT]) menu, the camera will be automatically connected to the PC without the [USB Mode] selection screen being displayed. (→[USB Mode]: 687)



- Take care not to turn off the camera while images are being imported.
- After importing of the images is completed, perform the operation to safely remove the USB connection cable on the PC.
- Turn off the camera and disconnect the USB connection cable before removing the card from the camera. Otherwise, the recorded data may be damaged.

Installing Software

Install the software to process and edit RAW images.



- To download the software, your PC needs to be able to connect to the internet.
- Supported OSs are current as of May 2024 and are subject to change.

❖ **SILKYPIX Developer Studio SE**

This software processes and edits RAW images.

Edited images can be saved in a format (JPEG, TIFF, etc.) that can be displayed on a PC.

Check the following site and then download and install the software:

<http://www.isl.co.jp/SILKYPIX/english/p/>

Operating environment

● **Supported OS**

Windows: Windows 10 (64 bit), Windows 11

Mac: macOS 10.13 to 10.15, 11, 12, 13, 14



- For more information such as how to use “SILKYPIX Developer Studio”, refer to the Help or the Adwaa’s support site.

Storing on a Recorder

By connecting the camera to a Panasonic Blu-ray disc recorder or DVD recorder, you can store the pictures and videos.

Getting started:

- Turn on the camera and recorder.
- Insert a card into card slot 1.

- 1 Connect the camera and recorder with the USB connection cable (commercially available). (→ [USB port: 822](#))**
- 2 Press ▲▼ to select [PC(Storage)] and then press  or .**
- 3 Operate the recorder to store the images.**



- If [USB Mode] is set to [PC(Storage)] in the [Setup] ([IN/OUT]) menu, the camera will be automatically connected to the recorder without the [USB Mode] selection screen being displayed. (→ [\[USB Mode\]: 687](#))



- Take care not to turn off the camera while storage is in progress.
- Images such as 4K videos may not be supported depending on your recorder.
- Turn off the camera and disconnect the USB connection cable before removing the card from the camera. Otherwise, the recorded data may be damaged.
- For the storage and playback procedures, refer to the operating instructions for the recorder.

Tethered Recording

- [Installing Software: 834](#)
- [Operating the Camera from a PC: 835](#)
- [Using “LUMIX Tether” with a Wired LAN Connection: 836](#)
- [Remote Control of Multiple Cameras: 838](#)

If you install the “LUMIX Tether” camera control software on your PC, you can connect the camera to the PC via USB and then control the camera from the PC and record while checking the live view on the PC screen (tethered recording).

In addition, you can output via HDMI to an external monitor or TV during tethered recording.

By using a commercially available USB ethernet adaptor, you can use tethered recording by connecting the camera to the PC via a LAN cable. Multiple cameras can also be operated remotely this way.



- For information about USB ethernet adaptors whose operation has been verified with this camera, check the following support site. (As of May 2024)
<https://panasonic.jp/support/global/cs/dsc/connect/index.html>
(English only)

Installing Software

❖ “LUMIX Tether”

This software is for controlling the camera from a PC.

It allows you to change various settings and to record remotely and then save the images to the PC.

Check the following site and then download and install the software:

https://panasonic.jp/support/global/cs/soft/download/d_lumixtether.html

(English only)

Operating environment

● Supported OS

Windows: Windows 10 (64 bit), Windows 11

Mac: macOS 12.0 to 12.7, 13.0 to 13.6, 14.0 to 14.2

● Interface

USB port (SuperSpeed USB (USB 3.1))





- Supported OSs are current as of May 2024 and are subject to change.
- Use the latest version of “LUMIX Tether”.
- To download the software, your PC needs to be able to connect to the internet.
- For how to operate the software, refer to the operation guide for “LUMIX Tether”.

Operating the Camera from a PC

Getting started:

- Turn on the camera and PC.
- Install “LUMIX Tether” on PC.

- 1 Connect the camera and PC with the USB connection cable (commercially available). (→ [USB port: 822](#))**
- 2 Press ▲▼ to select [PC(Tether)] and then press  or .**
 -  is displayed on the camera's screen.
- 3 Use “LUMIX Tether” to operate the camera from the PC.**



- If [USB Mode] is set to [PC(Tether)] in the [Setup] ([IN/OUT]) menu, the camera will be automatically connected to the PC without the [USB Mode] selection screen being displayed. (→ [\[USB Mode\]: 687](#))





- When there is a PC connection with [PC(Tether)], the following functions are not available:
 - [Streaming]
 - [Wi-Fi Function] ([LAN / Wi-Fi])
 - [Bluetooth]
- Tethered recording is not possible while you are using the following function:
 - [Frame.io Connection]

Using “LUMIX Tether” with a Wired LAN Connection

Getting started:



- Turn on the camera and PC.
- Install “LUMIX Tether” on PC.

1 Set the camera as a DHCP server.

- **MENU/SET** → [] → [] → [LAN / Wi-Fi] → [LAN / Wi-Fi Setup] → [IP Address Setting (LAN)] → [DHCP Server]

- If you have modified settings in [IP Address Setting (LAN)], turn the camera off and on again.

2 Set to wired LAN tethering connection.

- **MENU/SET** → [] → [] → [USB] → [Tether(USB ethernet adaptor)] → [ON]

3 Connect the commercially available USB ethernet adaptor to the camera, then use a commercially available LAN cable to connect the camera and the PC.

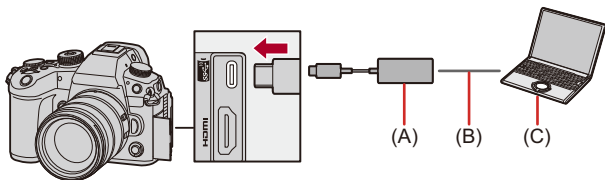

- (A) USB ethernet adaptor (commercially available)
 (B) LAN cable (commercially available)
 (C) A PC on which “LUMIX Tether” is installed

4 Use “LUMIX Tether” to remotely control the camera.

- (Initial connection) Set the password to be used to connect from “LUMIX Tether” to the camera. (Between 8 and 31 characters)
- [] is displayed on the top right of the camera's screen.
- Reconnect the USB connection cable if there is a problem with operation.



Remote Control of Multiple Cameras

A number of cameras can be remotely controlled using “LUMIX Tether”.

Getting started:

- Turn on the camera and PC.
- Install “LUMIX Tether” on PC.

1 Set the camera as a DHCP client (default setting).

-  ⇒ [] ⇒ [] ⇒ [LAN / Wi-Fi] ⇒ [LAN / Wi-Fi Setup] ⇒ [IP Address Setting (LAN)] ⇒ [DHCP Client]
- If there is no DHCP server in the LAN, it is also possible to make the connection by setting one camera as [DHCP Server], and the remainder as [DHCP Client].
- If you have modified settings in [IP Address Setting (LAN)], turn the camera off and on again.

2 Do the operations in “Using “LUMIX Tether” with a Wired LAN Connection” from Step 2.

- Connect the cameras, PC, and router (hub) according to the diagram below.

For example: When there is a DHCP server in the LAN, and the camera is to be connected as a DHCP client

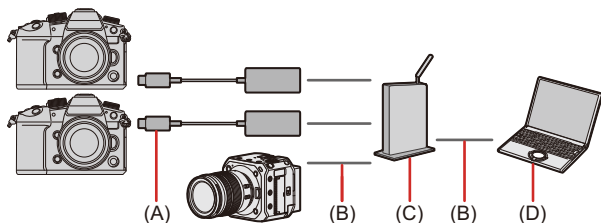

(A) USB ethernet adaptor (commercially available)

(B) LAN cable (commercially available)

(C) Router (or hub)



(D) A PC on which “LUMIX Tether” is installed

- You can use “LUMIX Tether” to remotely control multiple cameras.



- When a wired LAN connection is not to be used, set [Tether(USB ethernet adaptor)] to [OFF].

When set to [ON], power is supplied from the battery of this camera to the connected device, so the battery will be consumed faster.

- When using “LUMIX Tether” with a wired LAN connection, the following functions are not available:
 - [Wi-Fi Function] ([LAN / Wi-Fi])
 - [Bluetooth]
- Tethered recording is not possible while you are using the following function:
 - [Frame.io Connection]
- When recording with multiple tethered cameras, we recommend allocating unique device names to each of the cameras:
[] ⇒ [] ⇒ [LAN / Wi-Fi] ⇒ [LAN / Wi-Fi Setup] ⇒ [Device Name/ Password] ⇒ [Device Name]

Materials

This chapter describes procedures to try when there is a problem and provides information about the specifications for your reference.

- [Digital Camera Accessory System: 842](#)
- [Using Optional Accessories: 844](#)
- [Monitor/Viewfinder Displays: 849](#)
- [Message Displays: 871](#)
- [Troubleshooting: 875](#)
- [Cautions for Use: 890](#)
- [Number of Pictures That Can Be Taken and Available Recording Time with the Battery: 903](#)
- [Number of Pictures That Can Be Taken and Video Recording Time According to Recording Media: 907](#)
- [List of Default Settings/Custom Saving/Settings Available for Copying: 919](#)
- [List of Functions That Can Be Set in Each Recording Mode: 947](#)
- [Specifications: 955](#)
- [Trademarks and Licenses: 973](#)

Digital Camera Accessory System

(Product numbers correct as of May 2024.)

Product name	Product number
Battery Pack	DMW-BLK22
Battery Charger	DMW-BTC15 ^{*1} , DMW-BTCD15 ^{*2}
AC Adaptor	DMW-AC11 ^{*3}
DC Coupler	DMW-DCC18 ^{*2}
Flash	DMW-FL580L, DMW-FL360L, DMW-FL200L
LED Video Light	VW-LED1
Stereo Shotgun Microphone	DMW-MS2
Stereo Microphone	VW-VMS10
XLR Microphone Adaptor	DMW-XLR2
Shutter Remote Control	DMW-RS2
Tripod Grip	DMW-SHGR2, DMW-SHGR1
Tripod Adaptor	DMW-TA1 ^{*4}
Body Cap	DMW-BDC1
Upgrade Software Key	DMW-SFU3A

*1 Supplied with an AC adaptor, an AC cable/AC mains lead and a USB connection cable. (Charging time: Approx. 175 min)

*2 A separately available AC adaptor and USB connection cable are required. It is recommended to use the Panasonic AC Adaptor (DMW-AC11: optional).

*3 Supplied with an AC cable/AC mains lead and USB connection cable.

*4 Use if the attached lens interferes with the tripod head.

- Some optional accessories may not be available in some countries.
- For lens-related optional accessories such as compatible lenses and filters, refer to our catalogs/website, etc.
- For the latest information on optional accessories, refer to our catalogs/website, etc.

Using Optional Accessories

- [Shutter Remote Control \(Optional\): 845](#)
- [Tripod Grip \(Optional\): 847](#)
- [DC Coupler \(Optional\): 848](#)

- For information on the external flash (→ [Using an External Flash \(Optional\): 373](#))
- For information on the external microphone (→ [External Microphones \(Optional\): 424](#))
- For information on the XLR Microphone Adaptor (→ [XLR Microphone Adaptor \(Optional\): 429](#))
- Some optional accessories may not be available in some countries.

Shutter Remote Control (Optional)

You can connect the Shutter Remote Control (DMW-RS2: optional) to use the camera as follows:

- Fully pressing the shutter button without camera shake
- Securing the shutter button during bulb recording and burst recording
- Start/end the video recording
- Using the functions registered in the video rec. button of the Shutter Remote Control

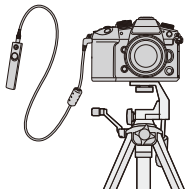



❖ Registering Functions to the Video Rec. Button

You can register a favorite function to the video rec. button on a Shutter Remote Control.

The functions that can be registered are the same as the functions that can be registered to the Fn buttons for recording (→ [Setting Items \(\[Fn Button Set\]/\[Setting in REC mode\]\): 603](#)).

[Video Record] is registered in the default setting.

 →  →  → Select [Video Rec. Button (Remote)]

- Register functions using the same operations as [Fn Button Set]. (→ [Register Functions to the Fn Buttons: 600](#))



- Always use a genuine Panasonic Shutter Remote Control (DMW-RS2: optional).
- Refer to the operating instructions for the Shutter Remote Control for details.

Tripod Grip (Optional)

Attach a Tripod Grip (DMW-SHGR2/DMW-SHGR1: optional) to use it as a grip for recording while walking, a tripod, or a Shutter Remote Control.

- Connect the grip cable to the [REMOTE] socket on the camera.

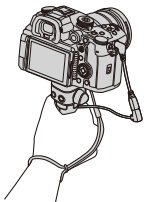

- Always use a genuine Panasonic Tripod Grip (DMW-SHGR2/DMW-SHGR1: optional).
- The [Video Rec. Button (Remote)] menu does not work with the Tripod Grip.
- Do not carry just by holding the hand strap when the camera is attached.
- For details, refer to the operating instructions for the Tripod Grip.

DC Coupler (Optional)

Using a DC Coupler (DMW-DCC18: optional) means you do not have to worry about the remaining battery charge even when you are using an external SSD.



- A separately available AC adaptor and USB connection cable are required. It is recommended to use the Panasonic AC Adaptor (DMW-AC11: optional).
- When the DC Coupler is being mounted, the DC Coupler cover opens, so the structure ceases to be dust and splash resistant.

Do not allow sand, dust and water droplets to adhere to or enter the camera. After use, confirm that no foreign objects are adhering to the DC Coupler cover, then firmly close the cover.





- For details, refer to the operating instructions for the AC Adaptor and DC Coupler.

Monitor/Viewfinder Displays

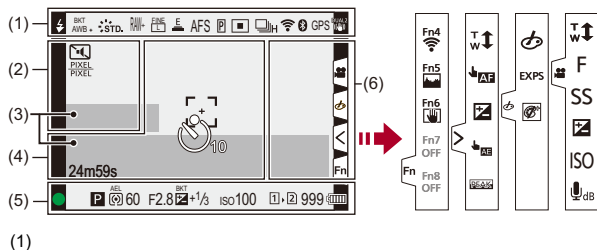







- [Recording Screen: 849](#)
 - [Playback Screen: 866](#)
- The screen is an monitor display example of when [LVF/Monitor Disp. Set] is set to .

Recording Screen



	Flash mode (→ [Flash Mode]: 378)
	Flash setting (→ [Flash Synchro]: 384 , Recording Using a Wireless Flash: 386)
AWBc AWBw   2500K	White balance (→ White Balance (WB): 334)/ Color Temperature (→ Color Temperature Setting: 339)





	White Balance Bracket, White Balance Bracket (Color Temperature) (→ [More Settings] (White Balance Bracket): 276)
AWB + AWB -	Adjusting the white balance (→ Adjusting the White Balance: 340)
AWBL	AWB lock setting (→ [AWB Lock Setting]: 631)
	Photo Style (→ [Photo Style]: 342)
*EXPS	Filter setting (→ [Filter Settings]: 356)/ Filter effect adjustment (→ Adjusting the Filter Effect: 358)
MON LUT HDMI V-Log	LUT View Assist (→ [Log View Assist]: 490)
MON MODE2 HDMI HLG	HLG View Assist (→ [HLG View Assist]: 495)
RAW+  	Picture quality (→ [Picture Quality]: 127), Picture size (→ [Picture Size]: 125)
  	Crop Zoom (Photo) (→ [Crop Zoom(Photo)]: 224)
CrZ	Crop Zoom (Video) (→ [Crop Zoom(Video)]: 228)
	Recording file format (→ [Rec. File Format]: 140)/ Recording quality (→ [Rec Quality]: 142)
MOV 4K 420/10-L	Recording file format (→ [Rec. File Format]: 140)/ Recording quality (→ [Rec Quality]: 142)
59.94p 60/59.94p	Recording frame rate (→ [Rec Quality]: 142)/ Variable frame rate (→ Variable Frame Rate: 465)
	Electronic shutter (→ [Shutter Type]: 283)
AFS AFC MF	Focus mode (→ Selecting the Focus Mode: 169 , Record Using MF: 215)
AFS  AFC 	Focus Limiter (→ [Focus Limiter]: 181)
	Focus Bracket (→ [More Settings] (Focus Bracket): 275)
AFL	AF Lock (→ Locking Focus and Exposure (AF/AE Lock): 326)

MFL	Focus ring lock (→ [Focus Ring Lock]: 636)
	Focus Peaking (→ [Focus Peaking]: 220)
FULL <small>PIXEL PIXEL</small>	Image area of video (→ [Image Area of Video]: 166)
	AF mode (→ Selecting the AF Mode: 189)
	AF detection setting (→ Automatic Detection: 192)
	Drive mode (→ Selecting the Drive Mode: 234)
	Connected to Wi-Fi (→ Checking operation of the Wi-Fi and Bluetooth functions: 715)
	Connected to Bluetooth (→ Connecting to a Smartphone (Bluetooth Connection): 734)
GPS	Location logging (→ [Location Logging]: 762)
	Image stabilizer (→ Image Stabilizer: 292)
	Camera shake alert (→ Using the Image Stabilizer: 294)





(2)

	Self-timer (→ Recording Using the Self-timer: 265)
	Silent mode (→ [Silent Mode]: 281)
	Proxy Recording (→ Proxy Recording: 161)
	Image area of video (→ [Image Area of Video]: 166)
	Anamorphic Desqueeze Display (→ [Anamorphic Desqueeze Display]: 498)
LC	Live View Composite recording (→ [Live View Composite]: 277)
	Overlay indication (→ [Sheer Overlay]: 654)
	LUT View Assist (→ [Log View Assist]: 490)
	Loop recording (→ [Loop Recording (video)]: 502)
	Streaming function is ON (→ Streaming Function: 796)
	Currently streaming (→ Streaming Function: 796)







(3)

	Built-in microphone, External microphone (→ [Sound Rec Level Disp.: 414, External Microphones (Optional): 424])
96kHz/24bit 	Sound recording quality/XLR microphone adaptor setting (→ [Sound Rec Quality]: 418, XLR Microphone Adaptor (Optional): 429)
4ch/96kHz/24bit	4ch audio recording (→ [4ch Audio Recording]: 432)
	Sound recording level limiter (→ [Sound Rec Level Limiter]: 420)
	Mute (→ [Mute Sound Input]: 415)
Sound recording level (→ [Sound Rec Level Disp.]: 414)	
Exposure meter (→ [Expo.Meter]: 653)	

(4)

	Histogram (→ [Histogram]: 648)
	AF area (→ AF Area Operations: 206)
+	Spot metering target (→ [Metering Mode]: 303)
+	Center marker (→ [Center Marker]: 659)
	Self-timer (→ Recording Using the Self-timer: 265)
	Lock lever (→ Operation Lock Lever: 89)
24m59s	Elapsed recording time (→ Basic Video Operations: 130)
TC 00:00:00:00	Time code (→ Time Code: 437)
	Image being sent (→ [Auto Transfer]: 759)



(5)

	Focus (turns green) (→ Basic Picture Operations: 121)/ Recording state (turns red) (→ High Resolution mode: 247 , Basic Video Operations: 130)
LOW 	Focus (in low light AF situations) (→ Low illumination AF: 173)
STAR 	Focus (Starlight AF) (→ Starlight AF: 173)
	Flash adjustment (→ [Flash Adjust.]: 383)
iA P A S M  P  P	Recording mode (→ Selecting the Recording Mode: 82)
	Program Shift (→ Program Shift: 307)









	Metering mode (→ [Metering Mode]: 303)
AEL	AE Lock (→ Locking Focus and Exposure (AF/AE Lock): 326)
60	Shutter speed (→ Basic Picture Operations: 121)
F2.8	Aperture value (→ Basic Picture Operations: 121)
^{BKT} F2.8	Aperture Bracket (→ [More Settings] (Aperture Bracket): 274)
^{BKT} 	Exposure compensation value (→ Exposure Compensation: 322)
	Exposure Bracket (→ [More Settings] (Exposure Bracket): 273)
	Manual Exposure Assist (→ Manual Exposure Assist: 317)
iso100	ISO sensitivity (→ ISO Sensitivity: 328)
	Card/external SSD access indication (turns red) (→ Basic Video Operations: 130 , Using an External SSD (Commercially Available): 541)
	Card slot (→ Inserting Cards (Optional): 63)/ Double card slot function (→ [Double Card Slot Function]: 670)/ External SSD (→ Using an External SSD (Commercially Available): 541)
	No card/external SSD
	Card/external SSD full







999	Number of pictures that can be taken (→ Number of Pictures That Can Be Taken and Video Recording Time According to Recording Media: 907)
r20	Number of pictures that can be taken continuously (→ Number of Pictures That Can Be Taken Continuously: 242)
24m59s	Video recording time (→ Video Recording Time: 909)
	Battery indication (→ Power Indications: 58)
	Power supply (→ Using the Camera While Supplying It with Power (Supplying Power/Charging): 56)

(6)

	Temperature rise warning icon (→ Recording: 877)
	Fan error warning icon (→ Others: 889)
A001C001	Video file name (when [CINE Style] is set) (→ [Video File Name]: 672)

Touch Tab (→[\[Touch Settings\]: 640](#))

	
	Fn button (→ Use [Fn4] to [Fn8] (Touch Icons): 611)
	
	Touch Zoom (→ Operations During Video Recording: 398)/ Crop Zoom (Photo) (→ [Crop Zoom(Photo)]: 224)/ Crop Zoom (Video) (→ [Crop Zoom(Video)]: 228)
	Touch AF, Touch Shutter (→ Touch AF/Touch Shutter: 115)
	Exposure compensation (→ Exposure Compensation: 322)
	Touch AE (→ Touch AE: 118)
	Focus Peaking (→ [Focus Peaking]: 220)

 (→ Setting a Filter with Touch Operation: 359)/  (→ Operations During Video Recording: 398)	
	Filter effect adjustment (→ Adjusting the Filter Effect: 358)
	Filter on/off (→ Setting a Filter with Touch Operation: 359)
EXPS	Filter setting (→ [Filter Settings]: 356)
	Zoom (→ Operations During Video Recording: 398)
F	Aperture value (→ Operations During Video Recording: 398)
SS	Shutter speed (→ Operations During Video Recording: 398)
	Exposure compensation (→ Operations During Video Recording: 398)
ISO	ISO sensitivity (→ Operations During Video Recording: 398)
	Sound recording level adjustment (→ Operations During Video Recording: 398)

❖ Control Panel









(1)

	Recording mode (→ Selecting the Recording Mode: 82)
1/60	Shutter speed (→ Basic Picture Operations: 121)
F2.8	Aperture value (→ Basic Picture Operations: 121)
 	Battery indication (→ Power Indications: 58)/ Power supply (→ Using the Camera While Supplying It with Power (Supplying Power/Charging): 56)





(2)

	ISO sensitivity (→ ISO Sensitivity: 328)
	Exposure compensation value (→ Exposure Compensation: 322)/ Manual Exposure Assist (→ Manual Exposure Assist: 317)
 	Flash setting (→ [Flash Adjust.]: 383 , [Flash Synchro]: 384 , Recording Using a Wireless Flash: 386)/ Flash mode (→ [Flash Mode]: 378)

(3)

	Drive mode (→ Selecting the Drive Mode: 234)
AFS	Focus mode (→ Selecting the Focus Mode: 169 , Record Using MF: 215)
	AF mode (→ Selecting the AF Mode: 189)
FINE	Picture quality (→ [Picture Quality]: 127)
	Image area of video (→ [Image Area of Video]: 166)/ Recording file format (→ [Rec. File Format]: 140)/ Recording quality (→ [Rec Quality]: 142)
4:3 	Picture size/Aspect ratio (→ [Picture Size]: 125)
	Wi-Fi/Bluetooth connection state (→ Checking operation of the Wi-Fi and Bluetooth functions: 715)
Fn 	Fn button settings (→ Fn Buttons: 597)

(4)

 STD.	Photo Style (→ [Photo Style]: 342)
AWB	White balance (→ White Balance (WB): 334)
 OFF	i.Dynamic Range (→ [i.Dynamic Range]: 325)
	Metering mode (→ [Metering Mode]: 303)
	Card slot (→ Inserting Cards (Optional): 63)/ Double card slot function (→ [Double Card Slot Function]: 670)/ External SSD (→ Using an External SSD (Commercially Available): 541)
	No card/external SSD
	Card/external SSD full
999	Number of pictures that can be taken (→ Number of Pictures That Can Be Taken and Video Recording Time According to Recording Media: 907)
r20	Number of pictures that can be taken continuously (→ Number of Pictures That Can Be Taken Continuously: 242)
R24m59s	Video recording time (→ Video Recording Time: 909)
----	No card

❖ Control Panel (Creative Video Mode)

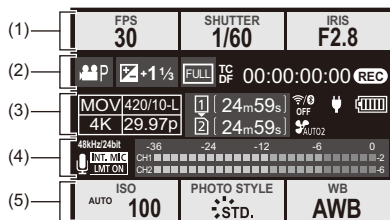









(1)

FPS 60	Frame rate (→ [Rec Quality]: 142/ Variable frame rate (→ Variable Frame Rate: 465)
SHUTTER 1/60	Shutter speed (→ Shutter-Priority AE Mode: 312)
IRIS F2.8	Aperture value (→ Aperture-Priority AE Mode: 309)

(2)

	Exposure mode (→ Setting the Exposure for Recording Videos: 396)
	Exposure compensation value (→ Exposure Compensation: 322/
	Manual Exposure Assist (→ Manual Exposure Assist: 317)
	Image area of video (→ [Image Area of Video]: 166)
TC DF 00:00:00:00	Time code (→ Time Code: 437)
	Recording state (→ Screen Displays While Video Recording: 132)

(3)

	<p>Recording file format (→[Rec. File Format]: 140)/ Recording quality (→[Rec Quality]: 142)</p>
	<p>Card slot (→Inserting Cards (Optional): 63)/ Double card slot function (→[Double Card Slot Function]: 670)/ External SSD (→Using an External SSD (Commercially Available): 541)</p>
<p>24m59s</p>	<p>Video recording time (→Video Recording Time: 909)</p>
 A001 C001	<p>Wi-Fi/Bluetooth connection state (→Checking operation of the Wi-Fi and Bluetooth functions: 715) Video file name (when [CINE Style] is set) (→[Video File Name]: 672)</p>
	<p>Fan operating mode (→[Fan Mode]: 663)</p>
	<p>Streaming function is ON (→Streaming Function: 796)</p>
	<p>Currently streaming (→Streaming Function: 796)</p>
 	<p>Battery indication (→Power Indications: 58)/ Power supply (→Using the Camera While Supplying It with Power (Supplying Power/Charging): 56)</p>

(4)

<p>INT.MIC EXT.MIC</p> <p>96kHz/24bit XLR</p> <p>4ch/96kHz/24bit</p>	<p>Built-in microphone, External microphone (→[Sound Rec Level Disp.]: 414, External Microphones (Optional): 424)</p> <p>Sound recording quality/XLR microphone adaptor setting (→[Sound Rec Quality]: 418, XLR Microphone Adaptor (Optional): 429)</p> <p>4ch audio recording (→[4ch Audio Recording]: 432)</p>
<p>LMT ON LMT OFF</p>	<p>Sound recording level limiter (→[Sound Rec Level Limiter]: 420)</p>
	<p>Mute (→[Mute Sound Input]: 415)</p>
<p>Sound recording level (→[Sound Rec Level Disp.]: 414)</p>	

(5)

<p>ISO AUTO 100</p>	<p>ISO sensitivity (→ISO Sensitivity: 328)</p>
<p>PHOTO STYLE STD.</p> <p>MON LUT HDMI WLog</p> <p>MON MODE2 HDMI HLG</p>	<p>Photo Style (→[Photo Style]: 342)/ LUT View Assist (→[Log View Assist]: 490)/ HLG View Assist (→[HLG View Assist]: 495)</p>
<p>WB AWB</p>	<p>White balance (→White Balance (WB): 334)</p>

❖ Audio Information Display

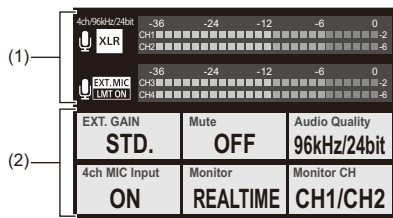

(1)



<input type="checkbox"/> INT. MIC <input checked="" type="checkbox"/> EXT. MIC	Built-in microphone, External microphone (→[Sound Rec Level Disp.]: 414, External Microphones (Optional) : 424)
96kHz/24bit <input checked="" type="checkbox"/> XLR	Sound recording quality/XLR microphone adaptor setting (→[Sound Rec Quality]: 418, XLR Microphone Adaptor (Optional) : 429)
4ch/96kHz/24bit	4ch audio recording (→[4ch Audio Recording]: 432)
<input type="checkbox"/> LMT ON <input checked="" type="checkbox"/> LMT OFF	Sound recording level limiter (→[Sound Rec Level Limiter]: 420)
<input checked="" type="checkbox"/> Mute	Mute (→[Mute Sound Input]: 415)
Sound recording level (→[Sound Rec Level Disp.]: 414)	

(2)

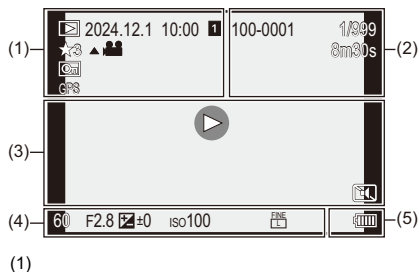

EXT.GAIN STD.	Sound recording gain switch (→[Sound Rec Gain Level]: 416)
Mute OFF	Sound input mute (→[Mute Sound Input]: 415)
Audio Quality 96kHz/24bit	Sound recording quality (→[Sound Rec Quality]: 418)
4ch MIC Input ON	4ch audio recording (→[4ch Audio Recording]: 432)
Monitor REALTIME	Sound monitoring (→[Headphones]: 433)
Monitor CH CH1/CH2	Sound monitoring channel (→[Sound Monitoring Channel]: 435)

Playback Screen



	Playback mode (→ [Playback Mode]: 585)
2024.12. 1 10:00	Recording date and time (→ Setting the Clock (When Turning On for the First Time): 75)
 	Card slot (→ Switching the Card to Display: 551)/ External SSD (→ Using an External SSD (Commercially Available): 541)
★3	Rating (→ [Rating]: 589)
	Video playback (→ Playing Back Videos: 552)
	Protected picture (→ [Protect]: 589)
GPS	Location logging (→ [Location Logging]: 762)
	Proxy recording (original video/proxy video) (→ Proxy Recording: 161)
	Obtaining information

(2)

100-0001 A001C001	Folder/file number (→ [Folder / File Settings]: 675)/ Video file name (when [CINE Style] is set) (→ [Video File Name]: 672)
1/999	Image number/Total number of images
9 pic. 9 files	Number of group images/ Number of files
8m30s	Video recording time (→ Playing Back Videos: 552)
▶ XXmXXs 📺 XXs	Variable frame rate (→ Variable Frame Rate: 465)
↻ XXmXXs	Loop recording (→ [Loop Recording (video)]: 502)
	LUT View Assist (→ [Log View Assist]: 490)
	HLG View Assist (→ [HLG View Assist]: 495)



(3)

	Playback (video) (→ Playing Back Videos: 552)
	Group images (→ Group Images: 567)
TC 00:00:00:00	Time code (→ Time Code: 437)
96kHz/24bit	Sound recording quality (→ [Sound Rec Quality]: 418)
MOV 4K 420/10-L	Recording file format (→ [Rec. File Format]: 140)/ Recording quality (→ [Rec Quality]: 142)
59.94p 60/59.94p	Frame rate (→ [Rec Quality]: 142)/ Variable frame rate (→ Variable Frame Rate: 465)
FULL <small>PIXEL</small> <small>PIXEL</small>	Image area of video (→ [Image Area of Video]: 166)
	Wi-Fi/Bluetooth connection state (→ Checking operation of the Wi-Fi and Bluetooth functions: 715)
	Silent mode (→ [Silent Mode]: 281)

(4)

Recording information

(5)

	Battery indication (→ Power Indications: 58)
	Power supply (→ Using the Camera While Supplying It with Power (Supplying Power/Charging): 56)

Detailed information display

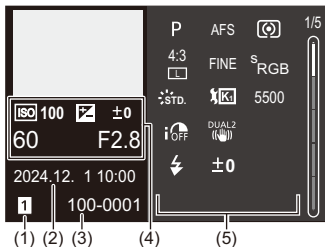

- (1) Card slot (→ [Inserting Cards \(Optional\): 63](#))/External SSD (→ [Using an External SSD \(Commercially Available\): 541](#))
- (2) Recording date and time (→ [Setting the Clock \(When Turning On for the First Time\): 75](#))
- (3) Folder/file number (→ [\[Folder / File Settings\]: 675](#))/Video file name (when [CINE Style] is set) (→ [\[Video File Name\]: 672](#))
- (4) Recording information (basic)
- (5) Recording information (advanced)

Histogram display

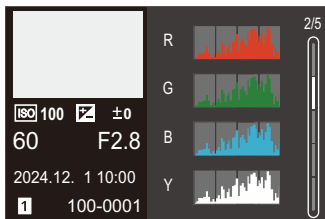

Photo Style display

ISO 100 ± 0
 60 F2.8
 2024.12. 1 10:00
 1 100-0001

Standard 3/5
 Contrast ± 0
 Highlight ± 0
 Shadow ± 0
 Saturation ± 0
 Hue ± 0
 Sharpness ± 0
 Noise Reduction ± 0

White balance display

ISO 100 ± 0
 60 F2.8
 2024.12. 1 10:00
 1 100-0001

5500K 4/5
 G
 A B
 M

Lens information display

ISO 100 ± 0
 60 F2.8
 2024.12. 1 10:00
 1 100-0001

LEICA DG 12-60/F2.8-4. 5/5
 0
 Focal Length 12mm
 35mm Focal Length 24mm
 Vignetting Comp. OFF
 Long Exposure NR OFF

Message Displays

Meanings of main messages displayed on the camera screen, and response methods.

❖ Card

[Memory Card Error]/[Format this card?]

- It is a format that cannot be used with the camera.
Either insert another card, or back up any necessary data before formatting.
(→[\[Card Format\]: 669](#))

[Memory Card Error]/[This memory card cannot be used]

- Use a card compatible with the camera. (→[Memory Cards That Can Be Used: 26](#))

[Insert memory card again.]/[Try another card]

- Unable to access the card. Reinsert the card.
- Insert a different card.

[Read Error]/[Write Error]/[Please check the card]

- Failure to read or write data.
Turn off the camera, reinsert the card, and then turn it on again.
- The card may be broken.
- Insert a different card.

[Recording was cancelled due to the limitation of the writing speed of the card]

- The card does not meet the writing speed requirements for recording.
Cards that can be used depend on the video image quality. Check whether the card you are using meets the conditions required for recording. (→[SD Cards That Can Be Used with This Camera: 27](#))
 - * Check with the card manufacturers for the specifications of their cards.
- If recording stops even if you are using a card that meets the conditions required for recording, it is possible that the speed of writing on the card has dropped.
Take a backup of the data, and either format the card (SD cards) or low level format the card (CFexpress cards). (→[\[Card Format\]: 669](#))
- When using CFexpress cards, the writing speed can drop if the temperature of the card rises. Wait until the card cools down.

❖ Lens

[The lens is not attached properly. Do not push lens release button while lens is attached.]

- Remove the lens once, and then attach it again without pressing the lens release button. (→ [Attaching a Lens: 67](#))
Turn on the camera again, and if it is still displaying, contact the dealer.

[Lens attachment failed. Please make sure the lens is attached correctly.]

- Remove the lens from the camera body and gently wipe the contacts on the lens and the camera body using a dry cotton swab.
Attach the lens, turn on the camera again, and if it is still displaying, contact the dealer.

❖ Battery

[This battery cannot be used]

- Use a genuine Panasonic battery.
If this message is displayed even when a genuine Panasonic battery is used, contact the dealer.
- If the terminal of the battery is dirty, remove the dirt and dust from the terminal.

[The life span of this battery is starting to decline and should be considered for replacement. To maintain reliability refrain from using this battery.]

- The battery has deteriorated. Try not to use that battery.

❖ Others

[Some pictures cannot be deleted]/[This picture cannot be deleted]

- Images that do not comply with the DCF standard cannot be deleted.
Back up any necessary data before formatting the card. (→[\[Card Format\]: 669](#))

[A folder cannot be created]

- The maximum number of folder numbers has been reached, so new folders cannot be created.

When [Video File Name] is set to [Same As Photo(DCF Standard)]:

After formatting the card, execute [File Number Reset] in the [Setup] ([Card/File]) menu. (→[\[File Number Reset\]: 677](#))

When [Video File Name] is set to [CINE Style]:

Format the card. (→[\[Card Format\]: 669](#))

[Please turn camera off and then on again]/[System Error]

- Turn off and on the camera.
If the message is displayed even when doing this several times, contact the dealer.

[The fan is not functioning correctly.]

- The fan has stopped. Turn off and on the camera. If the fan does not work after turning the camera off and then on again, consult the dealer.
- The temperature of the camera will rise if you continue to use the camera with the fan stopped. Do not use over long periods of time.

Troubleshooting

- [Power, Battery: 876](#)
- [Recording: 877](#)
- [Video: 882](#)
- [Playback: 883](#)
- [Monitor/Viewfinder: 884](#)
- [Flash: 884](#)
- [Wi-Fi Function: 885](#)
- [TV, PC: 888](#)
- [Others: 889](#)

First, try out the following procedures.

If the problem is not resolved, it may be improved by selecting [Reset] (→ [\[Reset\]: 107](#)) on the [Setup] ([Setting]) menu.

Power, Battery

The camera turns off automatically.

- [Power Save Mode] is enabled. (→[Power Save Mode]: 60)

The battery becomes flat too quickly.

- When connected to Wi-Fi, the battery drains quickly.
Turn the camera off frequently such as by using [Power Save Mode] (→[Power Save Mode]: 60).
- When [Continuous AF] is set to [MODE2], the battery drains faster. Battery consumption can be reduced by setting to [MODE1] or [OFF]. (→[Continuous AF]: 402)
- When the following functions are being used, power is supplied from the battery of this camera to the connected device, so the battery will be consumed faster:
 - [USB-SSD]
 - [Streaming] (when [Connection Method] in [Streaming] is set to [USB Tethering]/[LAN])
 - [Tether(USB ethernet adaptor)] in [USB]When not using these functions, set them to [OFF]. (→Using an External SSD (Commercially Available): 541, Streaming Function: 796, Tethered Recording: 833)

Recording

Recording stops before finishing. Cannot record. Cannot use some functions.

- The temperature of the camera rises more readily in the following circumstances: when the ambient temperature is high, during continuous use such as when recording high-definition video or outputting via HDMI. When the temperature of the camera rises, [] appears blinking on the screen. If you continue to use the camera, a message indicating that the camera cannot be used is displayed on the screen and some functions, such as recording and HDMI output, will be stopped. Wait for the camera to cool down and for the message indicating that the camera can be used again. When the message indicating that it can be used again is displayed, turn the camera off then on again.
 - * When recording with the camera mounted on a tripod, etc., you can set the temperature at which recording is stopped to a higher temperature. (→[\[Thermal Management\]: 679](#))

Cannot record images. The shutter will not operate immediately when the shutter button is pressed.

- If [Focus/Shutter Priority] is set to [FOCUS], then recording will not take place until focus is achieved. (→[\[Focus/Shutter Priority\]: 634](#))

The recorded image is whitish.

- Images may look whitish when the lens or image sensor gets dirty with fingerprints or similar.

If the lens is dirty, turn the camera off, then wipe the lens surface with a soft, dry cloth.

For information about how to clean the image sensor (→[Dirt on the Image Sensor: 893](#))

The recorded image is too bright or dark.

- Ensure AE Lock is not set where it is not appropriate. (→ [Locking Focus and Exposure \(AF/AE Lock\): 326](#))

Multiple images are recorded at once.

- When drive mode is set to [**I**] (Burst Shot 1) or [**II**] (Burst Shot 2), pressing and holding the shutter button will take burst pictures. (→ [Selecting the Drive Mode: 234](#))
- When [Bracketing] is set, then pressing the shutter button records multiple images while automatically changing the settings. (→ [Bracket Recording: 269](#))

The subject is not focused properly.

- Confirm the following details:
 - Is the subject outside of the focus range?
 - Is [Shutter AF] set to [OFF]? (→ [\[Shutter AF\]: 637](#))
 - Is [Focus/Shutter Priority] set to [RELEASE]? (→ [\[Focus/Shutter Priority\]: 634](#))
 - Is AF Lock (→ [Locking Focus and Exposure \(AF/AE Lock\): 326](#)) set where it is not appropriate?
 - Is [Focus Limiter] set to [ON]? (→ [\[Focus Limiter\]: 181](#))
 - Is [AF Micro Adjustment] set? (→ [\[AF Micro Adjustment\]: 185](#))

Cannot focus or zoom with the lens.

- Confirm the following details:
 - Is "Lens" in [Lock Lever Setting] set to [**L**]? (→ [\[Lock Lever Setting\]: 641](#))
 - Is [Focus Ring Lock] set to [ON]? (→ [\[Focus Ring Lock\]: 636](#))

The recorded image is blurred. The image stabilizer is not effective.

- The shutter speed will become slower and the image stabilizer function may not work properly when recording in dark places.
In these cases, use a tripod and the self-timer when recording.

The recorded image looks rough. Noise appears on the picture.

- Try the following:
 - Reduce the ISO sensitivity. (→ [ISO Sensitivity: 328](#))
 - Increase [Noise Reduction] of [Photo Style] to the positive direction, or adjust each item other than [Noise Reduction] to the negative direction. (→ [Adjusting Image Quality: 348](#))
 - Set [Long Exposure NR] to [ON]. (→ [Long Exposure NR: 287](#))
- When the camera is used continuously, the temperature inside the camera may rise and this may cause lower image quality. We recommend turning off the camera whenever you are not actually recording.

The subject appears distorted on the image.

- When a moving subject is recorded while using the following functions, the subject may appear distorted in the picture:
 - [ELEC.]
 - Video recording

This is a characteristic of the CMOS sensor that is the image sensor of the camera, and is not a malfunction.

Striping or flicker may appear under lighting such as fluorescent or LED lighting.



- This is characteristic of CMOS sensors which serve as the camera's pickup sensors. This is not a malfunction.
- When using the electronic shutter (→ [\[Shutter Type\]: 283](#)), lowering the shutter speed may reduce the effect of the horizontal stripes.
- If flicker or horizontal stripes are noticeable when recording video, this can be mitigated by fixing the shutter speed. Either set [\[Flicker Decrease \(Video\)\]](#) (→ [\[Flicker Decrease \(Video\)\]: 449](#)), or fix the shutter speed with the [\[M\]](#) mode (→ [Recording Modes Specifically for Video \(Creative Video\): 394](#)).
- You can make finer adjustments to shutter speed by using [\[Synchro Scan\(Photo\)\]](#) or [\[Synchro Scan\(Video\)\]](#). (→ [\[Synchro Scan\(Photo\)\]: 288](#), [\[Synchro Scan\(Video\)\]: 500](#))

Stripes appear in high ISO sensitivity.

- Stripes may appear in high ISO sensitivity or depending on the lens you use. Decrease the ISO sensitivity. (→ [ISO Sensitivity: 328](#))

The brightness or coloring of the recorded image is different from the actual scene.

- When recording under lighting such as fluorescent or LED lighting, increasing the shutter speed may introduce slight changes to brightness or coloring. These are a result of the characteristics of the light source and do not indicate a malfunction.
- When recording subjects in extremely bright locations or recording under lighting such as fluorescent, LED, mercury, or sodium lighting, the coloring or screen brightness may change or horizontal striping may appear on the screen.

Bright spot not in subject is recorded.

- Pixels may be missing from the image sensor.
Perform [Pixel Refresh]. (→[\[Pixel Refresh\]: 694](#))

Video

Cannot record videos.

- Try again after either returning the [System Frequency] to the original setting or inserting another card.
- When using a large capacity card, you may not be able to record for a while after turning on the camera.
- There are [Rec. File Format] and [Rec Quality] that cannot be recorded to SD cards. Use CFexpress cards. (→[Memory Cards That Can Be Used: 26](#))

In videos, abnormal clicking and buzzing sounds are recorded.

The recorded audio is very quiet.

- Depending on the recording conditions or the lens used, the sound of aperture and focus actions may be recorded in videos.
You can set the focus operation during video recording to [OFF] in [Continuous AF] (→[\[Continuous AF\]: 402](#)).
- Do not block the microphone hole during video recording.

An operation sound is recorded in a video.

- We recommend setting the [pCM] mode and recording with touch operation if you are bothered about the operation sounds during recording. (→[Operations During Video Recording: 398](#))

Playback

Cannot play back. There are no recorded pictures.

- Folders and images processed on a PC cannot be played on the camera.
- Some images are not displayed when the [Playback Mode] is set. Set to [Normal Play]. (→[Playback Mode]: 585)
- Videos recorded with a different [System Frequency] setting cannot be played back. Return the [System Frequency] setting to the one you used during the recording. (→[System Frequency]: 138)

Monitor/Viewfinder

The monitor/viewfinder turns off when the camera is turned on.

- If no operations are performed during the set time period, [Auto LVF/Monitor Off] (→[Auto LVF/Monitor Off]: 61) is activated, and the monitor/viewfinder turns off.
- When an object or your hand is positioned near the eye sensor, the monitor display may switch to the viewfinder display.

It may flicker for an instant or the brightness of the screen may change significantly for an instant.

- This occurs when the shutter button is pressed halfway, or when the subject brightness changes, making the lens aperture change.
This is not a malfunction.

Unevenly bright parts or irregular colors appear on the viewfinder.

- The viewfinder of the camera is built with OLED components. Screen burn-in may occur on the screen/viewfinder when a same image is displayed for a long period of time, but it does not affect the recorded images.

Flash

The flash does not fire.

- The flash does not fire when using the following functions:
 - Video recording
 - [ELEC.]/[Silent Mode]
 - High Resolution mode
 - [Filter Settings]

Wi-Fi Function

A Wi-Fi connection cannot be established. Radio waves get disconnected. Wireless access point is not displayed.

General tips for using a Wi-Fi connection

- Use within the communication range of the device to be connected.
- Usage near devices that utilize the 2.4 GHz frequency such as microwave ovens and cordless telephones may result in the radio wave being lost.
Use the camera at a sufficient distance from these devices.
- When the remaining battery level is low, it may not be possible to connect to or maintain communication with other devices.
(A message such as [Communication error] is displayed.)
- If you place the camera on a metal table or shelf, the radio waves may be adversely affected. In such cases, you may not be able to establish a connection.
Move the camera away from the metal surface.

Wireless access point

- Confirm that the connected wireless access point can be used.
- Confirm the radio wave conditions of the wireless access point.
 - Move the camera closer to the wireless access point.
 - Change the location and angle of the wireless access point.
- Depending on the wireless access point, the radio wave may not be displayed even though it is present.
 - Turn off and then on the wireless access point.
 - If the wireless channel of the wireless access point cannot be set automatically, manually set the channel supported by the camera.
 - If the wireless access point SSID is set not to broadcast, it may not be detected.
Enter the SSID, and then connect. (→ [Connecting by Manual Input: 776](#))
- Depending on the wireless access point, connection may be automatically disconnected after specific time has passed.
Reconnect the connection again.

Cannot connect with a wireless access point.

- The wireless access point information set on the camera is wrong.
Check the authentication type and encryption key. (→ [Connecting by Manual Input: 776](#))
- Radio waves from other devices may block the connection to a wireless access point.
Check the status of other devices that are connected to the wireless access point as well as the status of other wireless devices.

Wi-Fi connection on an iOS device fails.

- Follow the message displayed to allow connection to the camera.
If you still cannot connect, select the SSID of the camera on the Wi-Fi setup screen of the smartphone to connect.
If the SSID is not displayed, turn off and on the camera, then perform the Bluetooth connection settings again.

Wi-Fi connection with a smartphone is not possible.

- Change the access point to connect to in the smartphone Wi-Fi settings to the camera.

When trying to connect to a PC by Wi-Fi, this does not recognize the user name and password, and connection is not possible.

- Depending on the version of the OS, there are two types of user account (local account/Microsoft account).
Ensure you use the local account user name and password.

The PC is not recognized when I use a Wi-Fi connection. The camera cannot be connected to the PC using the Wi-Fi function.

- At the time of purchase, this camera is set to use a workgroup name of "WORKGROUP".
If you have changed the workgroup name of the PC, this will not be recognized. In the [LAN / Wi-Fi Setup] menu, [PC Connection], change the workgroup name of the PC to which to connect. (→[PC Connection]: 785)
- Check that the login name and password are correctly typed.
- When the clock settings of the PC connected to the camera differs considerably from those of the camera, the camera cannot be connected to the PC depending on the OS.

Sending of videos/images fails midway. There are some videos/images that cannot be sent.

- Is the size of the image too large?
 - Reduce the image size at [Size] (→[Size]: 782), and then send.
 - Transmit after dividing the video with [Video Divide] (→[Video Divide]: 559).
- File format of the video that can be sent differs depending on the destination. (→[Images That Can be Sent: 771])
- If sending of videos/images fails, we recommend transferring them over a USB connection cable.

I have forgotten the password for the Wi-Fi.

- In the [Setup] ([Setting]) menu, [Reset], reset network settings. (→[Reset]: 107)
However, all information set in [LAN / Wi-Fi Setup] and [Bluetooth] will also be reset.

TV, PC

The TV images are displayed with gray bands.

- Depending on the [Aspect Ratio], gray bands may be displayed on the top and bottom or the left and right of the images. You can change the band color in [Background Color(Playback)] in [HDMI Connection] of the [Setup] ([IN/OUT]) menu. (→[Background Color(Playback)]: 689)

Images cannot be imported even when connected to a PC.

- Set the [USB Mode] of the camera to [PC(Storage)]. (→[USB Mode]: 687)
- Turn the camera off and on.

Others

is displayed on the screen.

- The fan has stopped. Turn off and on the camera. If the fan does not work after turning the camera off and then on again, consult the dealer.
- The temperature of the camera will rise if you continue to use the camera with the fan stopped. Do not use over long periods of time.

An alarm sounds when the card door is opened.

- An alarm may sound when a door is opened while writing to a card. Wait until writing finishes, then turn the camera off and remove the card.

When the camera is shaken, a rattling sound is heard from the camera.





- The sound is caused by the in-body stabilizer. This is not a malfunction.

There is rattling noise from the lens when the camera is turned on or off, or when the camera is swung. There is a sound from the lens when recording.

- This is the sound of the internal lenses moving or the aperture operating. It is not a malfunction.

An unreadable language was selected by mistake.

- Reselect the language from the menu using the following procedure:

 ⇒ [] ⇒ [] ⇒ [] ⇒ Select desired language (⇒ [\[Language\]: 695](#))

The camera becomes warm.

- The camera surface and back of the monitor may become warm during use, but this does not indicate a problem with performance or quality.

Cautions for Use

❖ The Camera

Keep this unit as far away as possible from electromagnetic equipment (such as microwave ovens, TVs, video games etc.).

- If you use this unit on top of or near a TV, the pictures and/or sound on this unit may be disrupted by electromagnetic wave radiation.
- Do not use this unit near cell phones because doing so may result in noise adversely affecting the pictures and/or sound.
- Recorded data may be damaged, or pictures may be distorted, by strong magnetic fields created by speakers or large motors.
- Electromagnetic wave radiation may adversely affect this unit, disturbing the pictures and/or sound.
- If this unit is adversely affected by electromagnetic equipment and stops functioning properly, turn this unit off and remove the battery or disconnect AC adaptor. Then reinsert the battery or reconnect AC adaptor and turn this unit on.

Do not use this unit near radio transmitters or high-voltage lines.

- If you record near radio transmitters or high-voltage lines, the recorded pictures and/or sound may be adversely affected.

Do not extend the cords or the cables.

Keep items away from the magnetic parts (A)/(B)/(C) that are easily influenced by magnetism.

The effects of the magnets may cause items like bank cards, commuter cards, and clocks to cease functioning correctly.

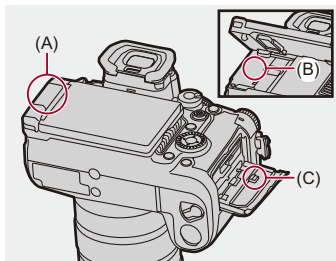

Do not spray the camera with insecticides or volatile chemicals.

- If the camera is sprayed with such chemicals, the body of the camera may be damaged and the surface finish may peel off.

Do not keep products made of rubber, PVC or similar materials in contact with the camera for a long period of time.

❖ When Using in Cold Places or at Low Temperatures

- **Skin burns may result if you leave the metal parts of the camera in direct contact with the skin for long periods of time at cold places (environments with temperatures at or below 0 °C (32 °F), such as ski resorts or places at high altitude).**

Use gloves or similar when using it for long periods.

- The performance of the battery (Number of pictures that can be taken/available recording time) may decrease temporarily at temperatures between -10 °C and 0 °C (14 °F and 32 °F).

Keep the battery warm as you are using by keeping it inside your cold weather gear or clothes. Battery performance will recover when the internal temperature rises again.

- The battery cannot be charged at temperatures below 0 °C (32 °F).

An error message is shown on the charger or on the camera body when charging is not possible.

– When charging with the charger: The 50 % charged light blinks rapidly.

– When charging in the camera body: The charging light blinks red.

- If using in cold locations, do not allow water droplets and snow to remain on the camera.

If these are left on the camera, water may freeze in gaps in the camera on/off switch, speaker, and microphone, making these parts difficult to move, and/or leading to reduced volume. This is not a malfunction.

❖ Cleaning

Before cleaning the camera, remove the battery or the DC Coupler, and disconnect the power plug from the electrical outlet. Then wipe the camera with a dry, soft cloth.

- When the camera is soiled badly, it can be cleaned by wiping the dirt off with a wrung wet cloth, and then with a dry cloth.
- Do not use solvents such as benzine, thinners, alcohol, kitchen cleansers, etc., as there is a possibility that these can deform the surfaces of the camera, such as those of the external case and the mount, or cause peeling of the coatings.
- When using a chemical cloth, be sure to follow the accompanying instructions.

❖ Dirt on the Image Sensor

If dirt gets inside the mount when changing lenses, depending on the recording conditions, it may adhere to the image sensor and appear on the recorded picture.

To prevent debris or dust adhering to internal parts of the body, avoid changing the lens in a dusty environment and always fit the body cap or a lens when storing the camera.

Remove any dirt on the body cap before attaching it.

Dust reduction function

The camera has a dust reduction function that will blow off the dirt and dust that have affixed to the front of the image sensor.

If the dirt is particularly noticeable, from the [Setup] ([Others]) menu, perform [Sensor Cleaning]. (→[Sensor Cleaning]: 695)

Removing dirt on the image sensor

The image sensor is very precise and delicate, so be sure to observe the following when you do have to clean it yourself.

- Blow dust off the surface of the image sensor using a commercially available blower. Do not blow the dust off with excessive power.
- Do not put the blower further inside than the lens mount. The blower can scratch the image sensor if it touches.
- Do not use any objects except a blower brush to clean the image sensor.
- If you cannot remove the dirt or dust with the blower, consult the dealer or Panasonic.

❖ Cleaning the Viewfinder

If the viewfinder is dirty, then remove the eye cup and clean.

While pushing the eye cup lock lever (D), push the eye cup up in the direction of the arrow and remove (E).

Blow dirt off the surface of the viewfinder using a commercially available blower, then lightly wipe with a soft, dry cloth.

- After cleaning, fit by pushing the eye cup in the direction of the arrow until a click is heard (F).
- Be careful not to lose the eye cup.



❖ **Monitor/Viewfinder**

- Do not push hard on the monitor.
This may cause irregular coloration or malfunction.
- Extremely high precision technology is employed to produce the monitor/viewfinder screen. However there may be some dark or bright spots, or spots that light constantly (red, blue, or green) on the screen.

This is not a malfunction.

Though the monitor/viewfinder screen parts are produced with highly controlled precision technology, some pixels may be inactive or always lit.

The spots will not be recorded on images on a card.

❖ Lens

- **When using this lens, take care not to drop, bump, or apply undue force to it. Doing so may cause malfunction or damage to this lens and the digital camera.**
- Do not aim the lens at the sun or strong light sources.
The concentrated light may cause fire or damage.
- Do not allow strong light beams, such as laser light, to be directly exposed to this camera (lens). These can destroy the image sensor and cause the camera to malfunction.
- Images may be affected by dust, dirt, and soiling (water, oil, fingerprints, etc.) on the lens surface.
Before and after recording, use a blower to blow off dust and dirt from the surface of the lens, then lightly wipe with a soft dry cloth to remove soiling.
- When the camera is not being used, attach the lens cap and lens rear cap to prevent dust and dirt from adhering to or entering the camera.
- To protect the lens contact points (G), do not do the following.
These may cause a malfunction.
 - Touch the lens contact points.
 - Soil the lens contact points.
 - Place the lens with its mount surface facing down.

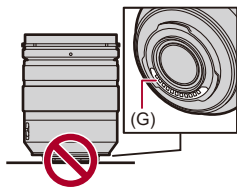

- To improve the dust and splash resistant performance of the interchangeable lens (H-ES12060/H-FS12060), a lens mount rubber is used in the mount.
 - The lens mount rubber will leave scuff marks on the digital camera mount, but this does not impact performance.
 - To replace the lens mount rubber, contact Panasonic.

❖ Battery

The battery is a rechargeable lithium ion battery.

It is highly sensitive to temperature and humidity, and the effect on performance increases as the temperature rises or drops.

Do not let the battery terminals (H) become soiled.

- Wipe with a dry cloth if they become soiled.

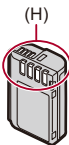

Always remove the battery after use.

- Place the removed battery in a plastic bag, etc., and keep away from metallic objects (clips, etc.) for storage or transport.

If you drop the battery accidentally, check to see if the body of the battery and the contacts are deformed.

- Damage to the camera will result if a battery with deformed contacts is inserted into the camera.

Dispose of unusable battery.

- The battery has a limited life.
- Do not throw the battery into fire because it may cause an explosion.

Do not allow battery terminals to come into contact with metal objects (such as necklaces, hairpins, etc.).

- This can cause short-circuiting or heat generation and you may be badly burned if you touch a battery.

❖ Charger

- The charging lights may blink under the influence of static electricity or electromagnetic wave, depending on the charging environment. This phenomenon has no effects on charging.
- Keep the contacts (I) of the charger and battery clean. Wipe them with a dry cloth if they get dirty.

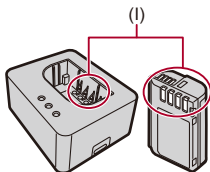

❖ Card

Do not leave the card in areas with high temperatures, direct sunlight, or areas prone to electromagnetic waves and static.

Do not bend or drop the card.

Do not subject the card to strong vibration.

- Otherwise, the card and recorded data may be damaged.
- Put the card in the card case or the storage bag after use and when storing or carrying the card.
- Do not allow dirt, water or other foreign objects to get into the contacts on the card. Additionally, do not touch the contacts with your hands.

Personal Information

Personal information is stored within the camera and in recorded images. We recommend that you enhance security by setting a Wi-Fi password and LAN / Wi-Fi function lock to protect personal information. (→ [\[LAN / Wi-Fi Setup\] Menu: 784](#))

- Images may contain information that can be used to identify the user, such as recording dates and times, and location information.

Disclaimer

- Information including personal information may be altered or vanish due to erroneous operation, effect of static electricity, accident, malfunction, repair, or other handlings.

Please note in advance that Panasonic is not liable in any way for any direct or indirect damage from the alteration or vanishing of information or personal information.

When requesting a repair or transferring/disposing of the camera

- After making a copy of personal information, be sure to delete information, including personal information, such as wireless LAN connection settings that you have registered or saved within the camera with [Reset] (→ [\[Reset\]: 107](#)).
- Reset the settings to protect the personal information. (→ [\[Reset\]: 107](#))
- Remove the card from the camera.
- Settings may return to factory default when camera is repaired.
- Please contact the dealer where you purchased the camera or Panasonic if above operations are not possible due to malfunction.

Points to remember when disposing of/transferring the memory card

Format or delete using the camera or a PC will only modify the file management information, so it will not delete the data in the card completely.

We recommend physically destroying the card or using commercially available PC data deletion software to delete the card data completely when disposing of/transferring the card.

You are responsible for handling of data on cards.

❖ When Not Using the Camera for a Long Period of Time

- Ensure you remove the battery and card from the camera.
If the battery is left in the camera, it may over-discharge, and be rendered unusable even after charging.
- Store the battery in a cool and dry place with a relatively stable temperature.
(Recommended temperature: 15 °C to 25 °C (59 °F to 77 °F); recommended humidity: 40 %RH to 60 %RH)
- If storing for a long period of time, it is recommended that the battery be charged once per year, fully drained in the camera, then removed from the camera and then stored again.
- We recommend storing the camera with a desiccant (silica gel) when you keep it in a closet or a cabinet.
- Check all the parts before recording when you have not used the camera for a long period of time.

❖ Image Data

- Recorded data may be damaged or lost if the camera breaks down due to inappropriate handling.
Panasonic will not be liable for any damage caused due to loss of recorded data.

❖ Tripod

- Make sure the tripod is stable when the camera is attached to it.
- When using a tripod, removal of the battery may not be possible.
- Care is required because tightening the screw excessively may damage the camera, or cause the rating label to come off.
- Depending on the type of tripod you are using, the lens may interfere with the tripod head if the lens you are using has a large diameter.

Attempting to tighten the tripod screws in this case may cause damage to the camera or the lens.

We recommend using the Tripod Adaptor (DMW-TA1: optional).

- Please also refer to the operating instructions for the tripod.

❖ Shoulder Strap

- If you attach a heavy interchangeable lens to the camera body, do not carry the camera by the shoulder strap.

Hold the camera and the lens when carrying them.

Wi-Fi Function

Use the camera as a wireless LAN device.

When using devices or computer systems that require more reliable security than wireless LAN devices, ensure that the appropriate measures are taken for safety designs and defects for the systems used.

Panasonic will not take any responsibility for any damage that arises when using the camera for any purpose other than as a wireless LAN device.

Use of the Wi-Fi function of the camera is presumed to be in countries where it is sold.

There is the risk that the camera violates the radio wave regulations if used in countries other than those where it is sold, and Panasonic takes no responsibility for any violations.

There is the risk that data sent and received via radio waves may be intercepted.

Please note that there is the risk that data sent and received via radio waves may be intercepted by a third party.

Do not use the camera in areas with magnetic fields, static electricity or interference.

- Do not use the camera in areas with magnetic fields, static electricity or interference, such as near microwave ovens.
These may cause the interruption of the radio waves.
- Using the camera near devices such as microwave ovens or cordless telephones that use the 2.4 GHz radio wave band may cause a decrease in performance in both devices.

Do not connect to the wireless network you are not authorized to use.

When using Wi-Fi, wireless networks (SSID) that you are not allowed to use may be displayed, but you should not connect to these as it may be viewed as unauthorized access.

Number of Pictures That Can Be Taken and Available Recording Time with the Battery

Listed below are the numbers of pictures that can be taken and the time lengths available for recording when the supplied battery is being used.

- The number of pictures that can be taken is according to the CIPA (Camera & Imaging Products Association) standards.
- Using a Nextorage CFexpress Type B card.
- Using a Nextorage SDXC memory card.
- Using a Samsung external SSD.
- The values listed are approximate.

❖ Recording Pictures (When Using the Monitor)

When the interchangeable lens (H-ES12060) is used

Recording media	Number of pictures that can be taken
CFexpress card	330
SDXC memory card	360
External SSD	280

When the interchangeable lens (H-FS12060) is used

Recording media	Number of pictures that can be taken
CFexpress card	350
SDXC memory card	380
External SSD	290

❖ Recording Pictures (When Using the Viewfinder)

When the interchangeable lens (H-ES12060) is used

Recording media	Number of pictures that can be taken
CFexpress card	330 (750)
SDXC memory card	360 (850)
External SSD	280

When the interchangeable lens (H-FS12060) is used

Recording media	Number of pictures that can be taken
CFexpress card	350 (800)
SDXC memory card	380 (900)
External SSD	290

- The numbers in parentheses indicate the values that result when [Time to Sleep] in [Power Save LVF Shooting] is set to [1SEC] and the [Power Save LVF Shooting] function works as intended.

(Based on the test conditions derived from the CIPA standard and specified by Panasonic)

❖ Recording Videos (When Using the Monitor)

- [Image Area of Video]: [FULL]

(A) Using a CFexpress card

(B) Using an SDXC memory card

When the interchangeable lens (H-ES12060) is used

[Rec. File Format]	[Rec Quality]	Recording media	Continuous available recording time (minutes)	Actual available recording time (minutes)
[MP4]	[4K/10bit/100M/60p]	(A)	90	45
	[4K/10bit/100M/50p]	(B)	90	45
	[FHD/8bit/20M/30p]	(A)	100	50
	[FHD/8bit/20M/25p]	(B)	100	50
[MOV]	[5.7K/60p/420/10-L]	(A)	50	25
	[5.7K/50p/420/10-L]	(B)	50	25
	[C4K/120p/420/10-L]	(A)	40	20
	[C4K/100p/420/10-L]	(B)	40	20
	[C4K/60p/422/10-I(H)]	(A)	80	40
	[C4K/50p/422/10-I(L)]	(B)	80	40
	[FHD/30p/420/10-L]	(A)	90	45
	[FHD/25p/420/10-L]	(B)	90	45
[Apple ProRes]	[5.7K/30p/RAW HQ]	(A)	50	25
		(B)		
	[5.7K/30p/422 HQ]	(A)	50	25
		(B)		
	[C4K/60p/RAW HQ]	(A)	60	30
		(B)		
	[C4K/60p/422 HQ]	(A)	50	25
		(B)		

- Actual available recording time is the time available for recording when repeating actions such as turning the camera on and off, starting/stopping recording, etc.

❖ Playback (When Using the Monitor)

When the interchangeable lens (H-ES12060) is used

Recording media	Playback time (minutes)
CFexpress card	240
SDXC memory card	240
External SSD	180

When the interchangeable lens (H-FS12060) is used

Recording media	Playback time (minutes)
CFexpress card	250
SDXC memory card	260
External SSD	180



- The number of pictures that can be taken and the available recording time vary depending on the surrounding environment and the usage conditions.
For example, these will reduce in the following case:
 - In low-temperature environments, such as on ski slopes.
- If the usage duration drops significantly even when the battery is fully charged, then the battery is at the end of its service life.
Replace with a new battery.

Number of Pictures That Can Be Taken and Video Recording Time According to Recording Media

Listed below are the numbers of pictures and the time lengths of videos that can be recorded on recording media.

- Using a Nextorage CFexpress Type B card.
- Using a Nextorage SDXC memory card.
- Using a Samsung external SSD.

❖ Number of Pictures That Can Be Taken

- The listed values are a guide to the minimum number of pictures to be taken.
This may vary depending on the recorded subject.
- **[Aspect Ratio]: [4:3]; [Picture Quality]: [FINE]**

[Picture Size]	CFexpress card capacity		SD card capacity		External SSD capacity	
	660 GB	1330 GB	256 GB	512 GB	1 TB	2 TB
[L] (25M)	41950	84560	16880	33130	63570	127160
[M] (12.5M)	74040	149220	31050	60920	112190	224400
[S] (6.5M)	125860	253660	53480	104920	190710	381460
[XS] (3M)	209750	422730	96250	188830	317830	635720

• **[Aspect Ratio]: [4:3]; [Picture Quality]: [RAW+FINE]**

[Picture Size]	CFexpress card capacity		SD card capacity		External SSD capacity	
	660 GB	1330 GB	256 GB	512 GB	1 TB	2 TB
[L] (25M)	8740	17610	3370	6620	13240	26490
[M] (12.5M)	9600	19360	3710	7290	14550	29120
[S] (6.5M)	10150	20450	3910	7670	15380	30760
[XS] (3M)	10480	21130	4040	7930	15890	31790

❖ Video Recording Time

- “h” is an abbreviation for hour, “m” for minute and “s” for second.
- Video recording time is the total time of all the videos which have been recorded.
- The values listed are approximate.
- **[Rec. File Format]: [MP4]**

[System Frequency]: [59.94Hz (NTSC)]						
[Rec Quality]	CFexpress card capacity		SD card capacity		External SSD capacity	
	660 GB	1330 GB	256 GB	512 GB	1 TB	2 TB
[4K/10bit/100M/60p] [4K/8bit/100M/30p] [4K/8bit/100M/24p]	14h35m	29h25m	5h30m	10h55m	22h05m	44h20m
[4K/10bit/72M/30p] [4K/10bit/72M/24p]	20h15m	40h55m	7h45m	15h10m	30h45m	61h30m
[FHD/8bit/28M/60p]	51h15m	103h20m	19h45m	38h50m	77h40m	155h25m
[FHD/8bit/20M/30p]	68h10m	137h35m	26h20m	51h45m	103h25m	206h55m
[FHD/8bit/24M/24p]	59h45m	120h30m	23h00m	45h20m	90h35m	181h15m

[System Frequency]: [50.00Hz (PAL)]						
[Rec Quality]	CFexpress card capacity		SD card capacity		External SSD capacity	
	660 GB	1330 GB	256 GB	512 GB	1 TB	2 TB
[4K/10bit/100M/50p] [4K/8bit/100M/25p]	14h35m	29h25m	5h30m	10h55m	22h05m	44h20m
[4K/10bit/72M/25p]	20h15m	40h55m	7h45m	15h10m	30h45m	61h30m
[FHD/8bit/28M/50p]	51h15m	103h20m	19h45m	38h50m	77h40m	155h25m
[FHD/8bit/20M/25p]	68h10m	137h35m	26h20m	51h45m	103h25m	206h55m

• [Rec. File Format]: [MOV]

[System Frequency]: [59.94Hz (NTSC)]						
[Rec Quality]	CFexpress card capacity		SD card capacity		External SSD capacity	
	660 GB	1330 GB	256 GB	512 GB	1 TB	2 TB
[C4K/60p/422/10-I(H)] [C4K/48p/422/10-I(H)] [4K/60p/422/10-I(H)] [4K/48p/422/10-I(H)] [FHD/240p/422/10-I]	1h45m	3h40m			2h45m	5h30m
[C4K/60p/422/10-I(L)] [C4K/48p/422/10-I(L)] [4K/60p/422/10-I(L)] [4K/48p/422/10-I(L)]	2h25m	4h50m	55m00s	1h45m	3h40m	7h20m
[C4K/30p/422/10-I] [C4K/24p/422/10-I] [4K/30p/422/10-I] [4K/24p/422/10-I] [FHD/120p/422/10-I]	3h35m	7h20m	1h20m	2h40m	5h30m	11h00m
[5.7K/60p/420/10-L] [5.7K/48p/420/10-L] [4.4K/60p/420/10-L] [4.4K/48p/420/10-L] [C4K/120p/420/10-L] [4K/120p/420/10-L]	4h50m	9h45m	1h50m	3h35m	7h20m	14h40m

[5.8K/30p/420/10-L] [5.8K/24p/420/10-L] [5.7K/30p/420/10-L] [5.7K/24p/420/10-L] [C4K/60p/422/10-L] [C4K/60p/420/10-L] [C4K/48p/422/10-L] [C4K/48p/420/10-L] [4K/60p/422/10-L] [4K/60p/420/10-L] [4K/48p/422/10-L] [4K/48p/420/10-L] [FHD/240p/422/10-L] [FHD/240p/420/10-L] [FHD/60p/422/10-I] [FHD/48p/422/10-I] [FHD/30p/422/10-I] [FHD/24p/422/10-I]	7h10m	14h35m	2h45m	5h25m	10h55m	21h55m
[C4K/60p/420/8-L] [C4K/30p/422/10-L] [C4K/30p/420/10-L] [C4K/24p/422/10-L] [C4K/24p/420/10-L] [4K/60p/420/8-L] [4K/30p/422/10-L] [4K/30p/420/10-L] [4K/24p/422/10-L] [4K/24p/420/10-L] [FHD/120p/422/10-L] [FHD/120p/420/10-L]	9h35m	19h20m	3h40m	7h10m	14h30m	29h05m

[C4K/30p/420/8-L] [C4K/24p/420/8-L] [4K/30p/420/8-L] [4K/24p/420/8-L] [FHD/60p/422/10-L] [FHD/60p/420/10-L] [FHD/60i/422/10-L] [FHD/48p/422/10-L] [FHD/48p/420/10-L] [FHD/30p/422/10-L] [FHD/30p/420/10-L] [FHD/24p/422/10-L] [FHD/24p/420/10-L]	14h15m	28h50m	5h25m	10h40m	21h40m	43h20m
[FHD/60p/420/8-L] [FHD/60i/422/10-L]	27h55m	56h25m	10h40m	20h55m	42h20m	84h50m
[FHD/30p/420/8-L] [FHD/24p/420/8-L]	53h30m	107h55m	20h25m	40h10m	81h05m	162h20m

[System Frequency]: [50.00Hz (PAL)]						
[Rec Quality]	CFexpress card capacity		SD card capacity		External SSD capacity	
	660 GB	1330 GB	256 GB	512 GB	1 TB	2 TB
[C4K/50p/422/10-I(H)] [4K/50p/422/10-I(H)] [FHD/200p/422/10-I]	1h45m	3h40m			2h45m	5h30m
[C4K/50p/422/10-I(L)] [4K/50p/422/10-I(L)]	2h25m	4h50m	55m00s	1h45m	3h40m	7h20m
[C4K/25p/422/10-I] [4K/25p/422/10-I] [FHD/100p/422/10-I]	3h35m	7h20m	1h20m	2h40m	5h30m	11h00m
[5.7K/50p/420/10-L] [4.4K/50p/420/10-L] [C4K/100p/420/10-L] [4K/100p/420/10-L]	4h50m	9h45m	1h50m	3h35m	7h20m	14h40m
[5.8K/25p/420/10-L] [5.7K/25p/420/10-L] [C4K/50p/422/10-L] [C4K/50p/420/10-L] [4K/50p/422/10-L] [4K/50p/420/10-L] [FHD/200p/422/10-L] [FHD/200p/420/10-L] [FHD/50p/422/10-I] [FHD/25p/422/10-I]	7h10m	14h35m	2h45m	5h25m	10h55m	21h55m
[C4K/50p/420/8-L] [C4K/25p/422/10-L] [C4K/25p/420/10-L] [4K/50p/420/8-L] [4K/25p/422/10-L] [4K/25p/420/10-L] [FHD/100p/422/10-L] [FHD/100p/420/10-L]	9h35m	19h20m	3h40m	7h10m	14h30m	29h05m

[C4K/25p/420/8-L] [4K/25p/420/8-L] [FHD/50p/422/10-L] [FHD/50p/420/10-L] [FHD/50i/422/10-I] [FHD/25p/422/10-L] [FHD/25p/420/10-L]	14h15m	28h50m	5h25m	10h40m	21h40m	43h20m
[FHD/50p/420/8-L] [FHD/50i/422/10-L]	27h55m	56h25m	10h40m	20h55m	42h20m	84h50m
[FHD/25p/420/8-L]	53h30m	107h55m	20h25m	40h10m	81h05m	162h20m

[System Frequency]: [24.00Hz (CINEMA)]						
[Rec Quality]	CFexpress card capacity		SD card capacity		External SSD capacity	
	660 GB	1330 GB	256 GB	512 GB	1 TB	2 TB
[C4K/24p/422/10-I] [4K/24p/422/10-I] [FHD/120p/422/10-I]	3h35m	7h20m	1h20m	2h40m	5h30m	11h00m
[5.7K/48p/420/10-L] [4.4K/48p/420/10-L] [C4K/120p/420/10-L] [4K/120p/420/10-L]	4h50m	9h45m	1h50m	3h35m	7h20m	14h40m
[5.8K/24p/420/10-L] [5.7K/24p/420/10-L] [FHD/24p/422/10-I]	7h10m	14h35m	2h45m	5h25m	10h55m	21h55m
[C4K/24p/422/10-L] [C4K/24p/420/10-L] [4K/24p/422/10-L] [4K/24p/420/10-L] [FHD/120p/422/10-L] [FHD/120p/420/10-L]	9h35m	19h20m	3h40m	7h10m	14h30m	29h05m
[C4K/24p/420/8-L] [4K/24p/420/8-L] [FHD/24p/422/10-L] [FHD/24p/420/10-L]	14h15m	28h50m	5h25m	10h40m	21h40m	43h20m
[FHD/24p/420/8-L]	53h30m	107h55m	20h25m	40h10m	81h05m	162h20m

• [Rec. File Format]: [Apple ProRes]

[System Frequency]: [59.94Hz (NTSC)]						
[Rec Quality]	CFexpress card capacity		SD card capacity		External SSD capacity	
	660 GB	1330 GB	256 GB	512 GB	1 TB	2 TB
[5.7K/30p/RAW HQ]	.				.	
[5.7K/30p/RAW]						
[5.7K/30p/422 HQ]	45m00s	1h30m			1h05m	2h15m
[5.7K/30p/422]	1h05m	2h15m			1h40m	3h25m
[5.7K/24p/RAW HQ]	.				.	
[5.7K/24p/RAW]						
[5.7K/24p/422 HQ]	57m00s	1h55m			1h25m	2h50m
[5.7K/24p/422]	1h25m	2h50m			2h10m	4h20m
[C4K/60p/RAW HQ]	.				.	
[C4K/60p/RAW]						
[C4K/60p/422 HQ]	44m00s	1h30m			1h05m	2h15m
[C4K/60p/422]	1h05m	2h15m			1h40m	3h25m
[C4K/30p/RAW HQ]	.				.	
[C4K/30p/RAW]						
[C4K/30p/422 HQ]	1h25m	3h00m			2h15m	4h30m
[C4K/30p/422]	2h10m	4h30m			3h20m	6h45m
[C4K/24p/RAW HQ]	.				.	
[C4K/24p/RAW]						
[C4K/24p/422 HQ]	1h50m	3h45m			2h50m	5h40m
[C4K/24p/422]	2h45m	5h35m			4h15m	8h30m
[FHD/60p/422 HQ]	3h10m	6h25m	1h10m	2h20m	4h50m	9h40m
[FHD/60p/422]	4h45m	9h40m	1h50m	3h35m	7h15m	14h35m
[FHD/30p/422 HQ]	6h20m	12h50m	2h25m	4h45m	9h40m	19h20m
[FHD/30p/422]	9h30m	19h15m	3h35m	7h05m	14h25m	28h55m
[FHD/24p/422 HQ]	7h55m	16h05m	3h00m	5h55m	12h05m	24h10m
[FHD/24p/422]	11h50m	23h55m	4h30m	8h50m	17h55m	36h00m

[System Frequency]: [50.00Hz (PAL)]						
[Rec Quality]	CFexpress card capacity		SD card capacity		External SSD capacity	
	660 GB	1330 GB	256 GB	512 GB	1 TB	2 TB
[5.7K/25p/RAW HQ]	.				.	
[5.7K/25p/RAW]						
[5.7K/25p/422 HQ]	55m00s	1h50m			1h20m	2h45m
[5.7K/25p/422]	1h20m	2h45m			2h05m	4h10m
[C4K/50p/RAW HQ]	.				.	
[C4K/50p/RAW]						
[C4K/50p/422 HQ]	53m00s	1h45m			1h20m	2h40m
[C4K/50p/422]	1h20m	2h40m			2h00m	4h05m
[C4K/25p/RAW HQ]	.				.	
[C4K/25p/RAW]						
[C4K/25p/422 HQ]	1h45m	3h35m			2h40m	5h25m
[C4K/25p/422]	2h40m	5h25m			4h05m	8h10m
[FHD/50p/422 HQ]	3h50m	7h45m	1h25m	2h50m	5h50m	11h40m
[FHD/50p/422]	5h45m	11h35m	2h10m	4h15m	8h40m	17h25m
[FHD/25p/422 HQ]	7h35m	15h25m	2h55m	5h40m	11h35m	23h10m
[FHD/25p/422]	11h20m	23h00m	4h20m	8h30m	17h15m	34h35m

[System Frequency]: [24.00Hz (CINEMA)]						
[Rec Quality]	CFexpress card capacity		SD card capacity		External SSD capacity	
	660 GB	1330 GB	256 GB	512 GB	1 TB	2 TB
[5.7K/24p/RAW HQ]	.				.	
[5.7K/24p/RAW]						
[5.7K/24p/422 HQ]	57m00s	1h55m			1h25m	2h50m
[5.7K/24p/422]	1h25m	2h50m			2h10m	4h20m
[C4K/24p/RAW HQ]	.				.	
[C4K/24p/RAW]						
[C4K/24p/422 HQ]	1h50m	3h45m			2h50m	5h40m
[C4K/24p/422]	2h45m	5h35m			4h15m	8h30m
[FHD/24p/422 HQ]	7h55m	16h00m	3h00m	5h55m	12h00m	24h05m
[FHD/24p/422]	11h50m	23h55m	4h30m	8h50m	17h55m	36h00m

* Recording stops when 640 GB is reached.

Guide to recording time with 640 GB

[C4K/60p/RAW HQ]: Approx. 20 minutes











- The available recording time will be shorter depending on the SD card used when recording with [Segmented File Recording] or [Loop Recording (video)].
- The number of pictures that can be taken and the available video recording time depend on the recording conditions and the type of recording media.
- [9999+] is displayed on the recording screen if the remaining number of pictures that can be taken is 10000 or more.
- [99h59m] is displayed on the recording screen if the remaining video recording time is 100 hours or more.
- The continuous recordable time for videos is displayed on the screen.

List of Default Settings/Custom Saving/ Settings Available for Copying







: Using [Reset], the function to return to default settings







: Using [Save to Custom Mode], the function to save settings details in the Custom mode











: Using [Save/Restore Camera Setting], the function to copy settings details







Menu		Default setting			
 [Photo]:  [Image Quality]					
[Photo Style]		[ STD.]	✓	✓	✓
[Metering Mode]		[ M]	✓	✓	✓
[Aspect Ratio]		[4:3]	✓	✓	✓
[Picture Quality]		[FINE]	✓	✓	✓
[Picture Size]		[L] (25M)	✓	✓	✓
[High Resolution Mode Setting]	[Handheld High-Res]	[OFF]	✓	✓	✓
	[Picture Quality]	[COMBINED]	✓	✓	✓
	[Picture Size]	[XL]	✓	✓	✓
	[Simul Record Normal Shot]	[ON]	✓	✓	✓
	[Shutter Delay]	[2 SEC]	✓	✓	✓
	[Motion Blur Processing]	[MODE1]	✓	✓	✓
[Long Exposure NR]		[ON]	✓	✓	✓
[ISO Sensitivity (photo)]	[ISO Auto Lower Limit Setting]	[100]	✓	✓	✓
	[ISO Auto Upper Limit Setting]	[AUTO]	✓	✓	✓
[Synchro Scan(Photo)]		[OFF]	✓	✓	✓





[Min. Shutter Speed]	[AUTO]	✓	✓	✓	
[i.Dynamic Range]	[OFF]	✓	✓	✓	
[Vignetting Comp.]	[OFF]	✓	✓	✓	
[Diffraction Compensation]	[OFF]	✓	✓	✓	
[Filter Settings]	[Filter Effect]	[OFF]	✓	✓	✓
	[Simultaneous Record w/o Filter]	[OFF]	✓	✓	✓

Menu		Default setting			
 [Photo]:  [Focus]					
[AF Detection Setting]		[OFF]	✓	✓	✓
[Detecting Subject]	[Type of Subject]	[HUMAN]	✓	✓	✓
	[Target Parts]	[]	✓	✓	✓
[AF Custom Setting(Photo)]		[Set 1]	✓	✓	✓
[Focus Limiter]	[ON] / [OFF]	[OFF]	✓	✓	✓
	[SET]	—	✓	✓	✓
[AF Assist Light]		[ON]	✓	✓	✓
[Focus Peaking]	[ON] / [OFF]	[ON]	✓	✓	✓
	[SET]	—	✓	✓	✓
[Focus Frame Moving Speed]		[FAST]	✓	✓	✓







Menu	Default setting			
 [Photo]:  [Flash]				
[Flash Mode]	[]	✓	✓	✓
[Firing Mode]	[TTL]	✓	✓	✓
[Flash Adjust.]	[±0 EV]	✓	✓	✓
[Flash Synchro]	[1ST]	✓	✓	✓
[Manual Flash Adjust.]	[1/1]	✓	✓	✓
[Auto Exposure Comp.]	[OFF]	✓	✓	✓
[Wireless]	[OFF]	✓	✓	✓
[Wireless Channel]	[1CH]	✓	✓	✓
[Wireless FP]	[OFF]	✓	✓	✓
[Communication Light]	[HIGH]	✓	✓	✓
[Wireless Setup]	—	✓	✓	✓





Menu		Default setting			
 [Photo]:  [Others (Photo)]					
[Bracketing]	[Bracketing Type]	[OFF]	✓	✓	✓
	[More Settings]	—	✓	✓	✓
[Silent Mode]		[OFF]	✓	✓	✓
[Crop Zoom(Photo)]	[ON] / [OFF]	[OFF]	✓	✓	✓
	[SET]	—	✓	✓	✓
[Image Stabilizer]	[Operation Mode]	[((()))]	✓	✓	✓
	[E-Stabilization (Video)]	[OFF]	✓	✓	✓
	[Boost I.S. (Video)]	[OFF]	✓	✓	✓
	[Anamorphic (Video)]	[OFF]	✓	✓	✓
	[Lens Information]	[Lens1]	✓		✓
[Burst Shot Setting]	[Burst Shot 1 Setting]	[H]	✓	✓	✓
	[Burst Shot 2 Setting]	[SH75]	✓	✓	✓
	[SH Burst Pre-Recording Time]	[0.5SEC]	✓	✓	✓
[Shutter Type]		[MECH.]	✓	✓	✓
[Shutter Delay]		[OFF]	✓	✓	✓
[Time Lapse/ Animation]	[Mode]	[Time Lapse Shot]	✓	✓	✓
	[Shooting Interval Setting]	[ON]	✓	✓	✓
	[Start Time]	[Now]	✓	✓	✓
	[Image Count]	[1]	✓	✓	✓
	[Shooting Interval]	[1m00s]	✓	✓	✓
	[Exposure Leveling]	[OFF]	✓	✓	✓
	[Create New Folder At Rec]	—	✓	✓	✓
[Live View Composite]	[Start]	—			
	[Shutter Delay]	[OFF]	✓	✓	✓
[Self Timer]	[] / [] / [] / [] to []	[]	✓	✓	✓
	[SET]	—	✓	✓	✓







Menu		Default setting			
 [Video]:  [Image Quality]					
[Exposure Mode]		[P]	✓	✓	✓
[Photo Style]		[ STD.]	✓	✓	✓
[Metering Mode]		[]	✓	✓	✓
[ISO Sensitivity (video)]	[ISO Auto Lower Limit Setting]	[100]	✓	✓	✓
	[ISO Auto Upper Limit Setting]	[AUTO]	✓	✓	✓
[Synchro Scan(Video)]		[OFF]	✓	✓	✓
[Flicker Decrease (Video)]		[OFF]	✓	✓	✓
[Master Pedestal Level]		[0]	✓	✓	✓
[SS/Gain Operation]		[SEC/ISO]	✓	✓	✓
[i.Dynamic Range]		[OFF]	✓	✓	✓
[Vignetting Comp.]		[OFF]	✓	✓	✓
[Diffraction Compensation]		[OFF]	✓	✓	✓
[Filter Settings]	[Filter Effect]	[OFF]	✓	✓	✓
	[Simultaneous Record w/o Filter]	[OFF]	✓	✓	✓











Menu	Default setting			
 [Video]:  [Image Format]				
[Rec. File Format]	When [System Frequency] is set to [59.94Hz (NTSC)] or [50.00Hz (PAL)]: [MP4]	✓	✓	✓
	When [System Frequency] is set to [24.00Hz (CINEMA)]: [MOV]			
[Image Area of Video]	[FULL]	✓	✓	✓
[Rec Quality]	When [System Frequency] is set to [59.94Hz (NTSC)]: [4K/8bit/100M/30p]			
	When [System Frequency] is set to [50.00Hz (PAL)]: [4K/8bit/100M/25p]	✓	✓	✓
	When [System Frequency] is set to [24.00Hz (CINEMA)]: [4K/24p/420/10-L]			
[Rec Quality (My List)]	—	✓	✓	✓
[Variable Frame Rate]	[OFF]	✓	✓	✓







[Proxy Recording Settings]	[Proxy Recording]	[OFF]	✓	✓	✓
	[Proxy Rec. Quality]	[M]	✓	✓	✓
	[Real Time LUT(Proxy)]	[OFF]	✓	✓	✓
[Time Code]	[Time Code Display]	[OFF]	✓	✓	✓
	[Count Up]	[REC RUN]	✓	✓	✓
	[Time Code Value]	—			
	[Time Code Mode]	[DF]	✓	✓	✓
	[HDMI Time Code Output]	[OFF]	✓	✓	✓
	[External TC Setting]	—	✓	✓	✓
[Luminance Level]	[16-235]	✓	✓	✓	
[HDMI RAW Data Output]	[OFF]	✓	✓	✓	

Menu		Default setting			
 [Video]:  [Focus]					
[AF Detection Setting]		[OFF]	✓	✓	✓
[Detecting Subject]	[Type of Subject]	[HUMAN]	✓	✓	✓
	[Target Parts]	[]	✓	✓	✓
[AF Custom Setting(Video)]	[ON] / [OFF]	[OFF]	✓	✓	✓
	[SET]	—	✓	✓	✓
[Focus Limiter]	[ON] / [OFF]	[OFF]	✓	✓	✓
	[SET]	—	✓	✓	✓
[Continuous AF]		[MODE1]	✓	✓	✓
[AF Assist Light]		[ON]	✓	✓	✓
[Focus Peaking]	[ON] / [OFF]	[ON]	✓	✓	✓
	[SET]	—	✓	✓	✓
[Focus Frame Moving Speed]		[FAST]	✓	✓	✓

Menu		Default setting			
 [Video]:  [Audio]					
[Sound Rec Level Disp.]	[ON] / [OFF]	[OFF]	✓	✓	✓
	[SET]	—	✓	✓	✓
[Mute Sound Input]		[OFF]	✓	✓	✓
[Sound Rec Gain Level]		[STANDARD]	✓	✓	✓
[Sound Rec Level Adj.]		[0dB]	✓	✓	✓
[Sound Rec Quality]		[48kHz/24bit]	✓	✓	✓
[Sound Rec Level Limiter]		[ON]	✓	✓	✓
[Wind Noise Canceller]		[STANDARD]	✓	✓	✓
[Wind Cut]		[OFF]	✓	✓	✓
[Lens Noise Cut]		[ON]	✓	✓	✓
[Mic Socket]		[MIC]	✓	✓	✓
[Special Mic.]		[STEREO]	✓	✓	✓
[4ch Audio Recording]		[OFF]	✓	✓	✓
[XLR Mic Adaptor Setting]		[ON]	✓	✓	✓
[Sound Output]		[REALTIME]	✓	✓	✓
[Headphone Volume]		[LEVEL3]	✓		✓
[Sound Monitoring Channel]		[CH1/CH2]	✓	✓	✓





Menu		Default setting			
 [Video]:  [Others (Video)]					
[Silent Mode]		[OFF]	✓	✓	✓
[Crop Zoom(Video)]	[ON] / [OFF]	[OFF]	✓	✓	✓
	[SET]	—	✓	✓	✓
[Image Stabilizer]	[Operation Mode]	[]	✓	✓	✓
	[E-Stabilization (Video)]	[OFF]	✓	✓	✓
	[Boost I.S. (Video)]	[OFF]	✓	✓	✓
	[Anamorphic (Video)]	[OFF]	✓	✓	✓
	[Lens Information]	[Lens1]	✓		✓
[Self Timer Setting]	[Self Timer]	[ 10]	✓	✓	✓
	[Self Timer For Video]	[OFF]	✓	✓	✓
[Focus Transition]	[Focus Position Setting]	—			
	[Focus Transition Speed]	[M]	✓	✓	✓
	[Focus Transition Rec]	[OFF]	✓	✓	✓
	[Focus Transition Wait]	[OFF]	✓	✓	✓
[Loop Recording (video)]		[OFF]	✓	✓	✓
[Segmented File Recording]		[OFF]	✓	✓	✓
[Live Cropping]		[OFF]	✓	✓	✓





























Menu		Default setting			
 [Custom]:  [Image Quality]					
[Photo Style Settings]	[Show/Hide Photo Style]	—	✓	✓	✓
	[My Photo Style Settings]	—	✓	✓	✓
	[Reset Photo Style]	—			
[LUT Library]		—	✓		✓
[ISO Increments]		[1/3 EV]	✓	✓	✓
[Extended ISO]		[OFF]	✓	✓	✓
[Exposure Offset Adjust.]	[Multi Metering]	[±0EV]	✓	✓	✓
	[Center Weighted]	[±0EV]	✓	✓	✓
	[Spot]	[±0EV]	✓	✓	✓
	[Highlight Weighted]	[±0EV]	✓	✓	✓
[Face Priority In Multi Metering]		[ON]	✓	✓	✓
[AWB Lock Setting]	[Operation Syncs With Shutter]	[OFF]	✓	✓	✓
	[Lock Hold With Fn Button]	[ON]	✓	✓	✓
[Color Space]		[sRGB]	✓	✓	✓
[Exposure Comp. Reset]		[OFF]	✓		✓
[Auto Exposure in P/A/S/M]		[ON]	✓	✓	✓
[CreativeVideo Combined Set.]	[F/SS/ISO/Exposure Comp.]	[]	✓	✓	✓
	[White Balance]	[]	✓	✓	✓
	[Photo Style]	[]	✓	✓	✓
	[Metering Mode]	[]	✓	✓	✓
	[AF Mode]	[]	✓	✓	✓









Menu		Default setting			
 [Custom]:  [Focus/Shutter]					
[Focus/Shutter Priority]	[AFS]	[FOCUS]	✓	✓	✓
	[AFC]	[BALANCE]	✓	✓	✓
[Focus Switching for Vert / Hor]		[OFF]	✓	✓	✓
[AF/AE Lock Hold]		[OFF]	✓	✓	✓
[AF+MF]		[OFF]	✓	✓	✓
[MF Assist]	[Focus Ring]	[ON]	✓	✓	✓
	[AF Mode]	[ON]	✓	✓	✓
	[Press Joystick]	[OFF]	✓	✓	✓
	[MF Assist Display]	[PIP]	✓	✓	✓
[MF Guide]		[] / [] ^{*1}	✓	✓	✓
[Focus Ring Lock]		[OFF]	✓	✓	✓
[Show/Hide AF Mode]	[Tracking]	[ON]	✓	✓	✓
	[Full Area AF]	[ON]	✓	✓	✓
	[Zone(Horizontal/Vertical)]	[ON]	✓	✓	✓
	[Zone]	[ON]	✓	✓	✓
	[1-Area+]	[ON]	✓	✓	✓
	[Pinpoint]	[ON]	✓	✓	✓
[Pinpoint AF Setting]	[Pinpoint AF Time]	[MID]	✓	✓	✓
	[Pinpoint AF Display]	[PIP]	✓	✓	✓
[AF-Point Scope Setting]	[Keep Enlarged Display]	[OFF]	✓	✓	✓
	[PIP Display]	[PIP]	✓	✓	✓







[Shutter AF]	[ON]	✓	✓	✓	
[Human Eye Detection Display]	[ON]	✓	✓	✓	
[Half-Press Shutter]	[OFF]	✓	✓	✓	
[Assign REC to Shutter Button]	[ON]	✓	✓	✓	
[Quick AF]	[OFF]	✓	✓	✓	
[Eye Sensor AF]	[OFF]	✓	✓	✓	
[Looped Focus Frame]	[OFF]	✓	✓	✓	
[Enlarged Live Display(Video)]	[Keep Enlarged Display]	[ON]	✓	✓	✓
	[PIP Display]	[PIP]	✓	✓	✓





*1 Default setting specifications vary depending on the country or area where the camera was purchased.





Menu		Default setting			
 [Custom]:  [Operation]					
[Q.MENU Settings]	[Layout Style]	[MODE1]	✓	✓	✓
	[Front Dial Assignment]	[Value]	✓	✓	✓
	[Item Customize (Photo)]	—	✓	✓	✓
	[Item Customize (Video)]	—	✓	✓	✓
[Touch Settings]	[Touch Screen]	[ON]	✓	✓	✓
	[Touch Tab]	[OFF]	✓	✓	✓
	[Touch AF]	[AF]	✓	✓	✓
	[Touch Pad AF]	[OFF]	✓	✓	✓





	[AF ON] button	[]	✓	✓	✓
	Joystick	[]	✓	✓	✓
	[Q] button	[]	✓	✓	✓
	Cursor buttons / [MENU/ SET] button	[]	✓	✓	✓
	Control dial	[]	✓	✓	✓
	[] (AF mode) button	[]	✓	✓	✓
	[] (Playback) button	[]	✓	✓	✓
	Touch screen	[]	✓	✓	✓
	[] (Cancel) button / [] (Delete) button / Fn button (Fn1)	[]	✓	✓	✓
	[DISP.] button	[]	✓	✓	✓
	[] (Exposure compensation) button	[]	✓	✓	✓
[Lock Lever Setting]	[ISO] button	[]	✓	✓	✓
	[] (Audio information) button	[]	✓	✓	✓
	Rear dial	[]	✓	✓	✓
	Video rec. button	[]	✓	✓	✓
	Front dial	[]	✓	✓	✓
	[WB] button	[]	✓	✓	✓
	[LVF] button	[]	✓	✓	✓
	Shutter button	[]	✓	✓	✓
	Sub video rec. button	[]	✓	✓	✓
	Lens	[]	✓	✓	✓
	Enlarged live display (video) button / Fn button (Fn2)	[]	✓	✓	✓
	Preview button / Fn button (Fn3)	[]	✓	✓	✓

[Fn Button Set]	[Setting in REC mode]	—	✓	✓	✓
	[Setting in PLAY mode]	—	✓	✓	✓
[WB/ISO/Expo. Button]		[AFTER PRESSING2]	✓	✓	✓
[ISO Displayed Setting]	[Front/Rear Dials]	[ / 	✓	✓	✓
[Exposure Comp. Disp. Setting]	[Cursor Buttons (Up/Down)]	[OFF]	✓	✓	✓
	[Front/Rear Dials]	[ / 	✓	✓	✓
[Dial Set.]	[Assign Dial (F/SS)]	[SET1]	✓	✓	✓
	[Rotation (F/SS)]	[ 	✓	✓	✓
	[Control Dial Assignment]	[	✓	✓	✓
	[Exposure Comp.]	[OFF]	✓	✓	✓
	[Dial Operation Switch Setup]	—	✓	✓	✓
	[Rotation (Menu Operation)]	[ 	✓	✓	✓
[Joystick Setting]		[D.FOCUS Movement]	✓	✓	✓
[Video Rec. Button (Remote)]		[Video Record]	✓	✓	✓

Menu		Default setting			
 [Custom]:  [Monitor / Display (Photo)]					
[Auto Review]	[Duration Time (photo)]	[OFF]	✓	✓	✓
	[Playback Operation Priority]	[OFF]	✓	✓	✓
[Constant Preview]	[ON] / [OFF]	[OFF]	✓	✓	✓
	[SET]	—	✓	✓	✓
[Histogram]		[OFF]	✓	✓	✓
[Photo Grid Line]		[OFF]	✓	✓	✓
[Live View Boost]	[MODE1] / [MODE2] / [OFF]	[OFF]	✓	✓	✓
	[SET]	[M]	✓	✓	✓
[Night Mode]	[Monitor]	[OFF]	✓	✓	✓
	[LVF]	[OFF]	✓	✓	✓
[LVF/Monitor Disp. Set]	[LVF Disp. Set]		✓	✓	✓
	[Monitor Disp. Set]		✓	✓	✓
	[Horizontal Image Flip(Monitor)]	[AUTO]	✓	✓	✓
	[Vertical Image Flip(Monitor)]	[AUTO]	✓	✓	✓
[Expo.Meter]		[OFF]	✓	✓	✓
[Focal Length]		[ON]	✓	✓	✓
[Blinking Highlights]		[OFF]	✓	✓	✓
[Sheer Overlay]	[ON] / [OFF]	[OFF]	✓		
	[SET]	—	✓		
[I.S. Status Scope]		[OFF]	✓	✓	✓
[Level Gauge]		[ON]	✓	✓	✓
[Luminance Spot Meter]		[OFF]	✓	✓	✓
[Framing Outline]		[OFF]	✓	✓	✓
[Show/Hide Monitor Layout]	[Control Panel]	[ON]	✓	✓	✓
	[Black Screen]	[ON]	✓	✓	✓









Menu		Default setting			
 [Custom]:  [Monitor / Display (Video)]					
[Log View Assist]	[LUT Select(V-Log)]	[Vlog_709]	✓	✓	✓
	[LUT Select(ARRI LogC3)]	[ARRI 709]	✓	✓	✓
	[LUT View Assist (Monitor)]	[OFF]	✓	✓	✓
	[LUT View Assist (HDMI)]	[OFF]	✓	✓	✓
[HLG View Assist]	[Monitor]	[MODE2]	✓	✓	✓
	[HDMI]	[AUTO]	✓	✓	✓
[Anamorphic Desqueeze Display]		[OFF]	✓	✓	✓
[Monochrome Live View]		[OFF]	✓	✓	✓
[Center Marker]		[OFF]	✓	✓	✓
[Safety Zone Marker]		[OFF]	✓	✓	✓
[Frame Marker]	[ON] / [OFF]	[OFF]	✓	✓	✓
	[SET]	—	✓	✓	✓
[Zebra Pattern]	[ZEBRA1] / [ZEBRA2] / [ZEBRA1+2] / [OFF]	[OFF]	✓	✓	✓
	[SET]	—	✓	✓	✓
[WFM/Vector Scope]		[OFF]	✓	✓	✓
[Color Bars]		[SMPTE]	✓	✓	✓
[Video-Priority Display]		[OFF]	✓	✓	✓
[Red REC Frame Indicator]		[OFF]	✓	✓	✓
[Streaming Blue Frame Indicator]		[OFF]	✓	✓	✓





Menu		Default setting			
 [Custom]:  [IN/OUT]					
[HDMI Rec Output]	[Info Display]	[OFF]	✓	✓	✓
	[Down Convert]	[AUTO]	✓	✓	✓
	[HDMI Recording Control]	[OFF]	✓	✓	✓
	[Sound Output (HDMI)]	[ON]	✓	✓	✓
	[Enlarged Live Display]	[OFF]	✓	✓	✓
	[4K/120p Output] / [4K/100p Output]	[OFF]	✓	✓	✓
	[4K/120p Power Save Live View] / [4K/100p Power Save Live View]	[OFF]	✓	✓	✓
[Fan Mode]	[AUTO2]	✓	✓	✓	
[Tally Lamp]	[Front Tally Lamp]	[H]	✓	✓	✓
	[Rear Tally Lamp]	[L]	✓	✓	✓











Menu		Default setting			
 [Custom]:  [Lens / Others]					
[Lens Focus Resume]		[OFF]	✓	✓	✓
[Power Zoom Lens]	[Step Zoom]	[OFF]	✓	✓	✓
	[Zoom Speed(Photo)]	[M]	✓	✓	✓
	[Zoom Speed(Video)]	[M]	✓	✓	✓
	[Zoom Ring]	[ON]	✓	✓	✓
[Lens Fn Button Setting]		[Focus Stop]	✓	✓	✓
[Aperture Ring Increment]		[1/3EV]	✓	✓	✓
[Focus Ring Control]	[NON-LINEAR] / [LINEAR]	[NON-LINEAR]	✓	✓	✓
	[SET]	[300°]	✓	✓	✓
[AF Micro Adjustment]		[OFF]	✓	✓ ^{*1}	✓ ^{*2}
[Lens Information]		[Lens1]	✓		✓
[Lens Info. Confirmation]		[ON]	✓	✓	✓
[Vertical Position Info (Video)]		[ON]	✓	✓	✓

*1 The adjustment value for the focus point cannot be registered.

*2 The settings information cannot be loaded onto a camera different from the one where the camera settings were saved.

Menu		Default setting			
 [Setup]:  [Card/File]					
[Card Format]		—			
[Double Card Slot Function]	[Recording Method]		✓		✓
	[Destination Card Slot]	[ → ]	✓		✓
[USB-SSD]		[OFF]	✓		
[Video File Name]		[Same As Photo(DCF Standard)]	✓		✓
[CINE Style File Setting]	[Camera Index]	[A]	✓		✓
	[Next Card Number]	[001]	✓		✓
[Folder / File Settings]	[Select Folder]	—			
	[Create a New Folder]	—			
	[File Name Setting]	[Folder Number Link]	✓		✓
[File Number Reset]		—			
[Copyright Information]	[Artist]	[OFF]	✓		✓
	[Copyright Holder]	[OFF]	✓		✓
	[Display Copyright Info.]	—			

Menu		Default setting			
 [Setup]:  [Monitor / Display]					
[Power Save Mode]	[Sleep Mode]	[1MIN.]	✓		✓
	[Sleep Mode(Wi-Fi)]	[ON]	✓		✓
	[Auto LVF/Monitor Off]	[1MIN.]	✓		✓
	[Power Save LVF Shooting]	—	✓		✓
[Thermal Management]	[Recording Max Temperature]	[STANDARD]	✓		✓
[Monitor Frame Rate]		[60fps]	✓		✓
[LVF Frame Rate]		[60fps]	✓		✓
[Monitor Settings] / [Viewfinder]		—	✓		
[Monitor Backlight] / [LVF Luminance]		[AUTO]	✓		✓
[Eye Sensor]	[Sensitivity]	[HIGH]	✓		✓
	[LVF/Monitor Switch]	[LVF/MON AUTO]	✓		✓
[Level Gauge Adjust.]	[Adjust.]	—	✓		
	[Level Gauge Value Reset]	—			





Menu		Default setting			
 [Setup]:  [IN/OUT]					
[Beep]	[Beep Volume]	[]	✓		✓
	[AF Beep Volume]	[]	✓		✓
	[AF Beep Tone]	[]	✓		✓
	[E-Shutter Vol]	[]	✓		✓
	[E-Shutter Tone]	[]	✓		✓
[Headphone Volume]		[LEVEL3]	✓		✓
[Sound Monitoring Channel(Play)]		[COMBINED WITH REC]	✓	✓	✓
[Streaming]	[Streaming Function]	[OFF]			
	[Streaming Method]	[Direct]	✓		✓
	[Connection Method]	[Wi-Fi]	✓		✓
	[Streaming Setup]	—	✓		✓ ^{*1}
[LAN / Wi-Fi]	[Wi-Fi Function]	—	✓		
	[LAN / Wi-Fi Setup]	—	✓		✓ ^{*2}
[Bluetooth]		—	✓		
[USB]	[USB Mode]	[] [Select on connection]	✓		✓
	[USB Power Supply]	[ON]	✓		✓
	[Tether(USB ethernet adaptor)]	[OFF]	✓		✓
[Frame.io]	[Frame.io Connection]	[OFF]	✓		
	[Send Images to Frame.io]	—			
	[Connection Setup]	—	✓		
	[Upload Setup]	—	✓		





[HDMI Connection]	[Output Resolution(Playback)]	[AUTO]	✓		✓
	[LUT View Assist (HDMI)]	[OFF]	✓	✓	✓
	[HLG View Assist (HDMI)]	[AUTO]	✓	✓	✓
	[VIERA Link (CEC)]	[OFF]	✓		✓
	[Background Color(Playback)]	[■]	✓		✓
	[Photo Luminance Level]	[16-255]	✓		✓
[Power/Network Indicator]		[ON]	✓		✓

*1 [Streaming Quality] and [RTSP Port] settings are saved.

*2 [IP Address Setting (LAN)] setting in [LAN / Wi-Fi Setup] is saved.





However, the IP address set in [Static IP Address Setting] is not saved.





Menu		Default setting			
 [Setup]:  [Setting]					
[Save to Custom Mode]		—	✓		✓
[Load Custom Mode]		—	✓		✓
[Custom Mode Settings]	[Limit No. of Custom Mode]	[3]	✓		✓
	[Edit Title]	—	✓		✓
	[How to Reload Custom Mode]	—	✓		✓
	[Select Loading Details]	—	✓		✓
[Save/Restore Camera Setting]	[Save]	—			
	[Load]	—			
	[Delete]	—			
	[Keep Settings While Format]	[OFF]	✓		✓
[Reset]		—			
[Activate]	[Export Serial Code]	—			
	[Import Activation Code]	—			
	[Activation List]	—			





Menu	Default setting			
 [Setup]:  [Others]				
[Clock Set]	0:00:00 1/1/2024			
[Time Zone]	*1			✓
[System Frequency]	[59.94Hz (NTSC)] / [50.00Hz (PAL)] ^{*1}	✓		✓
[Pixel Refresh]	—			
[Sensor Cleaning]	—			
[Language]	*1	✓		✓
[Firmware Version]	—			
[Approved Regulations] ^{*2}	—			
[Root Certificate]	—			





*1 Default setting specifications vary depending on the country or area where the camera was purchased.





*2 Depending on the country or area where the camera was purchased, this is not displayed due to differences in specifications.





Menu	Default setting			
 [My Menu]:  [Edit My Menu]				
[Add]	—	✓		✓
[Sorting]	—			
[Delete]	—			
[Display from My Menu]	[OFF]	✓		✓

Menu	Default setting			
 [Playback]:  [Playback Mode]				
[Playback Mode]	[Normal Play]	✓		✓
[Slide Show]	—	✓		✓
[Rotate Disp.]	[ON]	✓		✓
[Picture Sort]	[DATE/TIME]	✓		✓
[Magnify from AF Point]	[OFF]	✓		✓
[LUT View Assist (Monitor)]	[OFF]	✓	✓	✓
[HLG View Assist (Monitor)]	[MODE2]	✓	✓	✓
[Anamorphic Desqueeze Display]	[OFF]	✓	✓	✓
[Behavior After Video Playback]	[End Playback]	✓		✓

Menu	Default setting			
 [Playback]:  [Process Image]				
[RAW Processing]	—			
[Time Lapse Video]	—			
[Stop Motion Video]	—			



Menu	Default setting			
 [Playback]:  [Add/Delete Info.]				
[Protect]	—			
[Rating]	—			



Menu	Default setting			
 [Playback]:  [Edit Image]				
[Resize]	—			
[Rotate]	—			
[Video Divide]	—			
[Copy]	—			
[Video Repair]	—			



Menu	Default setting			
 [Playback]:  [Others]				
[Delete Confirmation]	["No" first]	<input checked="" type="checkbox"/>	<input type="checkbox"/>	<input checked="" type="checkbox"/>
[Delete All Images]	—			



List of Functions That Can Be Set in Each Recording Mode



Menu		iA	P	A	S	M	
 [Photo]:  [Image Quality]							
[Photo Style]		✓	✓	✓	✓	✓	
[Metering Mode]			✓	✓	✓	✓	
[Aspect Ratio]		✓	✓	✓	✓	✓	
[Picture Quality]		✓	✓	✓	✓	✓	
[Picture Size]		✓	✓	✓	✓	✓	
[High Resolution Mode Setting]	[Handheld High-Res]		✓	✓	✓	✓	
	[Picture Quality]		✓	✓	✓	✓	
	[Picture Size]		✓	✓	✓	✓	
	[Simul Record Normal Shot]		✓	✓	✓	✓	
	[Shutter Delay]		✓	✓	✓	✓	
	[Motion Blur Processing]		✓	✓	✓	✓	
[Long Exposure NR]			✓	✓	✓	✓	
[ISO Sensitivity (photo)]	[ISO Auto Lower Limit Setting]		✓	✓	✓	✓	
	[ISO Auto Upper Limit Setting]		✓	✓	✓	✓	
[Synchro Scan(Photo)]					✓	✓	
[Min. Shutter Speed]			✓	✓			
[i.Dynamic Range]			✓	✓	✓	✓	
[Vignetting Comp.]			✓	✓	✓	✓	
[Diffraction Compensation]			✓	✓	✓	✓	
[Filter Settings]	[Filter Effect]		✓	✓	✓	✓	
	[Simultaneous Record w/ o Filter]		✓	✓	✓	✓	



Menu		iA	P	A	S	M	
 [Photo]:  [Focus]							
[AF Detection Setting]			✓	✓	✓	✓	
[Detecting Subject]	[Type of Subject]		✓	✓	✓	✓	
	[Target Parts]		✓	✓	✓	✓	
[AF Custom Setting(Photo)]			✓	✓	✓	✓	
[Focus Limiter]		✓	✓	✓	✓	✓	
[AF Assist Light]			✓	✓	✓	✓	
[Focus Peaking]	[ON] / [OFF]	✓	✓	✓	✓	✓	
	[SET]	✓	✓	✓	✓	✓	
[Focus Frame Moving Speed]		✓	✓	✓	✓	✓	



Menu		iA	P	A	S	M	
 [Photo]:  [Flash]							
[Flash Mode]		✓	✓	✓	✓	✓	
[Firing Mode]			✓	✓	✓	✓	
[Flash Adjust.]			✓	✓	✓	✓	
[Flash Synchro]			✓	✓	✓	✓	
[Manual Flash Adjust.]			✓	✓	✓	✓	
[Auto Exposure Comp.]			✓	✓	✓	✓	
[Wireless]			✓	✓	✓	✓	
[Wireless Channel]			✓	✓	✓	✓	
[Wireless FP]			✓	✓	✓	✓	
[Communication Light]			✓	✓	✓	✓	
[Wireless Setup]			✓	✓	✓	✓	



Menu		iA	P	A	S	M	
 [Photo]:  [Others (Photo)]							
[Bracketing]	[Bracketing Type]	✓	✓	✓	✓	✓	
	[More Settings]	✓	✓	✓	✓	✓	
[Silent Mode]		✓	✓	✓	✓	✓	
[Crop Zoom(Photo)]		✓	✓	✓	✓	✓	
[Image Stabilizer]	[Operation Mode]	✓	✓	✓	✓	✓	
	[E-Stabilization (Video)]	✓	✓	✓	✓	✓	
	[Boost I.S. (Video)]	✓	✓	✓	✓	✓	
	[Anamorphic (Video)]	✓	✓	✓	✓	✓	
	[Lens Information]	✓	✓	✓	✓	✓	
[Burst Shot Setting]	[Burst Shot 1 Setting]	✓	✓	✓	✓	✓	
	[Burst Shot 2 Setting]	✓	✓	✓	✓	✓	
	[SH Burst Pre-Recording Time]	✓	✓	✓	✓	✓	
[Shutter Type]		✓	✓	✓	✓	✓	
[Shutter Delay]		✓	✓	✓	✓	✓	
[Time Lapse/Animation]		✓	✓	✓	✓	✓	
[Live View Composite]	[Start]					✓	
	[Shutter Delay]					✓	
[Self Timer]		✓	✓	✓	✓	✓	

Menu		iA	P	A	S	M	M
 [Video]:  [Image Quality]							
[Exposure Mode]							✓
[Photo Style]		✓	✓	✓	✓	✓	✓
[Metering Mode]			✓	✓	✓	✓	✓
[ISO Sensitivity (video)]	[ISO Auto Lower Limit Setting]						✓
	[ISO Auto Upper Limit Setting]						✓
[Synchro Scan(Video)]							✓
[Flicker Decrease (Video)]			✓	✓	✓	✓	
[Master Pedestal Level]							✓
[SS/Gain Operation]							✓
[i.Dynamic Range]			✓	✓	✓	✓	✓
[Vignetting Comp.]			✓	✓	✓	✓	✓
[Diffraction Compensation]			✓	✓	✓	✓	✓
[Filter Settings]	[Filter Effect]		✓	✓	✓	✓	✓
	[Simultaneous Record w/o Filter]		✓	✓	✓	✓	

Menu		iA	P	A	S	M	
 [Video]:  [Image Format]							
[Rec. File Format]		✓	✓	✓	✓	✓	✓
[Image Area of Video]		✓	✓	✓	✓	✓	✓
[Rec Quality]		✓	✓	✓	✓	✓	✓
[Rec Quality (My List)]		✓	✓	✓	✓	✓	✓
[Variable Frame Rate]							✓
[Proxy Recording Settings]	[Proxy Recording]	✓	✓	✓	✓	✓	✓
	[Proxy Rec. Quality]	✓	✓	✓	✓	✓	✓
	[Real Time LUT(Proxy)]	✓	✓	✓	✓	✓	✓
[Time Code]	[Time Code Display]	✓	✓	✓	✓	✓	✓
	[Count Up]	✓	✓	✓	✓	✓	✓
	[Time Code Value]	✓	✓	✓	✓	✓	✓
	[Time Code Mode]	✓	✓	✓	✓	✓	✓
	[HDMI Time Code Output]						✓
	[External TC Setting]						✓
[Luminance Level]		✓	✓	✓	✓	✓	✓
[HDMI RAW Data Output]							✓

Menu		iA	P	A	S	M	
 [Video]:  [Focus]							
[AF Detection Setting]			✓	✓	✓	✓	✓
[Detecting Subject]	[Type of Subject]		✓	✓	✓	✓	✓
	[Target Parts]		✓	✓	✓	✓	✓
[AF Custom Setting(Video)]	[ON] / [OFF]	✓	✓	✓	✓	✓	✓
	[SET]	✓	✓	✓	✓	✓	✓
[Focus Limiter]	[OFF]	✓	✓	✓	✓	✓	✓
[Continuous AF]		✓	✓	✓	✓	✓	✓
[AF Assist Light]			✓	✓	✓	✓	✓
[Focus Peaking]	[ON] / [OFF]	✓	✓	✓	✓	✓	✓
	[SET]	✓	✓	✓	✓	✓	✓
[Focus Frame Moving Speed]		✓	✓	✓	✓	✓	✓

Menu	iA	P	A	S	M	M
 [Video]:  [Audio]						
[Sound Rec Level Disp.]	✓	✓	✓	✓	✓	✓
[Mute Sound Input]	✓	✓	✓	✓	✓	✓
[Sound Rec Gain Level]	✓	✓	✓	✓	✓	✓
[Sound Rec Level Adj.]	✓	✓	✓	✓	✓	✓
[Sound Rec Quality]	✓	✓	✓	✓	✓	✓
[Sound Rec Level Limiter]	✓	✓	✓	✓	✓	✓
[Wind Noise Canceller]	✓	✓	✓	✓	✓	✓
[Wind Cut]	✓	✓	✓	✓	✓	✓
[Lens Noise Cut]	✓	✓	✓	✓	✓	✓
[Mic Socket]	✓	✓	✓	✓	✓	✓
[Special Mic.]	✓	✓	✓	✓	✓	✓
[4ch Audio Recording]	✓	✓	✓	✓	✓	✓
[XLR Mic Adaptor Setting]	✓	✓	✓	✓	✓	✓
[Sound Output]	✓	✓	✓	✓	✓	✓
[Headphone Volume]	✓	✓	✓	✓	✓	✓
[Sound Monitoring Channel]	✓	✓	✓	✓	✓	✓

Menu		iA	P	A	S	M	
 [Video]:  [Others (Video)]							
[Silent Mode]		✓	✓	✓	✓	✓	✓
[Crop Zoom(Video)]							✓
[Image Stabilizer]	[Operation Mode]	✓	✓	✓	✓	✓	✓
	[E-Stabilization (Video)]	✓	✓	✓	✓	✓	✓
	[Boost I.S. (Video)]	✓	✓	✓	✓	✓	✓
	[Anamorphic (Video)]	✓	✓	✓	✓	✓	✓
	[Lens Information]	✓	✓	✓	✓	✓	✓
[Self Timer Setting]	[Self Timer]	✓	✓	✓	✓	✓	✓
	[Self Timer For Video]	✓	✓	✓	✓	✓	✓
[Focus Transition]							✓
[Loop Recording (video)]							✓
[Segmented File Recording]		✓	✓	✓	✓	✓	✓
[Live Cropping]							✓

Specifications

The specifications are subject to change for performance enhancement.

Digital camera body (DC-GH7):

Information for your safety

Power source:

9.0 V===

Power consumption:

4.8 W (when recording with the monitor), 3.8 W (when playing back with the monitor)

[When using the interchangeable lens (H-ES12060)]

4.6 W (when recording with the monitor), 3.6 W (when playing back with the monitor)

[When using the interchangeable lens (H-FS12060)]

Type

● Type

Digital Single Lens Mirrorless camera

● Lens mount

Micro Four Thirds Mount

● Recording media

Card slot 1: CFexpress Type B card

Card slot 2: SD memory card / SDHC memory card^{*1} / SDXC memory card^{*1}

^{*1} Compliant with UHS-I/UHS-II UHS Speed Class 3, UHS-II Video Speed Class 90

Double slot recording function is available.

Image sensor

- **Image sensor**

4/3" BSI CMOS image sensor, a total of approx. 26,500,000 pixels, primary color filter

- **Effective number of pixels of the camera**

Approx. 25,200,000 pixels

Latitude

13+ stops (sensor output 60 fps or lower), 12+ stops (sensor output 61 fps or higher) ([V-Log])

Recording format for still images

- **File format for still images**

JPEG (DCF compliant, Exif 3.0 compliant) / RAW

- **Picture size (pixels)**

When the aspect ratio setting is [4:3]

[L]: 5776×4336

[M]: 4096×3072

[S]: 2944×2208

[XS]: 1920×1440

High Resolution mode ([XL]): 11552×8672

High Resolution mode ([LL]): 8192×6144

When the aspect ratio setting is [3:2]

[L]: 5776×3848

[M]: 4096×2728

[S]: 2944×1960

[XS]: 1920×1280

High Resolution mode ([XL]): 11552×7696

High Resolution mode ([LL]): 8192×5464

When the aspect ratio setting is [16:9]

[L]: 5776×3248

[M]: 4096×2304

[S]: 2944×1656

[XS]: 1920×1080

High Resolution mode ([XL]): 11552×6496

High Resolution mode ([LL]): 8192×4608

When the aspect ratio setting is [1:1]

[L]: 4336×4336

[M]: 3072×3072

[S]: 2208×2208

[XS]: 1440×1440

High Resolution mode ([XL]): 8672×8672

High Resolution mode ([LL]): 6144×6144

● **Image quality for pictures**

Fine / Standard / RAW+Fine / RAW+Standard / RAW

Recording format for video

● Video format

MP4 (H.264/MPEG-4 AVC, H.265/HEVC)

MOV (H.264/MPEG-4 AVC, H.265/HEVC, Apple ProRes, Apple ProRes RAW)

● Audio compression format

When [OFF] is selected for [4ch Audio Recording]

MP4 Linear format: AAC (2ch stereo 48 kHz/16 bit)

MOV Linear format: LPCM (2ch stereo 48 kHz/24 bit, 96 kHz/24 bit)^{*2}

Float format: LPCM (2ch stereo 48 kHz/32 bit, 96 kHz/32 bit)^{*3}

When [XLR] is selected for [4ch Audio Recording]

MOV Linear format: LPCM (4ch monaural 48 kHz/24 bit)^{*3}

Float format: LPCM (4ch monaural 48 kHz/32 bit)^{*3}

When [XLR+CAMERA] is selected for [4ch Audio Recording]

MOV Linear format: LPCM (4ch monaural 48 kHz/24 bit, 96 kHz/24 bit)^{*2, 3}

*2 Supports only 48 kHz when using the built-in microphone

*3 When the XLR Microphone Adaptor DMW-XLR2 is attached

● System frequency

59.94 Hz / 50.00 Hz / 24.00 Hz

● Image quality for video

Refer to the “[Rec Quality]” pages for information about resolution, recording frame rate, and other elements of recording quality. (→[Rec Quality]: 142)

Viewfinder

- **Type**

Aspect ratio 4:3, 0.5 inches, approx. 3,680,000 dots, organic EL (OLED) live view viewfinder

- **Field of view ratio**

Approx. 100 %

- **Magnification**

Approx. 1.6×, Approx. 0.8× (35 mm film camera equivalent), -1.0 m^{-1} 50 mm at infinity, with aspect ratio set to [4:3]

- **Eye point**

Approx. 21 mm (at -1.0 m^{-1})

- **Diopter adjustment range**

-4.0 to +2.0 diopter

- **Eye sensor**

Yes

Monitor

- **Type**

Aspect ratio 3:2, 3.0 inches, approx. 1,840,000 dots monitor, capacitive touch screen

- **Field of view ratio**

Approx. 100 %

Focus

- **AF type**

TTL type based on image detection (image plane phase detection AF/contrast AF)

- **Focus mode**

AFS / AFC / MF

- **AF mode**

Tracking*⁴ / Full Area AF*⁴ / Zone (Horizontal/Vertical)*⁴ / Zone*⁴ /

1-Area+Supplementary*⁴ / 1-Area*⁴ / Pinpoint

Focus area selection is possible by touching or with the joystick

*⁴ Automatic detection (Human, Animal, Car, Motorcycle, Train, Airplane) can be switched ON/OFF

- **AF Micro Adjustment**

Yes (All / Adjust By Lens)

Exposure control

- **Light metering system, Light metering mode**

1728-zone metering, multi-metering / center-weighted metering / spot metering / highlight-weighted metering

- **Metering range**

EV 0 to EV 18 (F2.0 lens, ISO100 conversion)

- **Exposure**

Program AE (P) / Aperture-Priority AE (A) / Shutter-Priority AE (S) / Manual Exposure (M)

- **Exposure compensation**

1/3 EV steps, ±5 EV

- **ISO sensitivity for still images (standard output sensitivity)**

Normal: AUTO / 50*⁵ / 100 to 25600

[V-Log]: AUTO / 125*⁵ to 400*⁵ / 500 to 12800

*⁵ When [Extended ISO] is set

- Switchable between 1/3 EV and 1 EV steps

● **ISO sensitivity for video (standard output sensitivity)**

Normal:

Sensor output 60 fps or lower: AUTO / 50^{*6} / 100 to 12800 (base sensitivity ISO100)

Sensor output 61 fps or higher: AUTO / 50^{*6} / 100 to 3200 / 4000^{*6} to 12800^{*6} (base sensitivity ISO100)

[V-Log]:

Sensor output 60 fps or lower: AUTO / 125^{*6} to 400^{*6} / 500 to 12800 (base sensitivity ISO500)

Sensor output 61 fps or higher: AUTO / 125^{*6} to 200^{*6} / 250 to 3200 / 4000^{*6} to 12800^{*6} (base sensitivity ISO250)

[ARRI LogC3]:

Sensor output 60 fps or lower: AUTO / 320 to 12800 (base sensitivity ISO320)

Sensor output 61 fps or higher: AUTO / 160 to 3200 / 4000^{*6} to 12800^{*6} (base sensitivity ISO160)

[Hybrid Log Gamma]:

Sensor output 60 fps or lower: AUTO / 250 to 12800 (base sensitivity ISO250)

Sensor output 61 fps or higher: AUTO / 250 to 3200 / 4000^{*6} to 12800^{*6} (base sensitivity ISO250)

*6 When [Extended ISO] is set

- Switchable between 1/3 EV and 1 EV steps

Image stabilizer

● **Image stabilizer type**

Compliant with Image sensor shift type, 5-axis stabilizer, Dual I.S.2

● **Image stabilizer effect**

In-body image stabilizer: 7.5 stops

[Focal length f=60 mm (35 mm film camera equivalent f=120 mm), using an interchangeable lens (H-ES12060)]

Dual I.S.2: 7.5 stops

[Focal length f=140 mm (35 mm film camera equivalent f=280 mm), using an interchangeable lens (H-FSA14140)]

(Based on the CIPA standard, Yaw/Pitch direction)

White balance

- **White balance mode**

AWB / AWBc / AWBw / Daylight / Cloudy / Shade / Incandescent lights / Flash / Set mode 1, 2, 3, 4 / Color temperature 1, 2, 3, 4
AWB lock supported

Shutter

- **Type**

Focal-plane shutter

- **Shutter speed**

Pictures:

Mechanical shutter: Bulb (max. approx. 30 minutes), 60 seconds to 1/8000 of a second

Electronic front curtain: Bulb (max. approx. 30 minutes), 60 seconds to 1/2000 of a second

Electronic shutter: Bulb (max. approx. 60 seconds), 60 seconds to 1/32000 of a second

Videos:

1/25^{*7} of a second to 1/25000 of a second

*7 When [Exposure Mode] is set to [M] in Creative Video mode and focus mode is set to [MF], this can be set up to 1/8 of a second

- **Flash synchronization speed**

Equal to or smaller than 1/250 of a second

Burst recording

- **Mechanical shutter**

High speed: 14 frames/second ([AFS], [MF]) / 10 frames/second ([AFC])

Medium speed: 6 frames/second ([AFS], [AFC], [MF])

Low speed: 2 frames/second ([AFS], [AFC], [MF])

- **Electronic front curtain**

High speed: 14 frames/second ([AFS], [MF]) / 9 frames/second ([AFC])

Medium speed: 6 frames/second ([AFS], [AFC], [MF])

Low speed: 2 frames/second ([AFS], [AFC], [MF])

- **Electronic shutter**

[SH75]/[SH75 PRE]: 75 frames/second ([AFS], [MF])

[SH60]/[SH60 PRE]: 60 frames/second ([AFS], [AFC], [MF])

[SH20]/[SH20 PRE]: 20 frames/second ([AFS], [AFC], [MF])

High speed: 14 frames/second ([AFS], [MF]) / 9 frames/second ([AFC])

Medium speed: 6 frames/second ([AFS], [AFC], [MF])

Low speed: 2 frames/second ([AFS], [AFC], [MF])

- **Maximum number of frames recordable (SH burst recording)**

[FINE] / [STD.] / [RAW+FINE] / [RAW+STD.] / [RAW]: 190 frames

- **Maximum number of frames recordable (High speed, medium speed, low speed)**

[FINE] / [STD.]: 260 frames or more^{*8} / 250 frames or more^{*9}

[RAW+FINE] / [RAW+STD.]: 170 frames or more^{*8} / 165 frames or more^{*9}

[RAW]: 215 frames or more^{*8} / 200 frames or more^{*9}

*8 Using a Nextorage CFexpress Type B card

*9 Using a Nextorage SDXC memory card compliant with UHS-II UHS Speed Class

3

(When recording is performed under the test conditions specified by Panasonic)

Zoom

- **Crop Zoom (Photo)**

Max. approx. 3× ([Minimum Image Size]: when [XS] is selected)

- **Crop Zoom (Video)**

Max. approx. 2.7× ([Rec Quality]: when FHD video is selected)

Microphone / Speaker

- **Microphone**

Stereo

- **Speaker**

Monaural

Interface

- **USB**

USB Type-C®, SuperSpeed USB 10Gbps (USB 3.2 Gen 2)

Supports USB Power Delivery (9.0 V/3.0 A)

Output: DC 5 V, 900 mA

- **HDMI**

HDMI Type A

- **[REMOTE]**

Ø2.5 mm jack

- **[MIC]**

Ø3.5 mm stereo mini jack

Mic Input (Plug-in Power) / Mic Input / Line Input (Operate the menu to switch between these inputs)

Standard input level: -55 dBV (Mic Input) / -10 dBV (Line Input)

- **Headphones**

Ø3.5 mm stereo mini jack

- **Flash Synchro**

Yes

- **TC IN/OUT**

Yes (connect the BNC conversion cable (supplied) to the flash synchro socket)

Input: 1.0 V to 4.0 V [p-p], 10 kΩ

Output: 2.0 V ±0.5 V [p-p], low impedance

Splash Resistant

Yes

Output of RAW video data via HDMI

Yes

Recording to an external SSD

Yes

Streaming

- **Wireless IP streaming**

Supported protocols: RTMP/RTMPS

- **USB tethering with a smart device**

Supported protocols: RTMP/RTMPS

- **Wired IP streaming**

Supported protocols: RTP/RTSP

External dimensions / Mass (Weight)

- **External dimensions**

Approx. 138.4 mm (W)×100.3 mm (H)×99.6 mm (D)

(5.45" (W)×3.95" (H)×3.92" (D))

(excluding the projecting parts)

- **Mass (Weight)**

Approx. 805 g/1.77 lb (camera body, with battery and one card)

Approx. 721 g/1.59 lb (only camera body)

Operating environment

- **Recommended operating temperature**

-10 °C to 40 °C (14 °F to 104 °F)

- Battery performance temporarily worsens at low temperatures (-10 °C to 0 °C (14 °F to 32 °F)), reducing the number of pictures that can be taken and the available recording time.

- **Permissible relative humidity**

10 %RH to 80 %RH

Wi-Fi

- **Compliance standard**

IEEE 802.11a/b/g/n/ac (standard wireless LAN protocol)

- **Frequency range used (central frequency)**

Specifications vary depending on the country or area where the camera was purchased.

Refer to the “Operating Instructions / Owner’s Manual <Quick Start Guide>” (supplied) for details.

- **Encryption method**

Wi-Fi compliant WPA™ / WPA2™ / WPA3™

- **Access method**

Infrastructure mode

Bluetooth

- **Compliance standard**

Bluetooth v5.0, Bluetooth Low Energy (BLE)

- **Frequency range used (central frequency)**

2402 MHz to 2480 MHz

The symbols on this product (including the accessories) represent the following:



DC



Hot surfaces

Interchangeable Lens:

H-ES12060 “LEICA DG VARIO-ELMARIT 12-60mm/F2.8-4.0 ASPH./ POWER O.I.S.”

- **Mount**

Micro Four Thirds Mount

- **Focal length**

f=12 mm to 60 mm

(35 mm film camera equivalent: 24 mm to 120 mm)

- **Lens construction**

14 elements in 12 groups (4 aspherical lenses, 2 ED lenses)

- **Aperture type**

9 diaphragm blades/circular aperture diaphragm

- **Maximum aperture**

F2.8 (Wide) to F4.0 (Tele)

- **Minimum aperture value**

F22

- **Angle of view**

84° (Wide) to 20° (Tele)

- **In focus distance**

0.20 m (0.66 feet) to ∞ (Wide)/0.24 m (0.79 feet) to ∞ (Tele) (from the focus distance reference line)

- **Maximum image magnification**

0.3× (35 mm film camera equivalent: 0.6×)

- **Optical Image Stabilizer**

Yes

- **Filter diameter**
62 mm
- **Maximum diameter**
Ø68.4 mm (2.7")
- **Overall length**
Approx. 86 mm (3.4") (from the tip of the lens to the base side of the lens mount)
- **Mass (Weight)**
Approx. 320 g (0.70 lb)
- **Dust and splash resistant**
Yes
- **Recommended operating temperature**
-10 °C to 40 °C (14 °F to 104 °F)
- **Permissible relative humidity**
10 %RH to 80 %RH

Interchangeable Lens:

H-FS12060 “LUMIX G VARIO 12-60mm/F3.5-5.6 ASPH./POWER O.I.S.”

- **Mount**

Micro Four Thirds Mount

- **Focal length**

f=12 mm to 60 mm

(35 mm film camera equivalent: 24 mm to 120 mm)

- **Lens construction**

11 elements in 9 groups (3 aspherical lenses, 1 ED lens)

- **Aperture type**

7 diaphragm blades/circular aperture diaphragm

- **Maximum aperture**

F3.5 (Wide) to F5.6 (Tele)

- **Minimum aperture value**

F22

- **Angle of view**

84° (Wide) to 20° (Tele)

- **In focus distance**

0.20 m (0.66 feet) to ∞ (Wide)/0.25 m (0.82 feet) to ∞ (Tele) (from the focus distance reference line)

- **Maximum image magnification**

0.27× (35 mm film camera equivalent: 0.54×)

- **Optical Image Stabilizer**

Yes

- **Filter diameter**
58 mm
- **Maximum diameter**
Ø66.0 mm (2.6")
- **Overall length**
Approx. 71 mm (2.8") (from the tip of the lens to the base side of the lens mount)
- **Mass (Weight)**
Approx. 210 g (0.46 lb)
- **Dust and splash resistant**
Yes
- **Recommended operating temperature**
0 °C to 40 °C (32 °F to 104 °F)
- **Permissible relative humidity**
10 %RH to 80 %RH

Trademarks and Licenses

- Micro Four Thirds™ and Micro Four Thirds Logo marks are trademarks or registered trademarks of OM Digital Solutions Corporation, in Japan, the United States, the European Union and other countries.



- "Nextorage" is a registered trademark or trademark of Nextorage corporation.
- SDXC Logo is a trademark of SD-3C, LLC.



- The terms HDMI, HDMI High-Definition Multimedia Interface, HDMI Trade dress and the HDMI Logos are trademarks or registered trademarks of HDMI Licensing Administrator, Inc.



- USB Type-C® and USB-C® are registered trademarks of USB Implementers Forum.
- The USB Type-C® Charging Trident Logos are trademarks of USB Implementers Forum, Inc.



- The SuperSpeed USB 10Gbps Trident Logo is a registered trademark of USB Implementers Forum, Inc.



- QuickTime and the QuickTime logo are trademarks or registered trademarks of Apple Inc., used under license therefrom.



- HDAVI Control™ is a trademark of Panasonic Holdings Corporation.
- Adobe is a trademark or registered trademark of Adobe Systems Incorporated in the United States and/or other countries.
- Frame.io, the Frame.io logo and Camera to Cloud are either registered trademarks or trademarks of Adobe in the United States and/or other countries.
- Windows is a registered trademark or trademark of Microsoft Corporation in the United States and/or other countries.
- Apple, Final Cut Pro, Mac, macOS, and ProRes are trademarks or registered trademarks of Apple Inc. in the United States and/or other countries.
- App Store is a service mark of Apple Inc.
- Google, Android and Google Play are trademarks of Google LLC.

- The Bluetooth® word mark and logos are registered trademarks owned by Bluetooth SIG, Inc. and any use of such marks by Panasonic Holdings Corporation is under license. Other trademarks and trade names are those of their respective owners.
- “Wi-Fi®” is a registered trademark of Wi-Fi Alliance®.
- “WPA™”, “WPA2™”, and “WPA3™” are trademarks of Wi-Fi Alliance®.
- QR Code is a registered trademark of DENSO WAVE INCORPORATED.
- “ATOMOS”, “ATOMOS NINJA”, “SHOGUN” and “ATOMOS SHOGUN” are registered trademarks of Atomos Limited.
- ‘Blackmagic Design’ is a registered trademark of Blackmagic Design Pty. Ltd.
- ARRI is a registered trademark of Arnold & Richter Cine Technik GmbH & Co. Betriebs KG.
- Samsung is the registered trademark of Samsung Electronics Co., Ltd.
- LEICA is a registered trademark of Leica Microsystems IR GmbH. ELMARIT is a registered trademark of Leica Camera AG. The LEICA DG lenses are manufactured using measurement instruments and quality assurance systems that have been certified by Leica Camera AG based on the company’s quality standards.
- Other names, company names, product names mentioned in this document are trademarks or registered trademarks of the companies concerned.



This product incorporates the following software:

- (1) the software developed independently by or for Panasonic,
- (2) the software owned by third party and licensed to Panasonic,
- (3) the software licensed under the GNU General Public License, Version 2.0 (GPL V2.0),
- (4) the software licensed under the GNU LESSER General Public License, Version 2.1 (LGPL V2.1), and/or
- (5) open source software other than the software licensed under the GPL V2.0 and/or LGPL V2.1.

The software categorized as (3) - (5) are distributed in the hope that it will be useful, but WITHOUT ANY WARRANTY, without even the implied warranty of MERCHANTABILITY or FITNESS FOR A PARTICULAR PURPOSE. Please refer to the detailed terms and conditions thereof displayed by selecting [MENU/SET] ➔ [Setup] ➔ [Others] ➔ [Firmware Version] ➔ [Software info].

At least three (3) years from delivery of this product, Panasonic will give to any third party who contacts us at the contact information provided below, for a charge no more than our cost of physically performing source code distribution, a complete machine-readable copy of the corresponding source code covered under GPL V2.0 or LGPL V2.1, as well as the respective copyright notice thereof.

Contact Information: oss-cd-request@gg.jp.panasonic.com

The source code and the copyright notice are also available for free in our website below.

<https://panasonic.net/cns/oss/index.html>

This product is licensed under the AVC Patent Portfolio License for the personal use of a consumer or other uses in which it does not receive remuneration to (i) encode video in compliance with the AVC Standard ("AVC Video") and/or (ii) decode AVC Video that was encoded by a consumer engaged in a personal activity and/or was obtained from a video provider licensed to provide AVC Video. No license is granted or shall be implied for any other use. Additional information may be obtained from MPEG LA, L.L.C.

See <http://www.mpegla.com>

Disposal of Old Equipment and Batteries

Only for European Union and countries with recycling systems



These symbols on the products, packaging, and/or accompanying documents mean that used electrical and electronic products and batteries must not be mixed with general household waste.

For proper treatment, recovery and recycling of old products and used batteries, please take them to applicable collection points in accordance with your national legislation.

By disposing of them correctly, you will help to save valuable resources and prevent any potential negative effects on human health and the environment.

For more information about collection and recycling, please contact your local authority.

Penalties may be applicable for incorrect disposal of this waste, in accordance with national legislation.



Note for the battery symbol (bottom symbol):

This symbol might be used in combination with a chemical symbol. In this case it complies with the requirement set by the Directive for the chemical involved.